

STAMFORD®

SX460 Automatic Voltage Regulator (AVR)
**SPECIFICATION, CONTROLS AND
ACCESSORIES**

Table of Contents

| | |
|-----------------------|----|
| 1. DESCRIPTION..... | 1 |
| 2. SPECIFICATION..... | 3 |
| 3. CONTROLS..... | 5 |
| 4. ACCESSORIES..... | 11 |

-

This page is intentionally blank.

1 Description

1.1 Self-Excited AVR Controlled Alternators

1.1.1 Main Stator Powered AVR

The AVR provides closed loop control by sensing the alternator output voltage at the main stator windings and adjusting the exciter stator field strength. Voltage induced in the exciter rotor, rectified by the rotating diodes, magnetises the rotating main field which induces voltage in the main stator windings. A self-excited AVR receives power from the alternator output terminals.

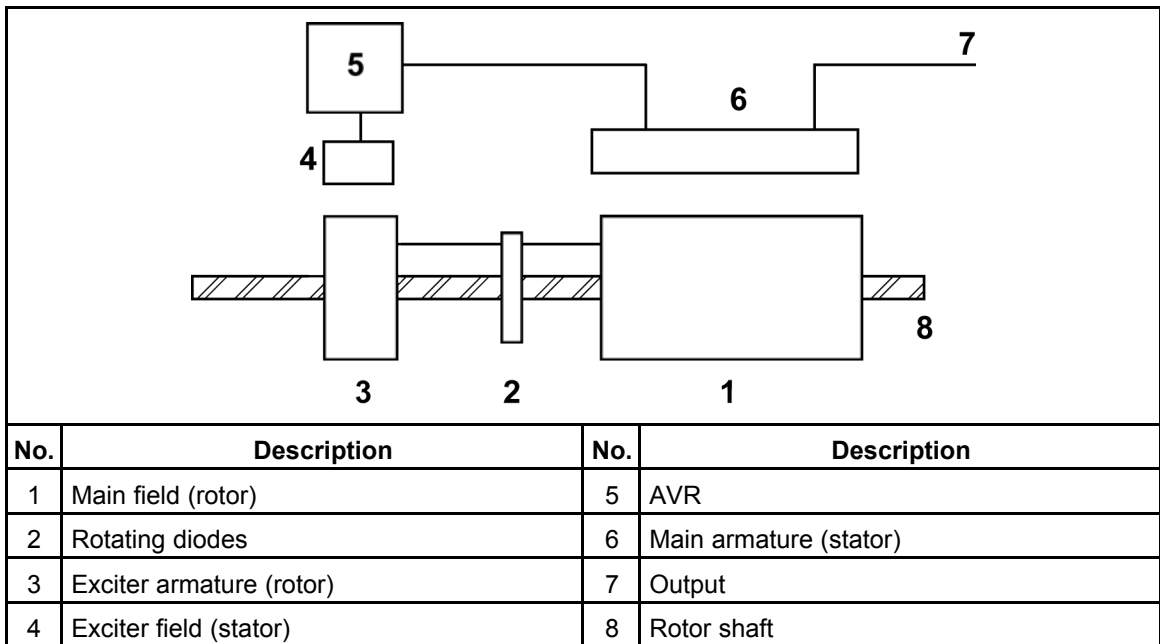

1.1.2 Transformer-Controlled Alternators

The main stator provides power for excitation of the exciter stator via a transformer rectifier unit. The transformer combines voltage and current elements derived from the main stator output to form the basis of an open-loop control system, which is self regulating in nature. The system inherently compensates for load current magnitude and power factor and provides short circuit maintenance in addition to a good motor starting performance. Three-phase alternators normally have a three-phase transformer control for improved performance with unbalanced loads but a single-phase transformer option is available. No accessories can be provided with this control system.

-

This page is intentionally blank.

2 Specification

2.1 SX460 Technical Specification

- **Sensing Input**
 - Voltage: 95 VAC to 132 VAC or 190 VAC to 264 VAC, 1 phase¹
 - Frequency: 50 Hz to 60 Hz nominal
- **Power Input**
 - Voltage: 95 VAC to 264 VAC maximum, 1 phase
 - Frequency: 50 Hz to 60 Hz nominal
- **Power Output**
 - Voltage: maximum 90 VDC at 207 VAC input
 - Current
 - continuous 4 A
 - Intermittent 6 A for 10 seconds
 - Resistance: 15 Ω minimum
- **Regulation**
 - +/- 1.0% r.m.s.²
- **Thermal Drift**
 - 0.05% per 1 °C change in AVR ambient temperature³
- **Typical Response**
 - AVR response in 20 ms
 - Field current to 90% in 80 ms
 - Machine Volts to 97% in 300 ms
- **External Voltage Adjustment**
 - +/-10% with 1 k Ω , 1 W trimmer⁴
- **Under-Frequency Protection**
 - Set point 95% Hz ⁵

¹ jumper selectable

² With 4% engine governing

³ After 10 minutes.

⁴ Applies to Mod status F onwards. Generator de-rate may apply. Check with factory

⁵ Factory set, semi-sealed, jumper selectable.

-
- Slope 170% down to 30 Hz
 - **Unit Power Dissipation**
 - 10 W maximum
 - **Build-up Voltage**
 - 4 VAC at AVR terminals
 - **Environmental**
 - Vibration
 - 20 Hz to 100 Hz: 50 mm/sec
 - 100 Hz to 2 kHz: 3.3 g
 - Operating temperature: -40 °C to +70 °C
 - Relative Humidity 0 °C to 70 °C: 95%⁶
 - Storage temperature: -55 °C to +80 °C

⁶ Non condensing

3 Controls

 **DANGER**

Live Electrical Conductors

Live electrical conductors can cause serious injury or death by electric shock and burns.

To prevent injury and before removing covers over electrical conductors, isolate the generator set from all energy sources, remove stored energy and use lock out/tag out safety procedures.

 **DANGER**

Live Electrical Conductors

Live electrical conductors at output, AVR and AVR accessory terminals, and AVR heat sink can cause serious injury or death by electric shock and burns.

To prevent injury, take suitable precautions to prevent contact with live conductors including personal protective equipment, insulation, barriers and insulated tools.

NOTICE

Refer to alternator wiring diagram for connection details.

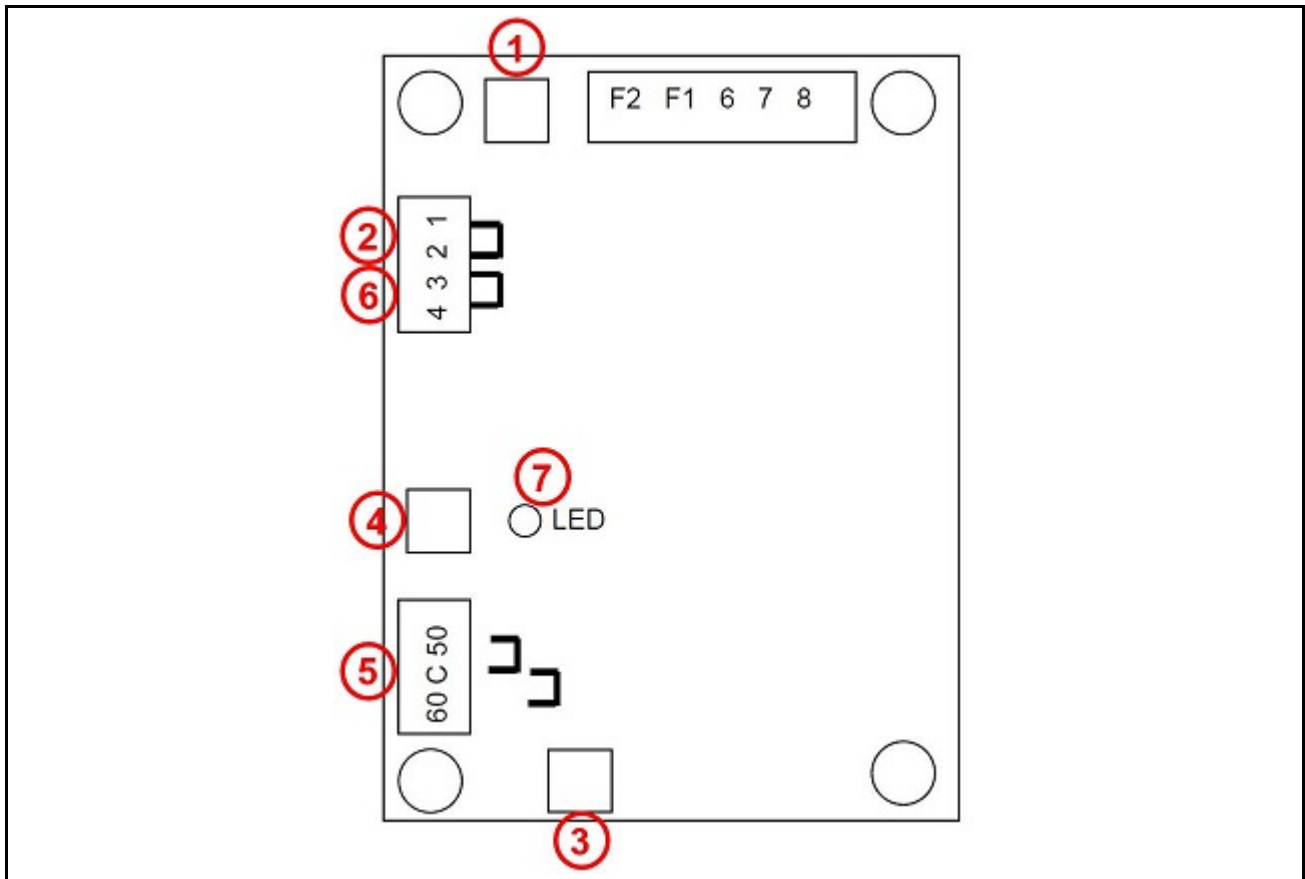

| Ref. | Control | Function | Turn potentiometer CLOCKWISE to |
|------|---|--|------------------------------------|
| 1 | AVR [VOLTS] | Adjust alternator output voltage | increase voltage |
| 2 | Link : Hand trimmer 1-2 : No trimmer None : Trimmer fitted | Adjust alternator output voltage | increase voltage |
| 3 | AVR [STAB] | Adjust stability to prevent voltage hunting | increase damping effect |
| 4 | AVR [UFRO] | Adjust the under-frequency roll-off knee point | reduce UFRO frequency |
| 5 | Link : Frequency 50-C : 50 Hz 60-C: 60 Hz | Select alternator frequency for UFRO | N/A |
| 6 | Link : Supply 3-4 : 110/120 VAC None: 240 VAC | Select AVR supply voltage | N/A |
| 7 | Light Emitting Diode | LED lights in UFRO condition | N/A |

FIGURE 1. SX460 AVR CONTROLS

3.2 Initial AVR Setup

NOTICE

The AVR must be setup only by authorised, trained service engineers. Do not exceed the designed safe operating voltage, shown on the alternator rating plate.

The AVR controls are set at the factory for initial running tests. Check that the AVR settings are compatible with your required output. Do not adjust controls that have been sealed. To set up a replacement AVR, follow these steps:

1. Stop and isolate the generator set.
2. Install and connect the AVR.
3. Turn the **AVR [VOLTS]** volts control [Section 3.3 on page 7](#) fully counter-clockwise.
4. Turn the hand trimmer (if fitted) to 50%, the midway position.
5. Turn the **AVR [STAB]** stability control [Section 3.4 on page 8](#) to 50%, the midway position.
6. Connect a suitable voltmeter (0 to 300 VAC range) between one output phase and neutral.
7. Start the generator set with no load.
8. Adjust speed to nominal frequency (50 to 53 Hz or 60 to 63 Hz).
9. If the LDE is lit, adjust the **AVR [UFRO]** control [Section 3.5 on page 9](#).
10. Carefully turn **AVR [VOLTS]** control clockwise until the voltmeter shows rated voltage.
11. If voltage is unstable, adjust the **AVR [STAB]** stability control.
12. Re-adjust the **AVR [VOLTS]** control, as needed.

3.3 Adjust the AVR [VOLTS] Voltage Control

NOTICE

Do not exceed the designed safe operating voltage, shown on the alternator rating plate.

NOTICE

Hand trimmer terminals may be above earth potential. Do not ground any of the hand trimmer terminals. Grounding hand trimmer terminals could cause equipment damage.

To set the output voltage AVR [VOLTS] control on the AVR:

1. Check the alternator nameplate to confirm the designed safe operating voltage.
2. Set the **AVR [VOLTS]** control to 0%, the fully counter-clockwise position.

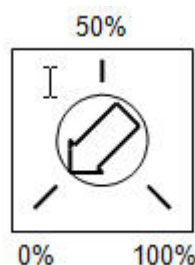

3. Check that the remote hand trimmer is fitted or terminals 1 and 2 are linked.

NOTICE

If a remote hand trimmer is connected, set it to 50%, the midway position.

4. Turn the **AVR [STAB]** control to 50%, the midway position.
5. Start the alternator and set at the correct operating speed.
6. If the red Light Emitting Diode (LED) is illuminated, refer to the Under Frequency Roll Off **AVR [UFRO]** adjustment.
7. Adjust the **AVR [VOLTS]** control slowly clockwise to increase the output voltage.

NOTICE

If the voltage is unstable set the AVR stability before proceeding [Section 3.4 on page 8](#).

8. Adjust the output voltage to the desired nominal value (VAC).
9. If instability is present at rated voltage, refer to the **AVR [STAB]** adjustment, then adjust **AVR [VOLTS]** again, if necessary.
10. If a remote hand trimmer is connected, check its operation.

NOTICE

0% to 100% rotation corresponds to 90% to 110% VAC

The **AVR [VOLTS]** control is now set.

3.4 Adjust the AVR [STAB] Stability Control

1. Check the nameplate to confirm the power rating of the alternator.
2. Check that the jumper link or rotary switch selection (depending on AVR type) matches the alternator power rating for optimal stability response.
3. Set the **AVR [STAB]** control to approximately 75% position.

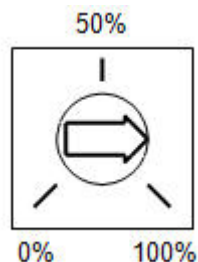

4. Start the alternator and set at the correct operating speed.
5. Verify that the alternator voltage is within safe limits.

NOTICE

If the voltage is unstable go immediately to step 5.

6. Adjust the **AVR [STAB]** control slowly counter-clockwise until the output voltage becomes unstable.
7. Adjust the **AVR [STAB]** control slowly clockwise until the voltage is stable.
8. Adjust the **AVR [STAB]** control a further 5% clockwise.

NOTICE

Readjust the voltage level if necessary (see [Section 3.3 on page 7](#)).

The **AVR [STAB]** control is now set.

3.5 Adjust the AVR [UFRO] Under-Frequency Roll-Off Control

Below an adjustable frequency threshold ('knee' point), the AVR under-speed protection operates to reduce ('roll-off') the excitation voltage in proportion to alternator frequency. The AVR LED lights when UFRO operates.

1. Check the nameplate to confirm the frequency of the alternator.
2. Check that the jumper link or rotary switch selection (depending on AVR type) matches the alternator frequency.
3. Set the **AVR [UFRO]** control to 100%, the fully clockwise position.

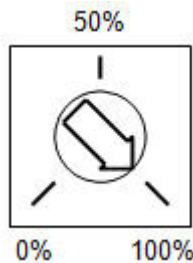

4. Start the alternator and set at the correct operating speed.
5. Verify that the alternator voltage is correct and stable.

NOTICE

If the voltage is high / low / unstable, use method [Section 3.3 on page 7](#) or [Section 3.4 on page 8](#) before proceeding.

6. Reduce the alternator speed to approximately 95% of correct operating speed. i.e. 47.5 Hz for 50 Hz operation, 57.0 Hz for 60 Hz operation.
7. Adjust the **AVR [UFRO]** control slowly counter-clockwise until the AVR LED lights.



8. Adjust the **AVR [UFRO]** control slowly clockwise until the AVR LED is just OFF.



NOTICE

Do not go past the point at which the LED is just OFF.

9. Adjust the alternator speed back to 100% nominal. The LED should be off.



-

The **AVR [UFRO]** control is now set.

4 Accessories

4.1 Alternator Protection Module



4.1.2 Description

The STAMFORD Alternator Protection Module (APM) is a three-phase over-voltage/under-voltage detector. The APM detects if any phase-to-neutral voltage exceeds an adjustable upper threshold or falls below a fixed lower threshold, and switches an internal relay if the fault persists for more than a few cycles (to avoid nuisance activation).

The changeover contact of the relay can be wired to a protective circuit to open a main circuit breaker, remove alternator excitation or stop the engine, for example. The APM is an inexpensive alternative to current monitoring short circuit protection, which requires three or more current transformers.

The APM operates for these faults:

- phase-to-neutral, by detecting under-voltage on the affected phase
- line-to-line, by detecting under-voltage on the affected phases or over-voltage on the third
- three-phase short circuit, by detecting under-voltage (separate no-voltage protection may also be triggered).

Key features include:

- Robust and reliable solid-state electronics
- Built-in relay to operate a protective circuit
- Short circuit protection without current transformers
- Simple connection to the alternator.

4.1.3 Specification

- **Input**
 - Voltage: 100 VAC to 360 VAC, 50 Hz to 60 Hz, 1 phase or 3 phase + neutral (APM 220 VAC version)
 - Voltage: 175 VAC to 625 VAC, 50 Hz to 60 Hz, 3 phase + neutral (APM 380 VAC version)
- **Output**
 - Single pole changeover relay rating: 5 A @ 30 VDC, 5 A @ 240 VAC
 - Power dissipation: 6 W maximum
 - Pulse⁷ length: 200 ms minimum
 - Pulse frequency: 3.2 s typical
- **Preset Range**
 - Under-voltage threshold: 110 VAC ± 10% (APM 220 VAC version)
 - Under-voltage threshold: 190 VAC ± 10% (APM 380 VAC version)
 - Over-voltage threshold: 245 VAC to 360 VAC, adjustable (APM 220 VAC version)
 - Over-voltage threshold: 420 VAC to 625 VAC, adjustable (APM 380 VAC version)
- **Environmental**
 - Vibration: 30 mm/s @ 20 Hz to 100 Hz, 2 g @ 100 Hz to 2 kHz
 - Relative humidity: 95%⁸
 - Storage temperature: -55 °C to +80 °C
 - Operating temperature: -40 °C to +70 °C.

4.1.4 Controls

|  DANGER |
|---|
| <p>Live Electrical Conductors Live electrical conductors can cause serious injury or death by electric shock and burns. To prevent injury and before removing covers over electrical conductors, isolate the generator set from all energy sources, remove stored energy and use lock out/tag out safety procedures.</p> |

|  DANGER |
|--|
| <p>Live Electrical Conductors Live electrical conductors at output, AVR and AVR accessory terminals, and AVR heat sink can cause serious injury or death by electric shock and burns. To prevent injury, take suitable precautions to prevent contact with live conductors including personal protective equipment, insulation, barriers and insulated tools.</p> |

⁷ Pulsed output prevents overloading

⁸ Non-condensing

NOTICE

Refer to alternator wiring diagram for connection details. Mount the APM on a switchboard or bedplate, not in the alternator terminal box.

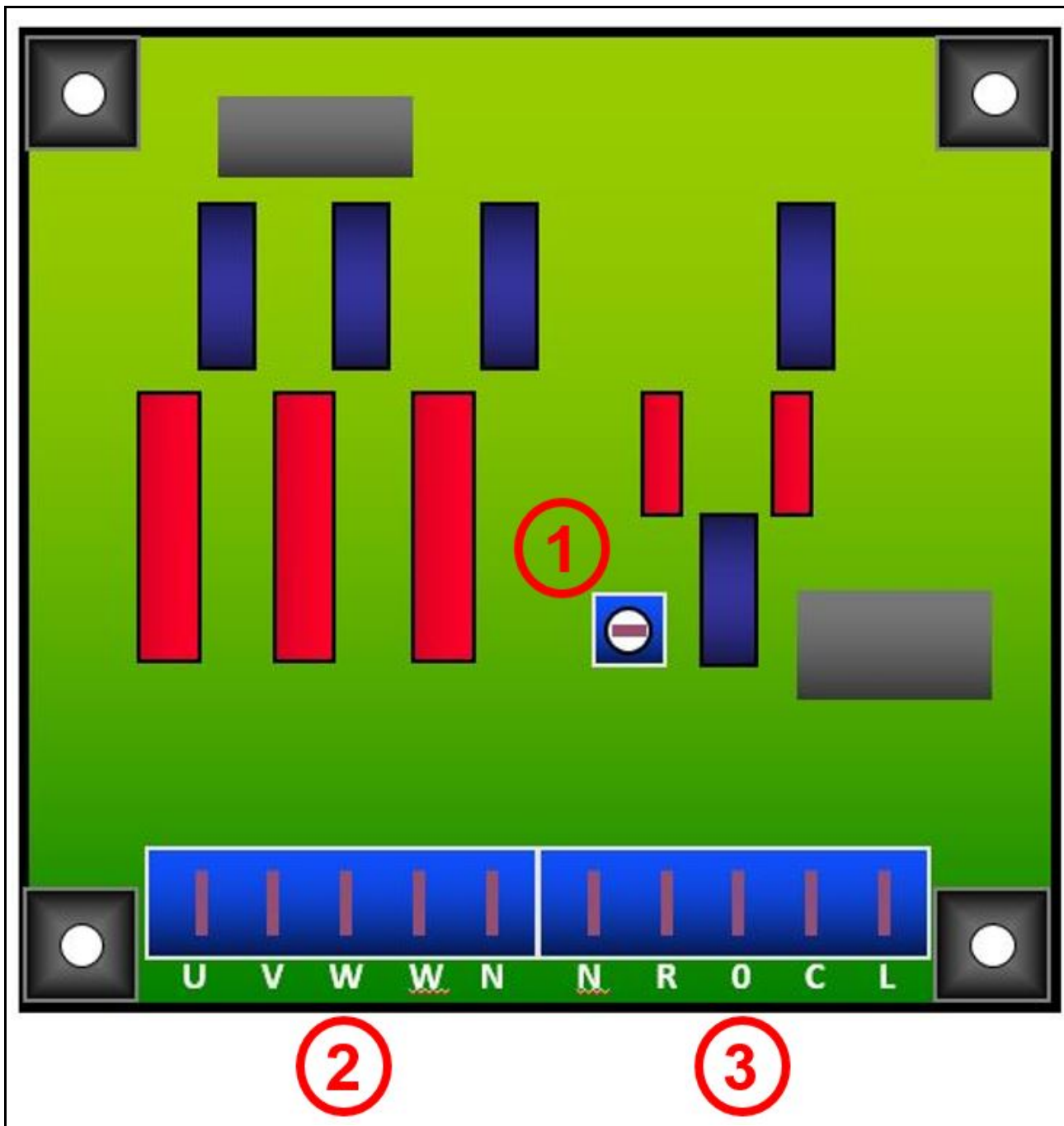

| Ref. | Control | Function | Turn potentiometer CLOCKWISE to |
|------|---|------------------------------------|------------------------------------|
| 1 | THRESHOLD | Adjust over-voltage threshold | increase voltage to operate relay |
| 2 | Sensing Input U, V, W, N | Connect to alternator output | N/A |
| 3 | Output relay contacts L, W : : | Connect to external control system | N/A |

FIGURE 2. ALTERNATOR PROTECTION MODULE CONTROLS

4.2 Diode Failure Detector

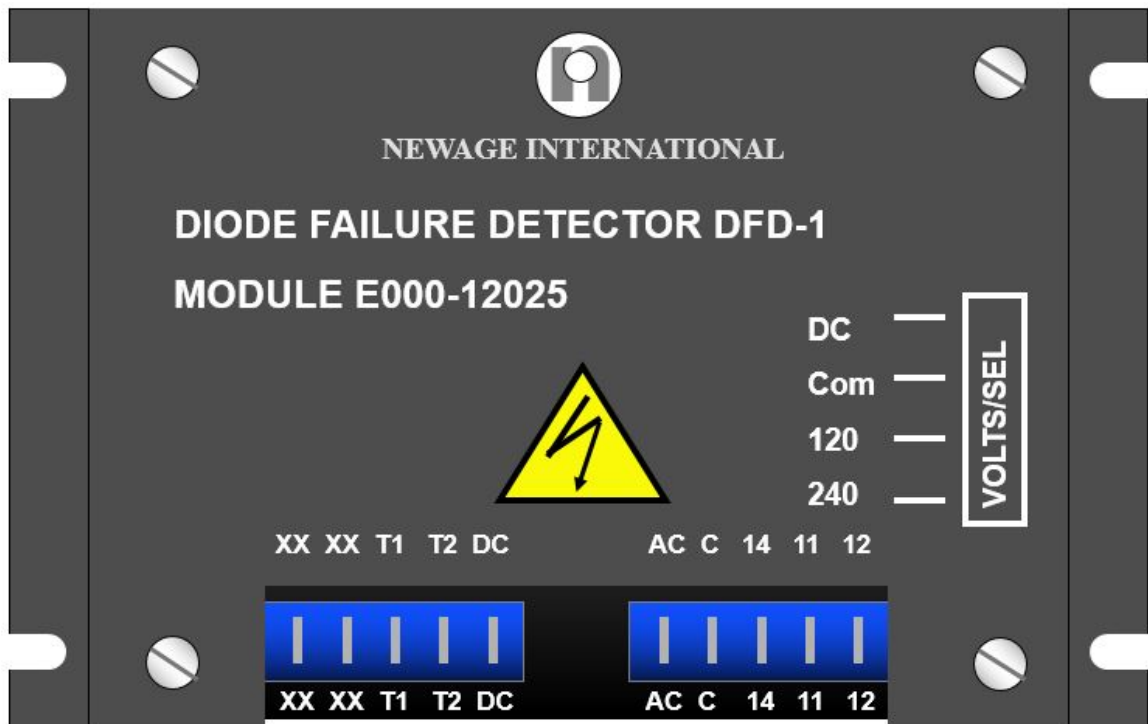

4.2.2 Description

The STAMFORD Diode Failure Detector (DFD) senses ripple current in the exciter output caused by diode failure in short or open circuit, and switches an internal relay if it persists for 7 seconds.

The changeover contacts of the relay can be wired to provide a warning indication of diode failure or initiate an automatic shutdown.

Where the DFD triggers a warning, monitor the exciter field current or voltage and reduce load as necessary, so that the generator set can continue to run until a planned controlled shutdown to replace the diode.

Key features include:

- Robust and reliable solid-state electronics
- Built-in test function
- Selectable power supply
- Simple connection to the alternator.

4.2.3 Specification

- **Sensing Input**
 - Voltage: 0 VDC to 150 VDC
 - Input resistance: 100 k Ω
 - Sensitivity: 50 V peak
- **Power Supply**
 - Voltage: 12 VDC to 28 VDC
 - Voltage: 100 VAC to 140 VAC

-
- Voltage: 200 VAC to 280 VAC
 - Current: 0.2 A maximum
 - **Output**
 - Single pole changeover relay rating: 5 A @ 30 VDC, 5 A @ 240 VAC
 - Isolation: 2 kV
 - Volt-free contacts
 - **Time Delays**
 - Response time: 7 s (approximately)
 - **Environmental**
 - Vibration: 30 mm/s @ 20 Hz to 100 Hz, 2 g @ 100 Hz to 2 kHz
 - Relative humidity: 95%⁹
 - Storage temperature: -55 °C to +80 °C
 - Operating temperature: -40 °C to +70 °C.

4.2.4 Controls

DANGER

Live Electrical Conductors

Live electrical conductors can cause serious injury or death by electric shock and burns. To prevent injury and before removing covers over electrical conductors, isolate the generator set from all energy sources, remove stored energy and use lock out/tag out safety procedures.

DANGER

Live Electrical Conductors

Live electrical conductors at output, AVR and AVR accessory terminals, and AVR heat sink can cause serious injury or death by electric shock and burns. To prevent injury, take suitable precautions to prevent contact with live conductors including personal protective equipment, insulation, barriers and insulated tools.

NOTICE

Refer to alternator wiring diagram for connection details. Mount the DFD on a switchboard or bedplate, not in the alternator terminal box.

⁹ Non-condensing

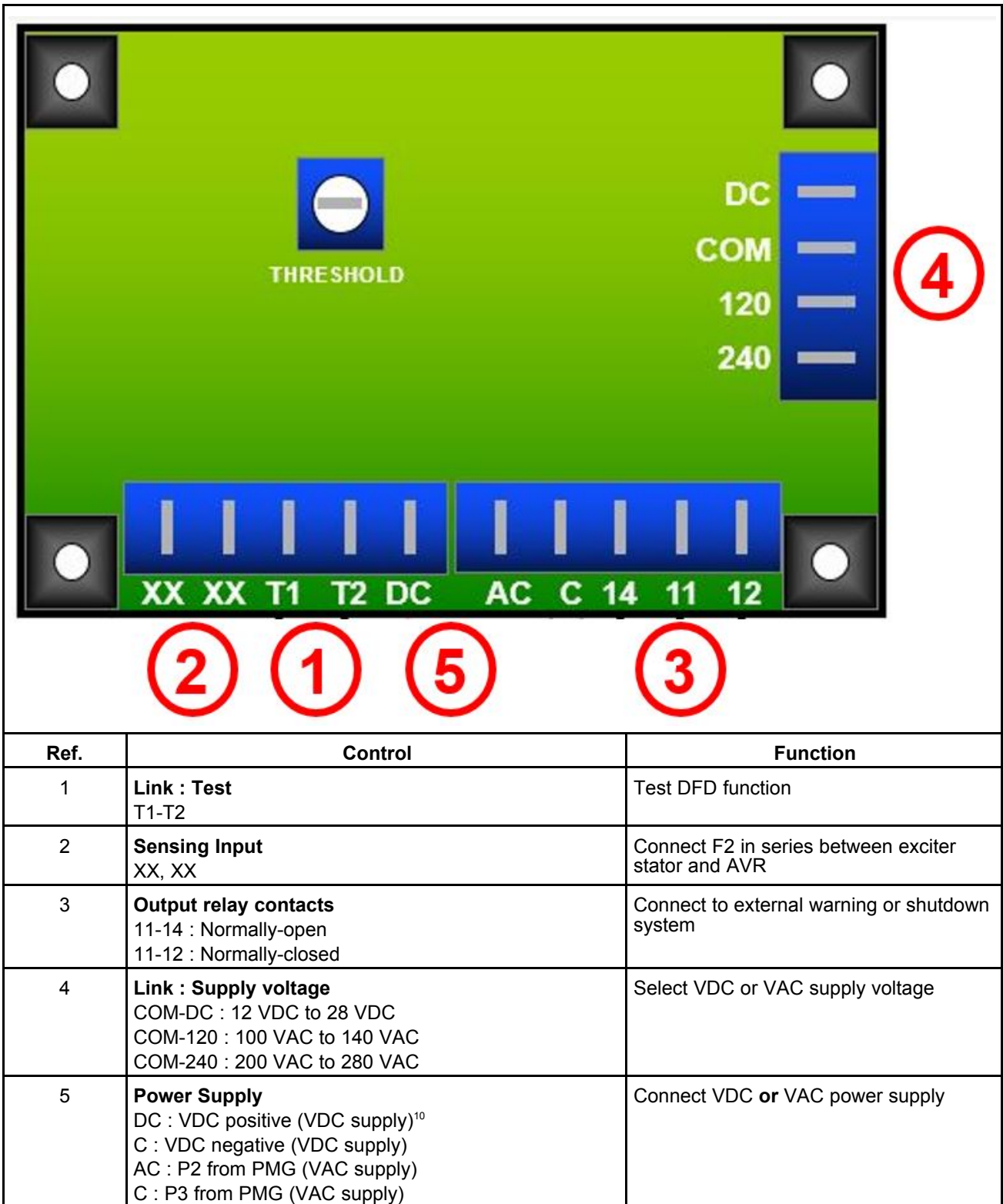

FIGURE 3. DIODE FAILURE DETECTOR CONTROLS

¹⁰ disconnect to reset DFD

4.3 Hand Trimmer (for remote voltage adjustment)

A hand trimmer can be fitted in a convenient position (typically in the generator set control panel) and connected to the AVR to provide fine adjustment of the alternator voltage. The hand trimmer value and the adjustment range obtained is as defined in the Technical Specification. Refer to wiring diagram before removing the shorting link and connecting the hand trimmer.



www.stamford-avk.com

Copyright 2015, Cummins Generator Technologies Ltd. All Rights Reserved
Cummins and the Cummins logo are registered trademarks of Cummins Inc.