

## S7L1M-E4 Wdg.312 - Technical Data Sheet

### Standards

STAMFORD industrial alternators meet the requirements of the relevant parts of the IEC EN 60034 and the relevant section of other international standards such as BS5000, VDE 0530, NEMA MG1-32, IEC34, CSA C22.2-100 and AS1359. Other standards and certifications can be considered on request.

### Quality Assurance

Alternators are manufactured using production procedures having a quality assurance level to BS EN ISO 9001.

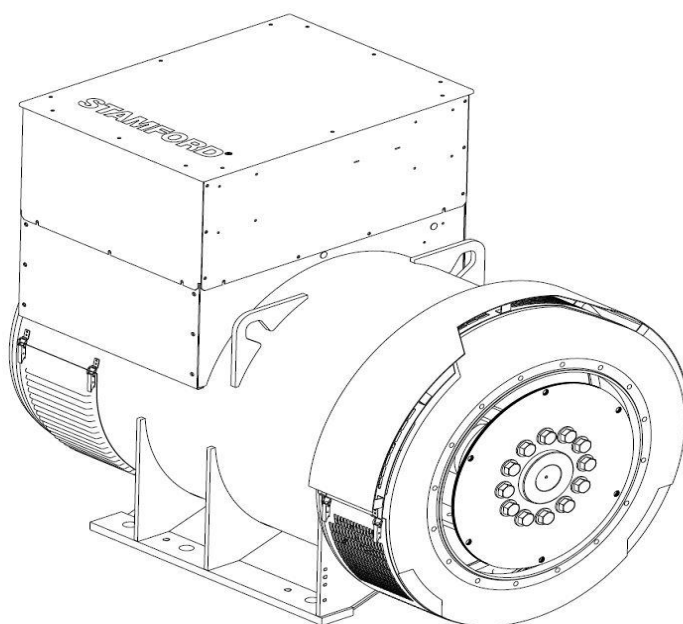

### Excitation and Voltage Regulators

Excitation System					
AVR Type	MX322	DECS100	DECS150		
Voltage Regulation	± 0.5%	± 0.25%	± 0.25%		with 4% Engine Governing
AVR Power	PMG	PMG	PMG		

No Load Excitation Voltage (V)	15.4 - 14.7
No Load Excitation Current (A)	0.68 - 0.64
Full Load Excitation Voltage (V)	58
Full Load Excitation Current (A)	2.6
Exciter Time Constant (seconds)	0.125

# STAMFORD®

## S7L1M-E4 Wdg.312

Electrical Data								
Insulation System	H							
Stator Winding	Double Layer Concentric							
Winding Pitch	2/3							
Winding Leads	6							
Winding Number	312							
Number of Poles	4							
IP Rating	IP23							
RFI Suppression	BS EN 61000-6-2 & BS EN 61000-6-4, VDE 0875G, VDE 0875N. Refer to factory for others							
Waveform Distortion	NO LOAD < 1.5% NON-DISTORTING BALANCED LINEAR LOAD < 5.0%							
Short Circuit Ratio	1/Xd							
Steady State X/R Ratio	22.84							
50 Hz					60 Hz			
Telephone Interference	THF<2%				TIF<50			
Cooling Air Flow	2.52 m³/sec				3.02 m³/sec			
Voltage Star (V)	380	400	415	440	416	440	460	480
Voltage Parallel Star (V)	-	-	-	-	-	-	-	-
Voltage Delta (V)	-	-	-	-	-	-	-	-
kVA Base Rating (Class H) for Reactance Values (kVA)	1500	1540	1540	1515	1625	1712	1787	1875
Saturated Values in Per Unit at Base Ratings and Voltages								
Xd Dir. Axis Synchronous	2.21	2.05	1.90	1.67	2.40	2.26	2.16	2.08
X'd Dir. Axis Transient	0.17	0.16	0.15	0.13	0.19	0.17	0.17	0.16
X''d Dir. Axis Subtransient	0.12	0.11	0.10	0.09	0.13	0.12	0.12	0.11
Xq Quad. Axis Reactance	1.64	1.52	1.42	1.24	1.78	1.68	1.60	1.55
X''q Quad. Axis Subtransient	0.19	0.18	0.16	0.14	0.21	0.19	0.19	0.18
XL Stator Leakage Reactance	0.07	0.07	0.06	0.05	0.08	0.07	0.07	0.07
X2 Negative Sequence Reactance	0.15	0.14	0.13	0.11	0.16	0.16	0.15	0.14
X0 Zero Sequence Reactance	0.03	0.03	0.02	0.02	0.03	0.03	0.03	0.03
Unsaturated Values in Per Unit at Base Ratings and Voltages								
Xd Dir. Axis Synchronous	2.66	2.46	2.29	2.00	2.88	2.71	2.59	2.50
X'd Dir. Axis Transient	0.20	0.18	0.17	0.15	0.21	0.20	0.19	0.18
X''d Dir. Axis Subtransient	0.14	0.13	0.12	0.11	0.15	0.14	0.14	0.13
Xq Quad. Axis Reactance	1.69	1.57	1.46	1.28	1.84	1.73	1.65	1.59
X''q Quad. Axis Subtransient	0.23	0.21	0.20	0.17	0.25	0.23	0.22	0.21
XL Stator Leakage Reactance	0.08	0.07	0.07	0.06	0.09	0.08	0.08	0.07
Xlr Rotor Leakage Reactance	0.17	0.16	0.15	0.13	0.19	0.18	0.17	0.16
X2 Negative Sequence Reactance	0.18	0.17	0.16	0.14	0.20	0.19	0.18	0.17
X0 Zero Sequence Reactance	0.03	0.03	0.03	0.03	0.04	0.03	0.03	0.03

# STAMFORD

## S7L1M-E4 Wdg.312

<b>Time Constants (Seconds)</b>		
T'd Transient Time Const.	0.150	
T''d Sub-Transient Time Const.	0.017	
T'do O.C. Field Time Const.	4.290	
Ta Armature Time Const.	0.028	
T''q Sub-Transient Time Const.	0.0100	
<b>Resistances in Ohms (<math>\Omega</math>) at 22°C</b>		
Stator Winding Resistance (Ra), per phase for series connected	0.0009	
Rotor Winding Resistance (Rf)	1.95	
Exciter Stator Winding Resistance	22.3	
Exciter Rotor Winding Resistance per phase	0.065	
PMG Phase Resistance (Rpmg) per phase	1.91	
Positive Sequence Resistance (R1)	0.0011	
Negative Sequence Resistance (R2)	0.0012	
Zero Sequence Resistance (R0)	0.0011	
<b>Saturation Factors</b>	<b>400V</b>	<b>480V</b>
SG1.0	0.281	0.304
SG1.2	1.308	1.184
<b>Mechanical Data</b>		
Shaft and Keys	All alternator rotors are dynamically balanced to better than BS6861: Part 1 Grade 2.5 for minimum vibration in operation. Two bearing generators are balanced with a half key.	
	1 Bearing	2 Bearing
SAE Adaptor	SAE0 , 00	SAE0 , 00
Moment of Inertia	40.98 kgm <sup>2</sup>	40.08 kgm <sup>2</sup>
Weight Wound Stator	1518kg	1518kg
Weight Wound Rotor	1353kg	1300kg
Weight Complete Alternator	3350kg	3264kg
Shipping weight in a Crate	3399kg	3313kg
Packing Crate Size	200 X 105 X 155(cm)	200 X 105 X155(cm)
Maximum Over Speed	2250 RPM for two minutes	
Bearing Drive End	-	BALL. 6228
Bearing Non-Drive End	BALL. 6319	BALL. 6319

# STAMFORD®

## S7L1M-E4 Wdg.312

### THREE PHASE EFFICIENCY CURVES

50Hz

60Hz

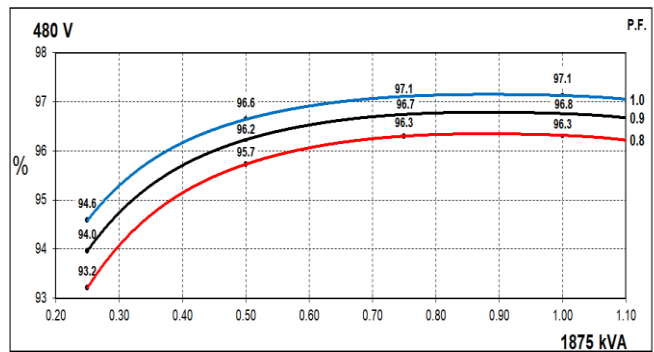
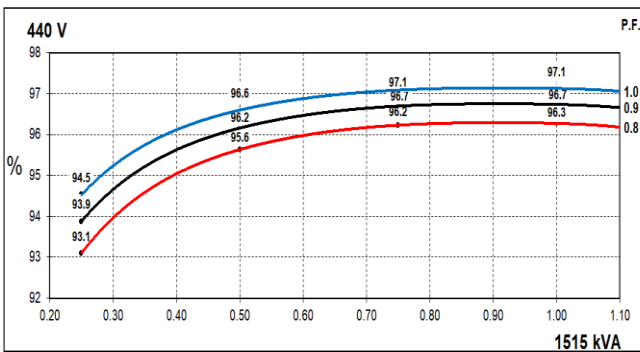
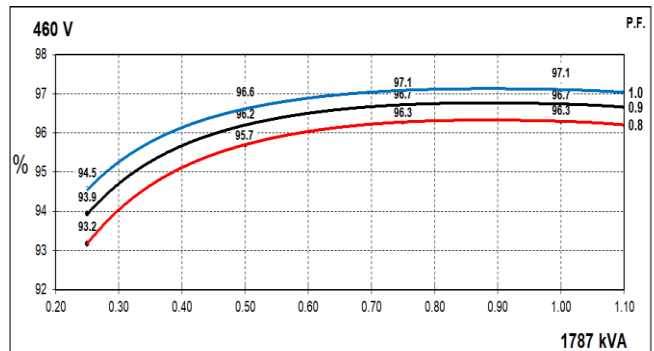
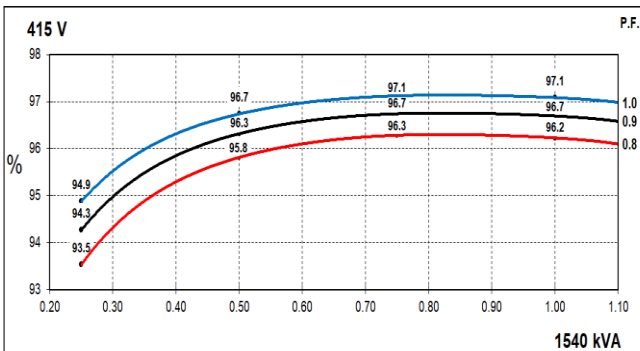
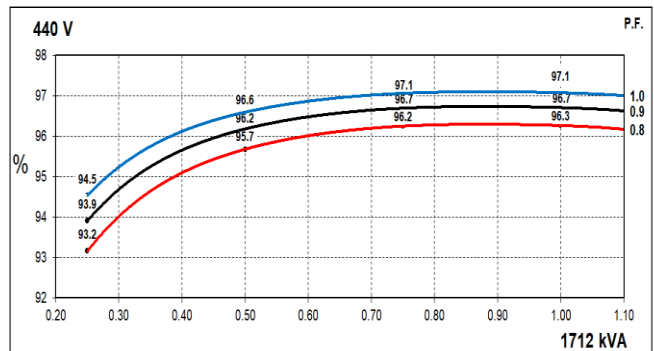
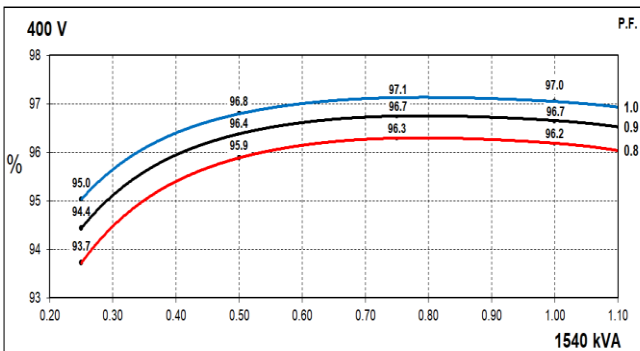
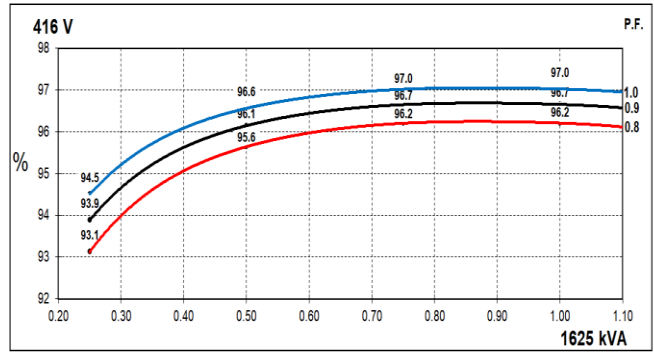
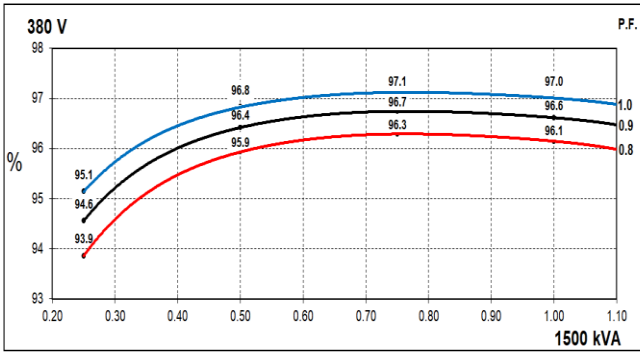

# STAMFORD

S7L1M-E4 Wdg.312

## Locked Rotor Motor Starting Curves - Separately Excited

**50Hz**

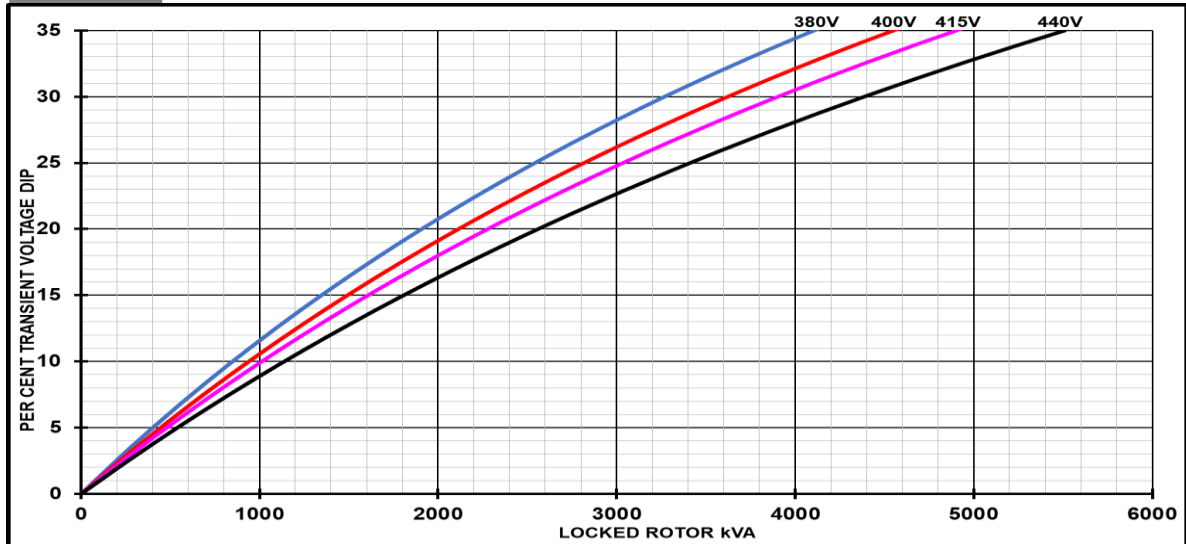

**60Hz**

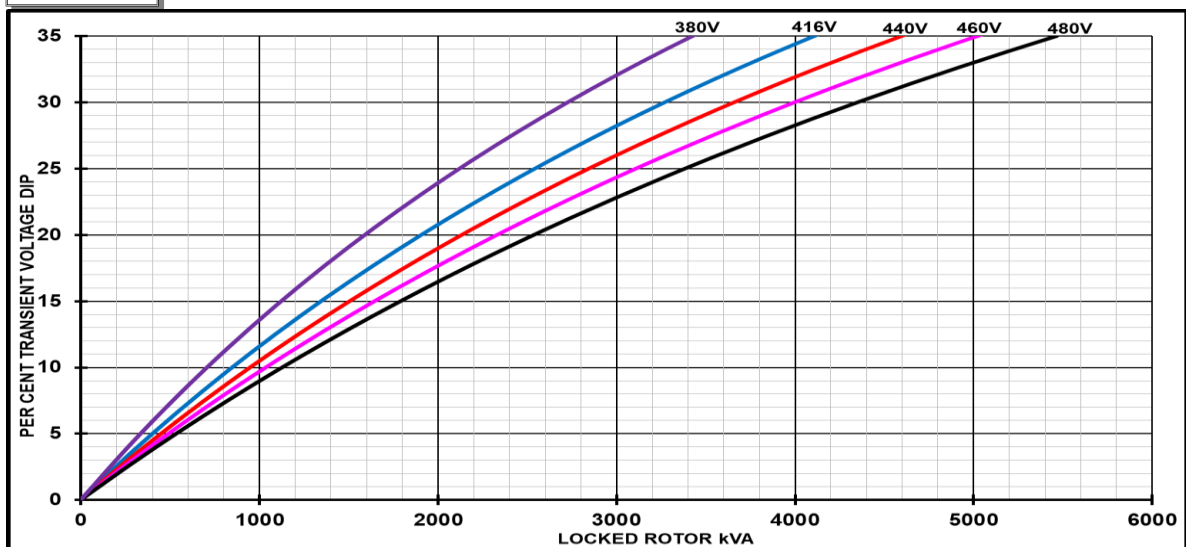

Transient Voltage Dip Scaling Factor		Transient Voltage Rise Scaling Factor	
Lagging PF	Scaling Factor	Lagging PF	Scaling Factor
<= 0.4	1.00	<= 0.4	1.25
0.5	0.95	0.5	1.20
0.6	0.90	0.6	1.15
0.7	0.86	0.7	1.10
0.8	0.83	> 0.7	1.00
0.9	0.75		
0.95	0.70		
1	0.65		

Note: To determine % Transient Voltage Dip or Voltage Rise at various PF, multiply the % Voltage Dip from the curve directly by the Scaling Factor.

# STAMFORD<sup>®</sup>

## S7L1M-E4 Wdg.312

### Three-phase Short Circuit Decrement Curve - Separately Excited

**50Hz**

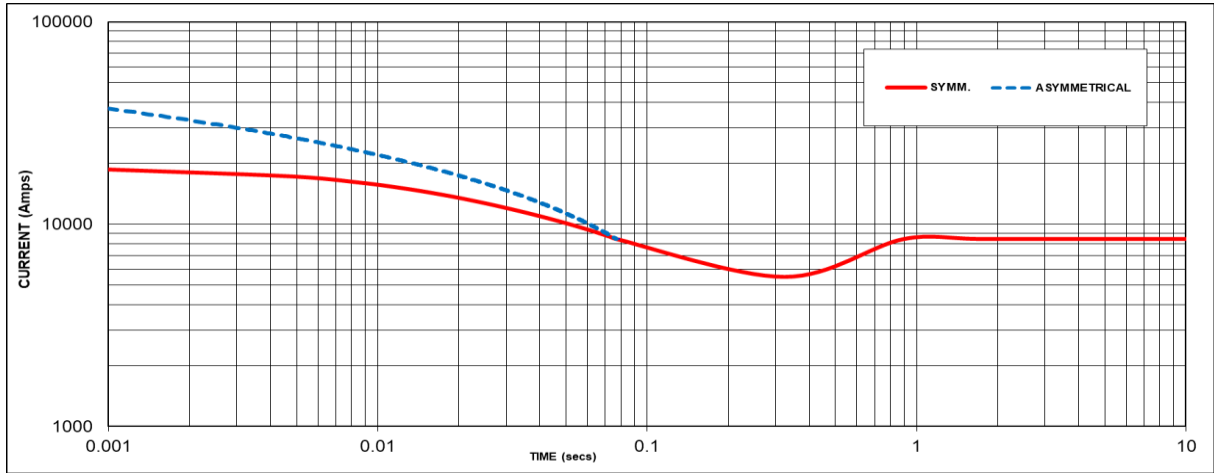

Sustained Short Circuit = 8455 Amps

**60Hz**

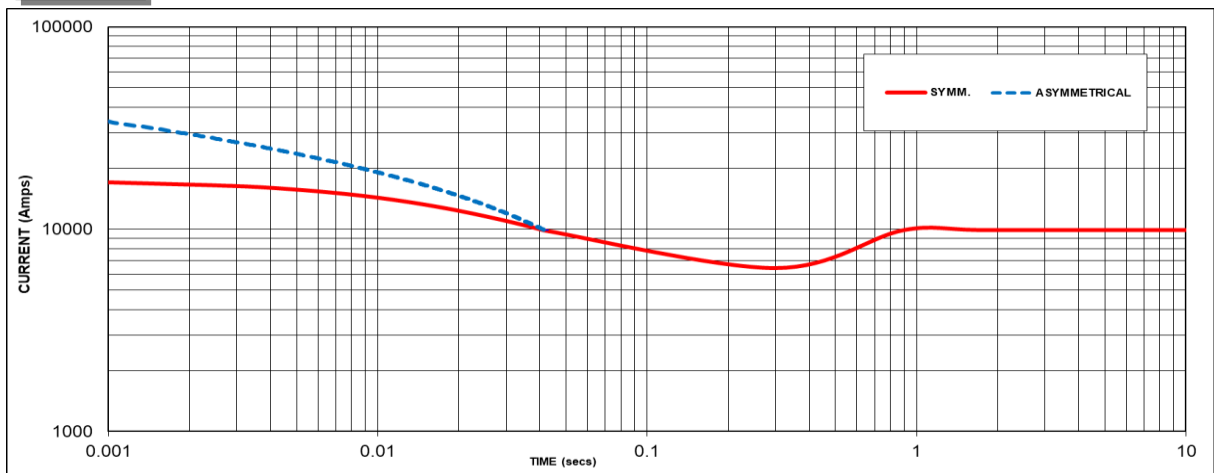

Sustained Short Circuit = 9895 Amps

**Note 1**

The following multiplication factors should be used to adjust the values from curve between time 0.001 seconds and the minimum current point in respect of nominal operating voltage :

50Hz		60Hz	
Voltage	Factor	Voltage	Factor
380V	X 1.00	416V	X 1.00
400V	X 1.05	440V	X 1.06
415V	X 1.09	460V	X 1.10
440V	X 1.16	480V	X 1.15

The sustained current value is constant irrespective of voltage level

**Note 2**

The following multiplication factor should be used to convert the values calculated in accordance with NOTE 1 to those applicable to the various types of short circuit :

	3-phase	2-phase L-L	1-phase L-N
Instantaneous	x 1.00	x 0.87	x 1.30
Minimum	x 1.00	x 1.80	x 3.20
Sustained	x 1.00	x 1.50	x 2.50
Max. sustained duration	10 sec.	5 sec.	2 sec.

**Note 3**

All other times are unchanged  
 Curves are drawn for Star connections under no-load excitation at rated speeds. For other connection (where applicable) the following multipliers should be applied to current values as shown :  
 Parallel Star = Curve current value X 2  
 Series Delta = Curve current value X 1.732

# STAMFORD®

S7L1M-E4 Wdg.312

## Typical Alternator Operating Charts

**400V/50Hz**

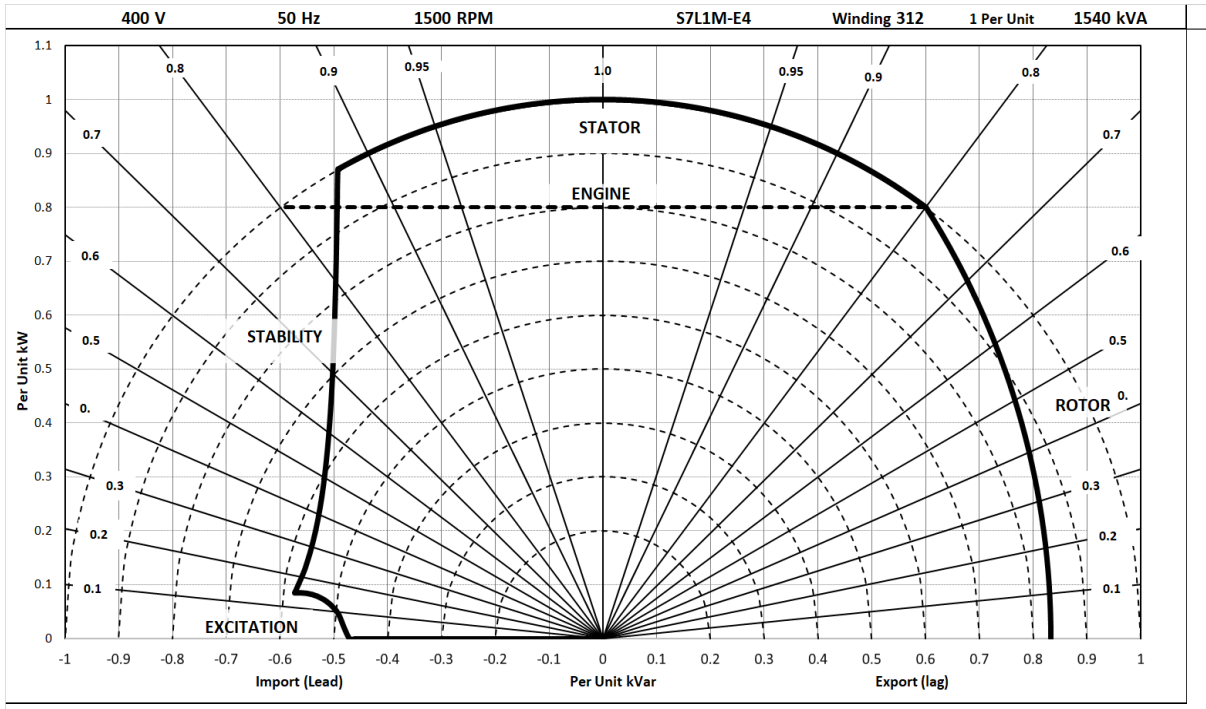

**480V/60Hz**

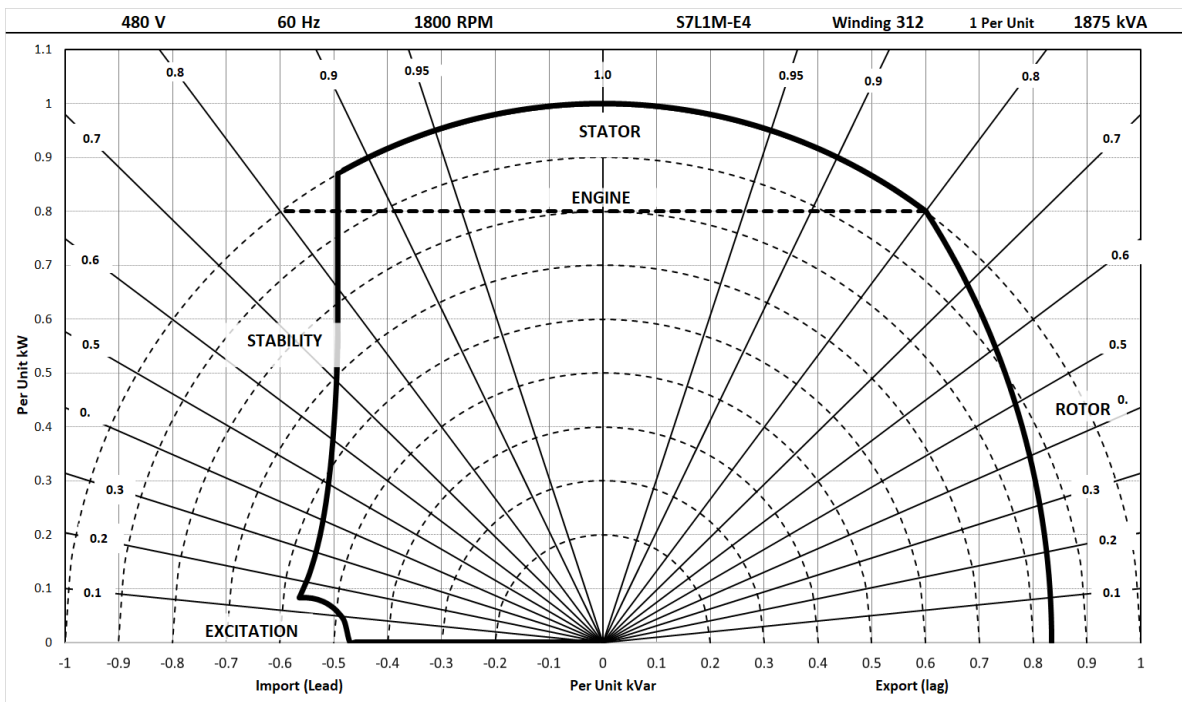

# STAMFORD®

## S7L1M-E4 Wdg.312

### RATINGS AT 0.8 POWER FACTOR

Class - Temp Rise		Standby				Cont. H - 110/50°C				Cont. F - 90/50°C				Cont. B - 70/50°C			
<b>50 Hz</b>	Star (V)	380	400	415	440	380	400	415	440	380	400	415	440	380	400	415	440
	Parallel Star (V)	N/A	N/A	N/A	N/A	N/A	N/A	N/A	N/A	N/A	N/A	N/A	N/A	N/A	N/A	N/A	N/A
	Delta (V)	N/A	N/A	N/A	N/A	N/A	N/A	N/A	N/A	N/A	N/A	N/A	N/A	N/A	N/A	N/A	N/A
	kVA	N/A	N/A	N/A	N/A	1500	1540	1540	1515	1320	1370	1370	1360	1240	1280	1280	1255
	kW	N/A	N/A	N/A	N/A	1200	1232	1232	1212	1056	1096	1096	1088	992	1024	1024	1004
	Efficiency (%)	N/A	N/A	N/A	N/A	96.1	96.2	96.2	96.3	96.3	96.3	96.3	96.3	96.3	96.3	96.3	96.3
	kW Input	N/A	N/A	N/A	N/A	1248	1281	1280	1259	1097	1138	1138	1130	1030	1063	1063	1043

<b>60 Hz</b>	Star (V)	416	440	460	480	416	440	460	480	416	440	460	480	416	440	460	480
	Parallel Star (V)	N/A	N/A	N/A	N/A	N/A	N/A	N/A	N/A	N/A	N/A	N/A	N/A	N/A	N/A	N/A	N/A
	Delta (V)	N/A	N/A	N/A	N/A	N/A	N/A	N/A	N/A	N/A	N/A	N/A	N/A	N/A	N/A	N/A	N/A
	kVA	N/A	N/A	N/A	N/A	1625	1712	1787	1875	1550	1650	1725	1790	1370	1450	1525	1575
	kW	N/A	N/A	N/A	N/A	1300	1370	1430	1500	1240	1320	1380	1432	1096	1160	1220	1260
	Efficiency (%)	N/A	N/A	N/A	N/A	96.2	96.3	96.3	96.3	96.2	96.3	96.3	96.3	96.2	96.3	96.3	96.4
	kW Input	N/A	N/A	N/A	N/A	1351	1423	1485	1557	1289	1371	1433	1486	1139	1205	1266	1308

#### De-rates

All values tabulated above are subject to the following reductions:

- 5% when air inlet filters are fitted
- 3% for every 500 meters by which the operating altitude exceeds 1000 meters above mean sea level
- 3% for every 5°C by which the operational ambient temperature exceeds 40°C @ Class H temperature rise (please refer to applications for ambient temperature de-rates at other temperature rise classes)
- For any other operating conditions impacting the cooling circuit please refer to applications

Note: Requirement for operating in an ambient exceeding 60°C and altitude exceeding 4000 meters (for <690V) or 1500 meters (for >690V) must be referred to applications.

#### Dimensional and Torsional Drawing

For dimensional and torsional information please refer to the alternator General Arrangement and rotor drawings available on our website (<http://stamford-avk.com/>)

**Note:** Continuous development of our products means that the information contained in our data sheets can change without notice, and specifications should always be confirmed with Cummins Generator Technologies prior to purchase.





Follow us @stamfordavk



Cummins Generator Technologies



View our videos at [youtube.com/stamfordavk](https://youtube.com/stamfordavk)

**[news.stamford-avk.com](https://news.stamford-avk.com)**

**For Applications Support:**  
**[applications@cummins.com](mailto:applications@cummins.com)**

**For Customer Service:**  
**[emea.service@cummins.com](mailto:emea.service@cummins.com)**

**For General Enquiries:**  
**[Stamford-avk@cummins.com](mailto:Stamford-avk@cummins.com)**

Copyright 2016. Cummins Generator Technologies Ltd. All rights reserved.  
Cummins and the Cummins logo are registered trade marks of Cummins Inc.  
STAMFORD is a registered trade mark of Cummins Generator Technologies Ltd.

