

S7L1M-H4 Wdg.13 - Technical Data Sheet

Standards

STAMFORD industrial alternators meet the requirements of the relevant parts of the IEC EN 60034 and the relevant section of other international standards such as BS5000, VDE 0530, NEMA MG1-32, IEC34, CSA C22.2-100 and AS1359. Other standards and certifications can be considered on request.

Quality Assurance

Alternators are manufactured using production procedures having a quality assurance level to BS EN ISO 9001.

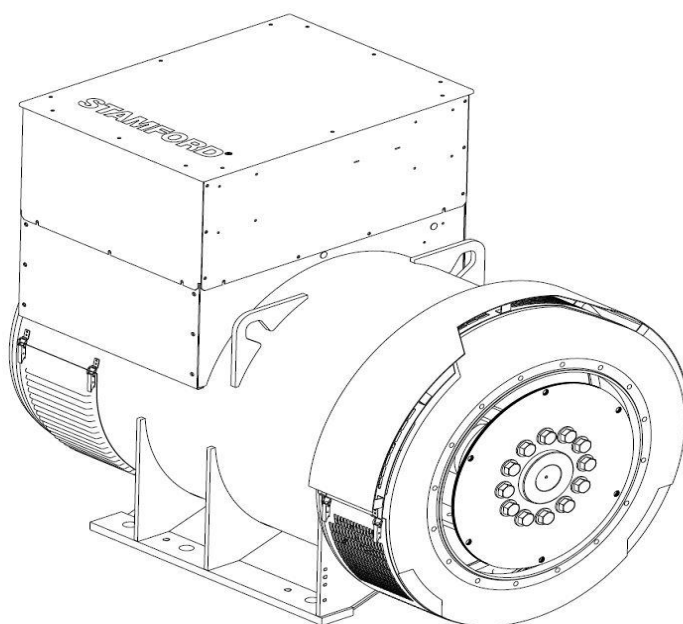

Excitation and Voltage Regulators

| Excitation System | | | | | |
|--------------------|--------|---------|---------|--|--------------------------|
| AVR Type | MX322 | DECS100 | DECS150 | | |
| Voltage Regulation | ± 0.5% | ± 0.25% | ± 0.25% | | with 4% Engine Governing |
| AVR Power | PMG | PMG | PMG | | |

| | |
|----------------------------------|-------|
| No Load Excitation Voltage (V) | 20.46 |
| No Load Excitation Current (A) | 1.02 |
| Full Load Excitation Voltage (V) | 59 |
| Full Load Excitation Current (A) | 2.8 |
| Exciter Time Constant (seconds) | 0.165 |

STAMFORD®

S7L1M-H4 Wdg.13

| Electrical Data | | | | |
|---|---|------|------|---|
| Insulation System | H | | | |
| Stator Winding | Double Layer Concentric | | | |
| Winding Pitch | 2/3 | | | |
| Winding Leads | 6 | | | |
| Winding Number | 13 | | | |
| Number of Poles | 4 | | | |
| IP Rating | IP23 | | | |
| RFI Suppression | BS EN 61000-6-2 & BS EN 61000-6-4, VDE 0875G, VDE 0875N. Refer to factory for others | | | |
| Waveform Distortion | NO LOAD < 1.5% NON-DISTORTING BALANCED LINEAR LOAD < 5.0% | | | |
| Short Circuit Ratio | 1/Xd | | | |
| Steady State X/R Ratio | 31.68 | | | |
| 60 Hz | | | | |
| Telephone Interference | TIF<50 | | | |
| Cooling Air Flow | 2.64 m³/sec | | | |
| Voltage Star (V) | 380 | 400 | 416 | - |
| Voltage Parallel Star (V) | - | - | - | - |
| Voltage Delta (V) | - | - | - | - |
| kVA Base Rating (Class H) for Reactance Values (kVA) | 2300 | 2300 | 2300 | - |
| Saturated Values in Per Unit at Base Ratings and Voltages | | | | |
| Xd Dir. Axis Synchronous | 1.75 | 1.58 | 1.46 | - |
| X'd Dir. Axis Transient | 0.16 | 0.14 | 0.13 | - |
| X''d Dir. Axis Subtransient | 0.11 | 0.10 | 0.10 | - |
| Xq Quad. Axis Reactance | 1.57 | 1.42 | 1.31 | - |
| X''q Quad. Axis Subtransient | 0.16 | 0.15 | 0.13 | - |
| XL Stator Leakage Reactance | 0.06 | 0.05 | 0.05 | - |
| X2 Negative Sequence Reactance | 0.14 | 0.12 | 0.11 | - |
| X0 Zero Sequence Reactance | 0.03 | 0.02 | 0.02 | - |
| Unsaturated Values in Per Unit at Base Ratings and Voltages | | | | |
| Xd Dir. Axis Synchronous | 2.10 | 1.89 | 1.75 | - |
| X'd Dir. Axis Transient | 0.18 | 0.16 | 0.15 | - |
| X''d Dir. Axis Subtransient | 0.13 | 0.12 | 0.11 | - |
| Xq Quad. Axis Reactance | 1.62 | 1.46 | 1.35 | - |
| X''q Quad. Axis Subtransient | 0.19 | 0.17 | 0.16 | - |
| XL Stator Leakage Reactance | 0.07 | 0.06 | 0.05 | - |
| Xlr Rotor Leakage Reactance | 0.16 | 0.15 | 0.14 | - |
| X2 Negative Sequence Reactance | 0.16 | 0.15 | 0.14 | - |
| X0 Zero Sequence Reactance | 0.03 | 0.03 | 0.03 | - |

STAMFORD®

S7L1M-H4 Wdg.13

| Time Constants (Seconds) | | |
|--|---|------------------------|
| T'd Transient Time Const. | 0.147 | |
| T''d Sub-Transient Time Const. | 0.013 | |
| T'do O.C. Field Time Const. | 4.690 | |
| Ta Armature Time Const. | 0.041 | |
| T''q Sub-Transient Time Const. | 0.0107 | |
| Resistances in Ohms (Ω) at 22°C | | |
| Stator Winding Resistance (Ra), per phase for series connected | 0.00039 | |
| Rotor Winding Resistance (Rf) | 2.38 | |
| Exciter Stator Winding Resistance | 20.1 | |
| Exciter Rotor Winding Resistance per phase | 0.057 | |
| PMG Phase Resistance (Rpmg) per phase | 1.91 | |
| Positive Sequence Resistance (R1) | 0.0005 | |
| Negative Sequence Resistance (R2) | 0.0006 | |
| Zero Sequence Resistance (R0) | 0.0005 | |
| Saturation Factors | | 416V |
| SG1.0 | 0.446 | |
| SG1.2 | 3.653 | |
| Mechanical Data | | |
| Shaft and Keys | All alternator rotors are dynamically balanced to better than BS6861: Part 1 Grade 2.5 for minimum vibration in operation. Two bearing generators are balanced with a half key. | |
| | 1 Bearing | 2 Bearing |
| SAE Adaptor | SAE0, 00 | SAE0, 00 |
| Moment of Inertia | 52.23 kgm ² | 51.17 kgm ² |
| Weight Wound Stator | 1980kg | 1980kg |
| Weight Wound Rotor | 1693kg | 1651kg |
| Weight Complete Alternator | 4083kg | 4054kg |
| Shipping weight in a Crate | 4135kg | 4106kg |
| Packing Crate Size | 220 x 105 x 155(cm) | 220 x 105 x 155(cm) |
| Maximum Over Speed | 2250 RPM for two minutes | |
| Bearing Drive End | - | BALL. 6232 |
| Bearing Non-Drive End | BALL. 6319 | BALL. 6319 |

STAMFORD®

S7L1M-H4 Wdg.13

THREE PHASE EFFICIENCY CURVES

60Hz

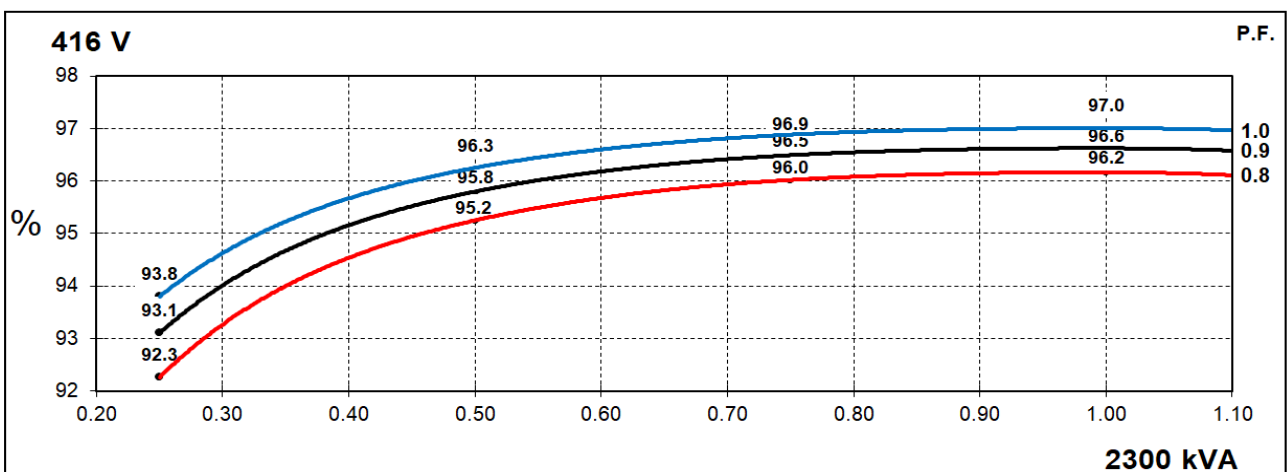
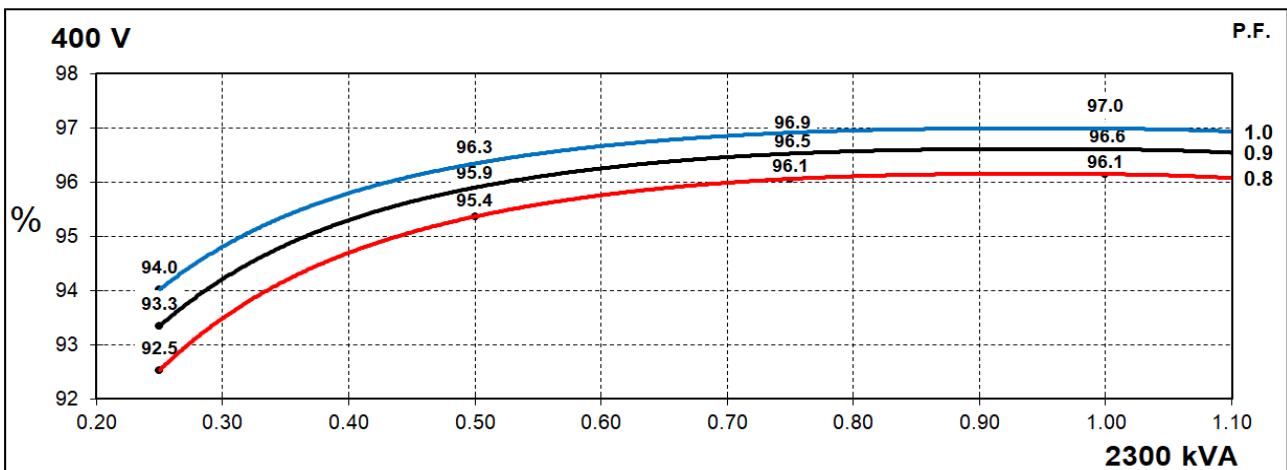
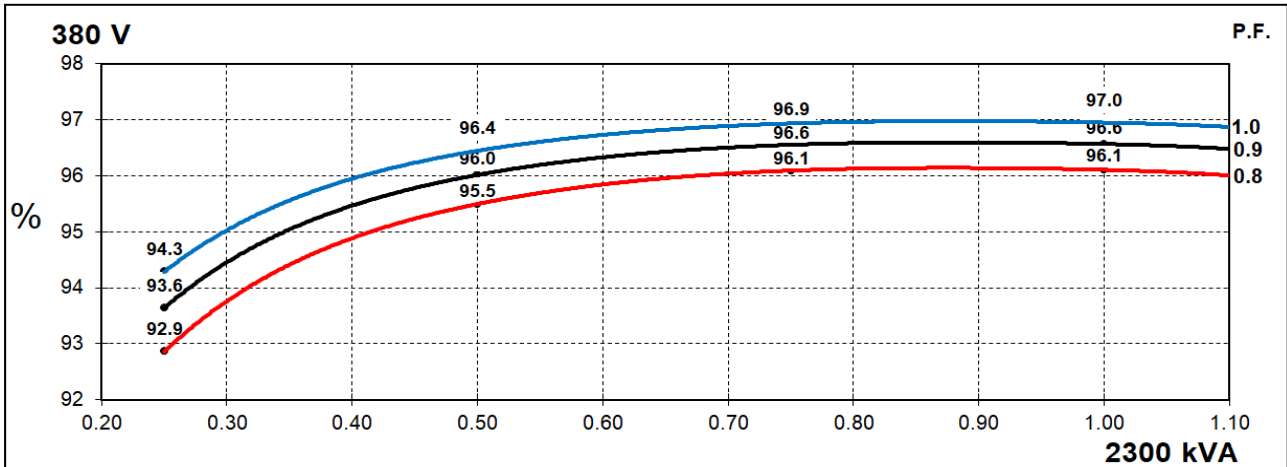

STAMFORD

S7L1M-H4 Wdg.13

Locked Rotor Motor Starting Curves - Separately Excited

60Hz

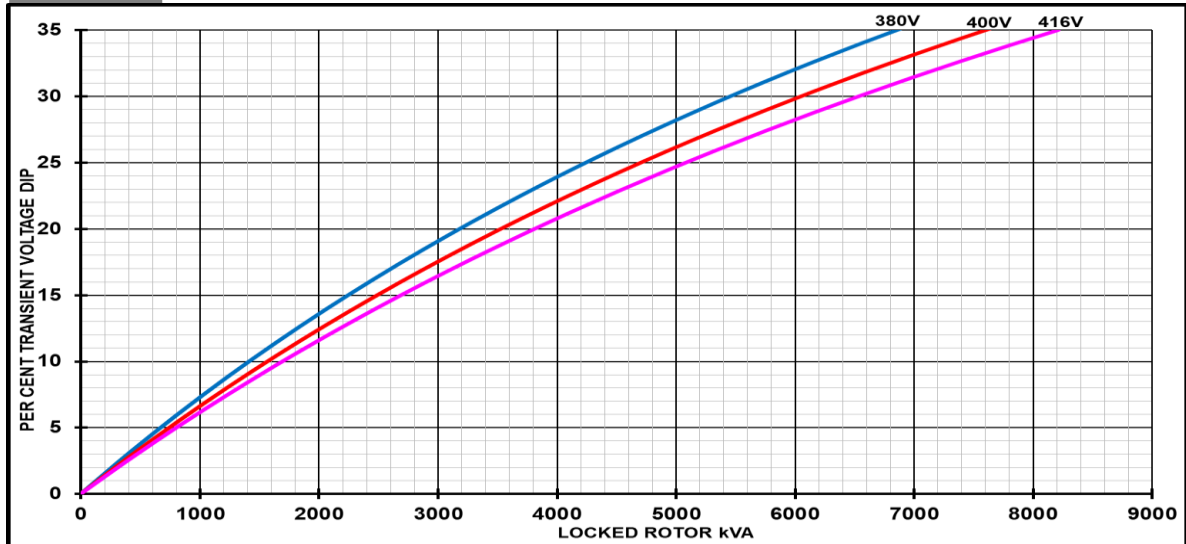

| Transient Voltage Dip Scaling Factor | | Transient Voltage Rise Scaling Factor | |
|--------------------------------------|----------------|---------------------------------------|----------------|
| Lagging PF | Scaling Factor | Lagging PF | Scaling Factor |
| <= 0.4 | 1.00 | <= 0.4 | 1.25 |
| 0.5 | 0.95 | 0.5 | 1.20 |
| 0.6 | 0.90 | 0.6 | 1.15 |
| 0.7 | 0.86 | 0.7 | 1.10 |
| 0.8 | 0.83 | > 0.7 | 1.00 |
| 0.9 | 0.75 | | |
| 0.95 | 0.70 | | |
| 1 | 0.65 | | |

Note: To determine % Transient Voltage Dip or Voltage Rise at various PF, multiply the % Voltage Dip from the curve directly by the Scaling Factor.

STAMFORD®

S7L1M-H4 Wdg.13

Three-phase Short Circuit Decrement Curve - Separately Excited

60Hz

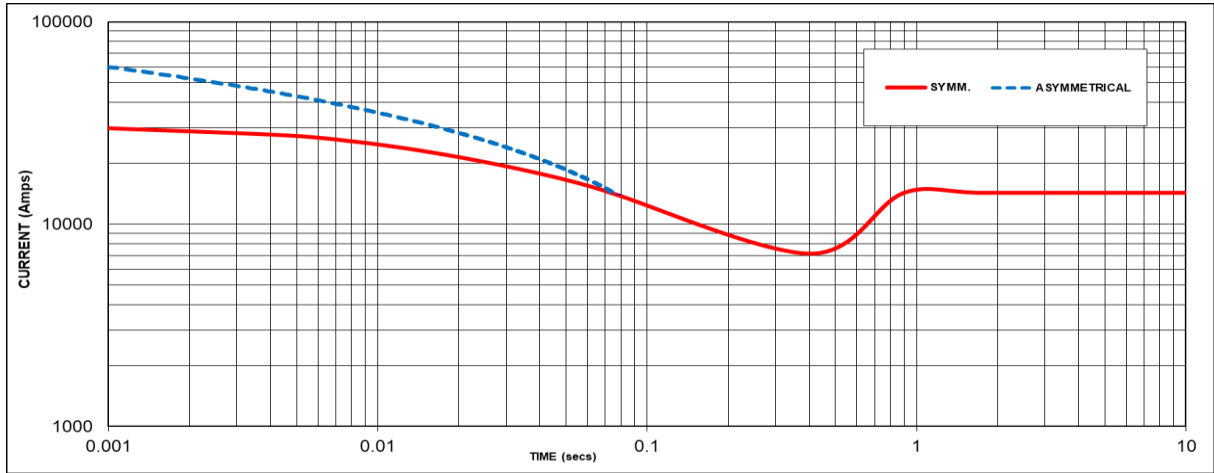

Sustained Short Circuit = 14318 Amps

Note 1

The following multiplication factors should be used to adjust the values from curve between time 0.001 seconds and the minimum current point in respect of nominal operating voltage :

| 50Hz | | 60Hz | |
|---------|--------|---------|--------|
| Voltage | Factor | Voltage | Factor |
| - | - | 380V | x 1.00 |
| - | - | 400V | x 1.05 |
| - | - | 416V | x 1.09 |
| - | - | - | - |

The sustained current value is constant irrespective of voltage level

Note 2

The following multiplication factor should be used to convert the values calculated in accordance with NOTE 1 to those applicable to the various types of short circuit :

| | 3-phase | 2-phase L-L | 1-phase L-N |
|-------------------------|---------|-------------|-------------|
| Instantaneous | x 1.00 | x 0.87 | x 1.30 |
| Minimum | x 1.00 | x 1.80 | x 3.20 |
| Sustained | x 1.00 | x 1.50 | x 2.50 |
| Max. sustained duration | 10 sec. | 5 sec. | 2 sec. |

Note 3

All other times are unchanged
 Curves are drawn for Star connections under no-load excitation at rated speeds. For other connection (where applicable) the following multipliers should be applied to current values as shown :
 Parallel Star = Curve current value X 2
 Series Delta = Curve current value X 1.732

STAMFORD®

S7L1M-H4 Wdg.13

Typical Alternator Operating Charts

416V/60Hz

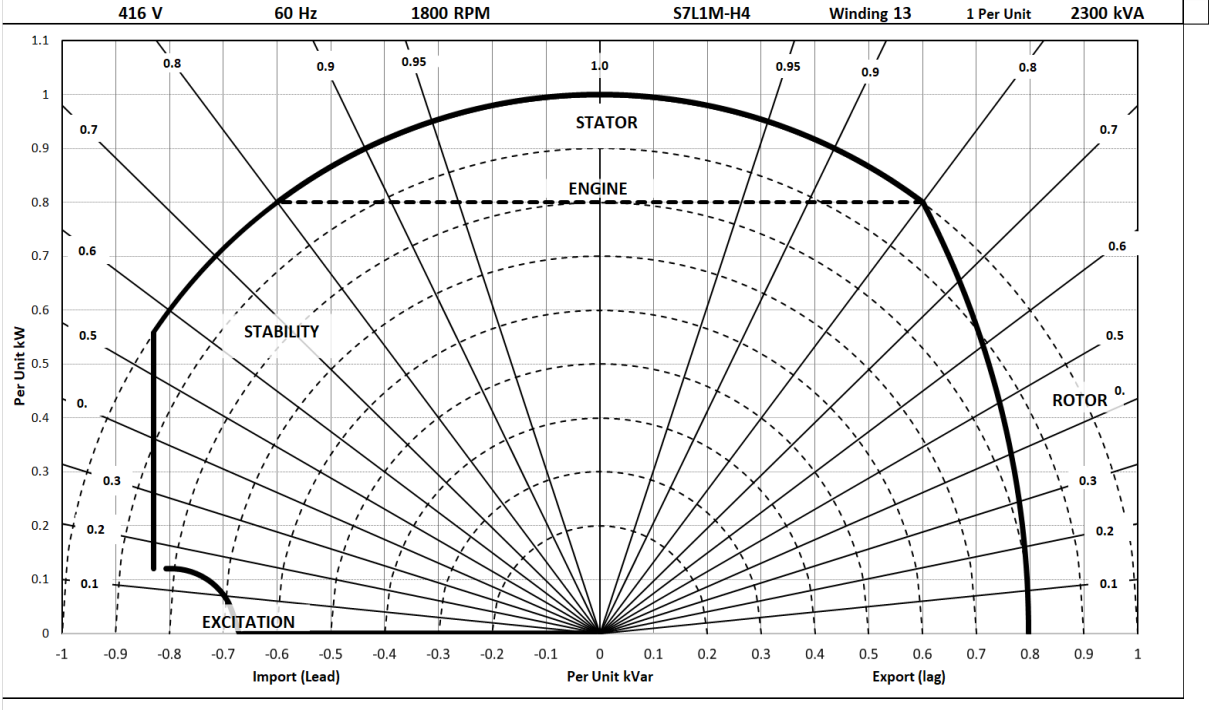

STAMFORD®

S7L1M-H4 Wdg.13

RATINGS AT 0.8 POWER FACTOR

| Class - Temp Rise | | Standby | Cont. H - 110/50°C | Cont. F - 90/50°C | Cont. B - 70/50°C |
|-------------------|-------------------|---------|--------------------|-------------------|-------------------|
| 50 Hz | Star (V) | N/A | N/A | N/A | N/A |
| | Parallel Star (V) | N/A | N/A | N/A | N/A |
| | Delta (V) | N/A | N/A | N/A | N/A |
| | kVA | N/A | N/A | N/A | N/A |
| | kW | N/A | N/A | N/A | N/A |
| | Efficiency (%) | N/A | N/A | N/A | N/A |
| | kW Input | N/A | N/A | N/A | N/A |

| | | | | | | | | | | | | | | | | | |
|-----------------|-------------------|-----|-----|-----|-----|------|------|------|-----|------|------|------|-----|------|------|------|-----|
| 60 Hz | Star (V) | 380 | 400 | 416 | N/A | 380 | 400 | 416 | N/A | 380 | 400 | 416 | N/A | 380 | 400 | 416 | N/A |
| | Parallel Star (V) | N/A | N/A | N/A | N/A | N/A | N/A | N/A | N/A | N/A | N/A | N/A | N/A | N/A | N/A | N/A | N/A |
| | Delta (V) | N/A | N/A | N/A | N/A | N/A | N/A | N/A | N/A | N/A | N/A | N/A | N/A | N/A | N/A | N/A | N/A |
| | kVA | N/A | N/A | N/A | N/A | 2300 | 2300 | 2300 | N/A | 2119 | 2119 | 2119 | N/A | 1894 | 1894 | 1894 | N/A |
| | kW | N/A | N/A | N/A | N/A | 1840 | 1840 | 1840 | N/A | 1695 | 1695 | 1695 | N/A | 1515 | 1515 | 1515 | N/A |
| | Efficiency (%) | N/A | N/A | N/A | N/A | 96.1 | 96.1 | 96.2 | N/A | 96.1 | 96.2 | 96.2 | N/A | 96.1 | 96.1 | 96.1 | N/A |
| | kW Input | N/A | N/A | N/A | N/A | 1915 | 1914 | 1913 | N/A | 1763 | 1763 | 1763 | N/A | 1576 | 1576 | 1577 | N/A |

De-rates

All values tabulated above are subject to the following reductions:

- 5% when air inlet filters are fitted
- 3% for every 500 meters by which the operating altitude exceeds 1000 meters above mean sea level
- 3% for every 5°C by which the operational ambient temperature exceeds 40°C @ Class H temperature rise (please refer to applications for ambient temperature de-rates at other temperature rise classes)
- For any other operating conditions impacting the cooling circuit please refer to applications

Note: Requirement for operating in an ambient exceeding 60°C and altitude exceeding 4000 meters (for <690V) or 1500 meters (for >690V) must be referred to applications.

Dimensional and Torsional Drawing

For dimensional and torsional information please refer to the alternator General Arrangement and rotor drawings available on our website (<http://stamford-avk.com/>)

Note: Continuous development of our products means that the information contained in our data sheets can change without notice, and specifications should always be confirmed with Cummins Generator Technologies prior to purchase.



Follow us @stamfordavk



Cummins Generator Technologies



View our videos at youtube.com/stamfordavk

news.stamford-avk.com

**For Applications Support:
applications@cummins.com**

**For Customer Service:
emea.service@cummins.com**

**For General Enquiries:
Stamford-avk@cummins.com**

Copyright 2016. Cummins Generator Technologies Ltd. All rights reserved.
Cummins and the Cummins logo are registered trade marks of Cummins Inc.
STAMFORD is a registered trade mark of Cummins Generator Technologies Ltd.

