

STAMFORD® | AvK®

HV 804 S WDG 87 - Technical Data Sheet

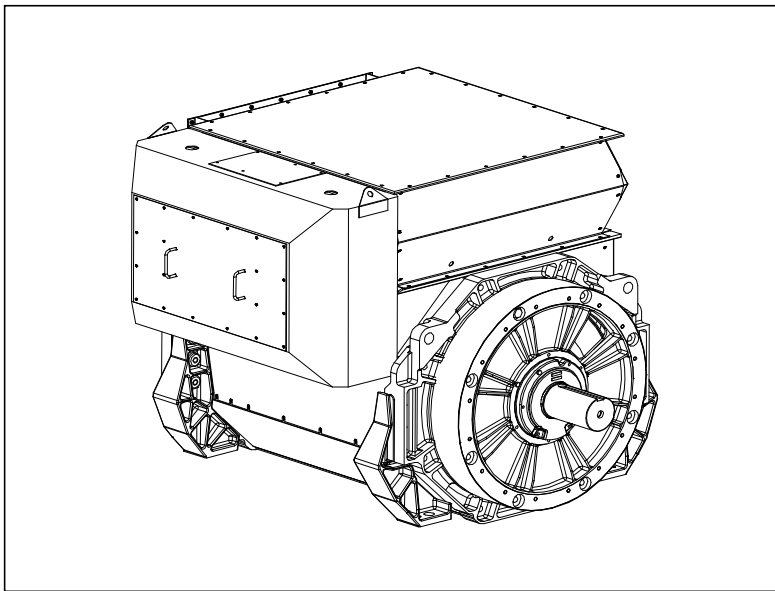

FRAME HV 804 S

SPECIFICATIONS & OPTIONS

STAMFORD | AvK

STANDARDS

Cummins Generator Technologies industrial generators meet the requirements of BS EN 60034 and the relevant sections of other national and international standards such as BS5000, VDE 0530, NEMA MG1-32, IEC60034, CSA C22.2-100, AS1359.

Other standards and certifications can be considered on request.

DESCRIPTION

The STAMFORD PI range of synchronous ac generators are brushless with a rotating field. They are separately excited by the STAMFORD Permanent Magnet Generator (PMG). This is a shaft mounted, high frequency, pilot exciter which provides a constant supply of clean power via the Automatic Voltage Regulator (AVR) to the main exciter. The main exciter output is fed to the main rotor, through a full wave bridge rectifier, protected by surge suppression.

VOLTAGE REGULATORS

The P80 range generators complete with a PMG are available with one AVR. Underspeed protection (UFRO) is also provided by the AVR. The UFRO will reduce the generator output voltage proportional to the speed of the generator below a pre-settable level.

The STAMFORD | AvK Digital Excitation Control System (DM110) is an electronic, solid-state, microprocessor based control device. The DM110 regulates the output voltage of a the ac generator by controlling the current into the generator exciter field. Input power to the DM110 is provided by a multi-pole, high-frequency, permanent magnet generator (PMG).

The DM110 is supplied in an encapsulated package designed for behind-the-panel mounting. Front panel indicators (LEDs) annunciate DM110 status and system conditions. DM110 connections are made through quarterinch, quick-connect terminals on the rear panel. A 9-pin DB-9 type connector on the rear panel provides communication between the DM110 and an IBM compatible PC.

Technical details on the DM110 are available on the Stamford-AvK website using the following URL:
<https://www.stamford-avk.com/downloads/avr-manuals>

WINDINGS & ELECTRICAL PERFORMANCE

All generator stators are wound to 2/3 pitch. This eliminates triplen (3rd, 9th, 15th ...) harmonics on the voltage waveform and is found to be the optimum design for trouble-free supply of non-linear loads. The 2/3 pitch design avoids excessive neutral currents sometimes seen with higher winding pitches. A fully connected damper winding reduces oscillations during paralleling. This winding, with the 2/3 pitch and carefully selected pole and tooth designs, ensures very low levels of voltage waveform distortion.

TERMINALS & TERMINAL BOX

Standard generators feature a main stator with 6 ends brought out to the terminals, which are mounted on the frame at the non-drive end of the generator. A sheet steel terminal box contains the AVR and provides ample space for the customers' wiring and gland arrangements. It has removable panels for easy access.

SHAFT & KEYS

All generator rotors are dynamically balanced to better than BS6861:Part 1 Grade 2.5 for minimum vibration in operation. Two bearing generators are balanced with a half key.

INSULATION/IMPREGNATION

The insulation system is class 'F'. All wound components are impregnated with materials and processes designed specifically to provide the high build required for static windings and the high mechanical strength required for rotating components.

QUALITY ASSURANCE

Generators are manufactured using production procedures having a quality assurance level to BS EN ISO 9001.

NOTE ON REGULATION

The stated voltage regulation may not be maintained in the presence of certain radio transmitted signals. Any change in performance will fall within the limits of Criteria 'B' of EN 61000-6-2:2001. At no time will the steady-state voltage regulation exceed 2%.

NB Continuous development of our products entitles us to change specification details without notice, therefore they must not be regarded as binding.

Front cover drawing is typical of the product range.

FRAME HV 804 S

WINDING 87

RATINGS	REFER TO SALES AND SERVICE BRIEFING
MAXIMUM ALTITUDE	1000 METRES ABOVE SEA LEVEL
MAXIMUM AMBIENT TEMPERATURE	40° C
CONTROL SYSTEM SERIES 3	SEPARATELY EXCITED BY P.M.G.
A.V.R.	FULL WAVE RECTIFIED
VOLTAGE REGULATION	± 0.25%
SUSTAINED SHORT CIRCUIT	REFER TO SHORT CIRCUIT DECREMENT CURVES OF THIS SECTION
INSULATION SYSTEM	CLASS F
PROTECTION	IP23 STANDARD
RATED POWER FACTOR	0.8
STATOR WINDING	DOUBLE LAYER LAP
WINDING PITCH	2/3
WINDING LEADS	6
R.F.I. SUPPRESSION	BS EN 50081/2-1/2 VDE 0875G VDE 0875N For other standards apply to the factory
WAVEFORM DISTORTION	NO LOAD < 1.5% NON-DISTORTING BALANCED LINEAR LOAD < 3.0%
MAXIMUM OVERSPEED	2250 Rev/Min
BEARING DRIVE END	ISO 6232 C3
BEARING NON DRIVE END	ISO 6324 C3
EFFICIENCY	REFER TO EFFICIENCY CURVES OF THIS SECTION
FREQUENCY	60Hz
TELEPHONE INTERFERENCE	TIF < 50
COOLING AIR	3.5 m ³ /sec
VOLTAGE STAR (Y)	12470
kVA BASE RATING FOR REACTANCE VALUES	2900
X _d DIRECT AXIS SYNCHRONOUS	1.900
X' _d DIRECT AXIS TRANSIENT	0.172
X'' _d DIRECT AXIS SUB-TRANSIENT	0.128
X _q QUADRATURE AXIS REACTANCE	1.430
X'' _q QUAD. AXIS SUB-TRANSIENT	0.238
X _L LEAKAGE REACTANCE	0.095
X ₂ NEGATIVE PHASE SEQUENCE	0.184
X ₀ ZERO PHASE SEQUENCE	0.028
REACTANCES ARE SATURATED	VALUES ARE PER UNIT AT RATING AND VOLTAGE INDICATED
T' _d TRANSIENT TIME CONSTANT	0.203
T'' _d SUB-TRANSIENT TIME CONSTANT	0.015
T' _{do} O.C. FIELD TIME CONSTANT	4.150
T _a ARMATURE TIME CONSTANT	0.058
SHORT CIRCUIT RATIO	1/X _d
STATOR WINDING RESISTANCE (L-N)	0.4272
ROTOR WINDING RESISTANCE	1.400
EXCITER STATOR FIELD RESISTANCE	17.50
EXCITER ROTOR RESISTANCE (L-L)	0.076
PMG STATOR RESISTANCE (L-L)	3.800
	RESISTANCE VALUES ARE IN OHMS AT 20° C
NO LOAD EXCITATION VOLTAGE	15.0
FULL LOAD EXCITATION VOLTAGE	63.0

Continuous development of our products entitles us to change specification details without notice, therefore they must not be regarded as binding.

THREE PHASE EFFICIENCY CURVES

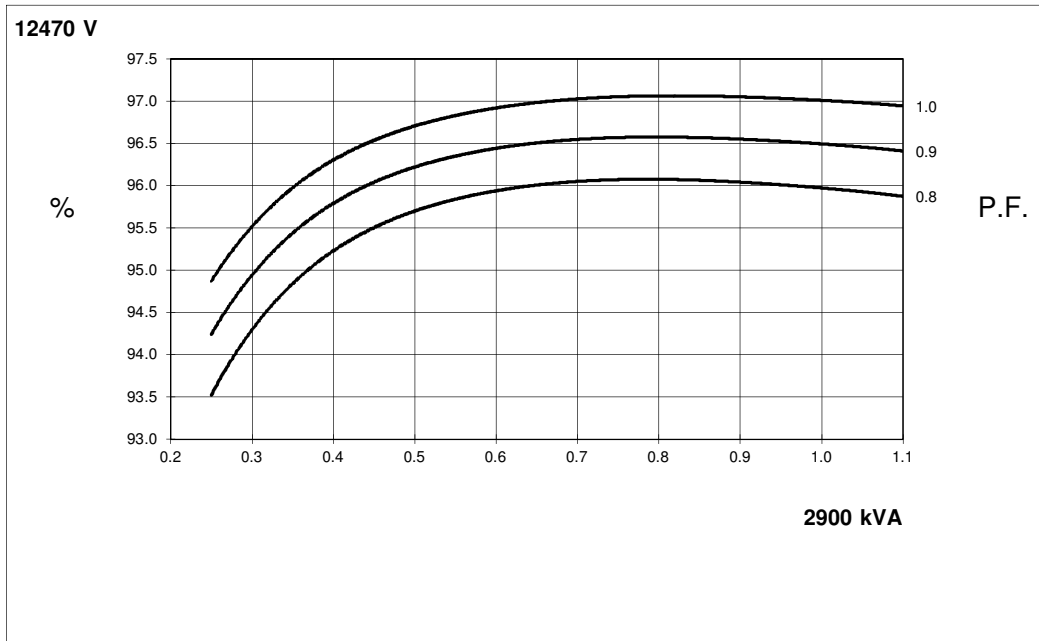

FULL WAVE RECTIFIED AVR
 LOCKED ROTOR MOTOR STARTING CURVE

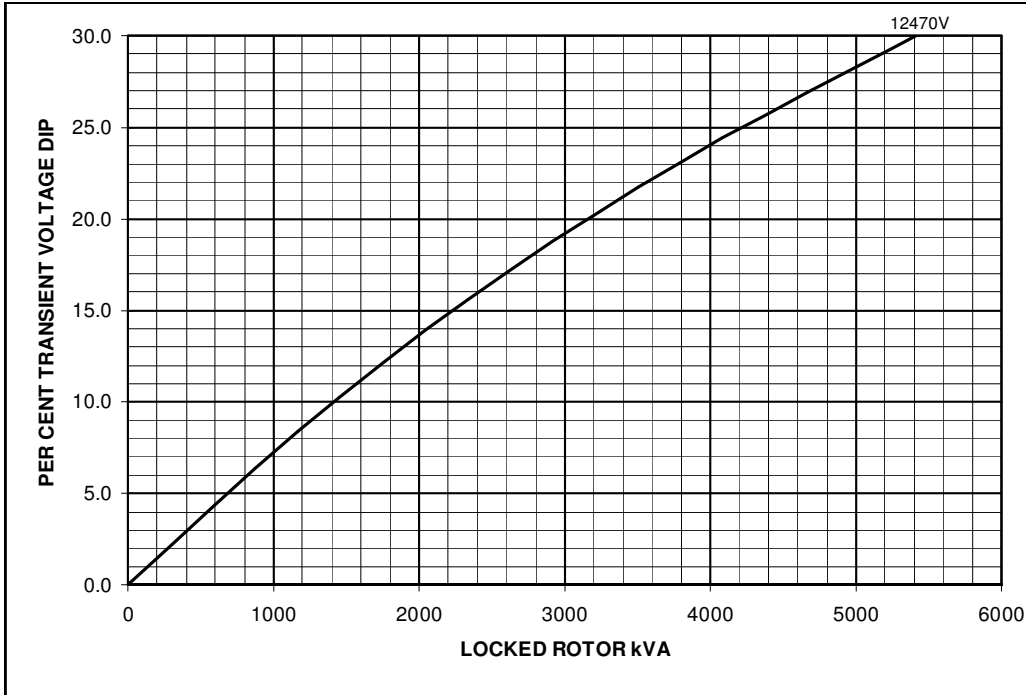

FRAME HV 804 S WDG 87 60Hz

Three Phase Short Circuit Decrement Curve
 No- Load Excitation at Rated Speed

Based on series star (wye) connection

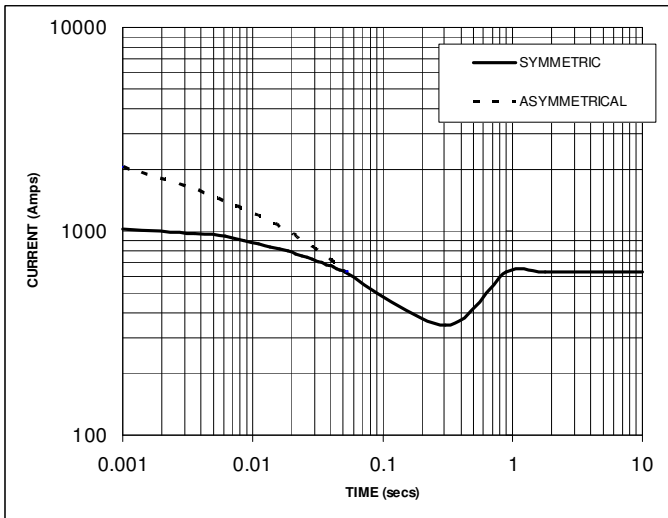

NOTE 1

THE FOLLOWING MULTIPLICATION FACTORS SHOULD BE USED TO ADJUST THE VALUES FROM CURVES BETWEEN THE 0.001 SECONDS AND THE MINIMUM CURRENT POINT IN RESPECT OF NOMINAL OPERATING VOLTAGE

VOLTAGE	FACTOR
12470V	X 1.00

THE SUSTAINED CURRENT VALUE IS CONSTANT IRRESPECTIVE OF VOLTAGE LEVEL

NOTE 2

THE FOLLOWING MULTIPLICATION FACTORS SHOULD BE USED TO CONVERT THE VALUES CALCULATED IN ACCORDANCE WITH NOTE 1 TO THOSE APPLICABLE

TO THE VARIOUS TYPES OF SHORT CIRCUIT

	3 PHASE	2 PHASE L-L	1 PHASE L-N
INSTANTANEOUS	X 1.0	X 0.87	X 1.30
MINIMUM	X 1.0	X 1.80	X 3.20
SUSTAINED	X 1.0	X 1.50	X 2.50
MAX SUSTAINED DURATION	10 SEC	5 SEC	2 SEC

ALL OTHER TIMES ARE UNCHANGED

SUSTAINED SHORT CIRCUIT = 631 Amps

FRAME HV 804 S
WINDING 87 0.8 Power Factor

STAMFORD | AvK

RATINGS

Class - Temp Rise	Cont. F - 105/40°C	Cont. H - 125/40°C	Class F Standby - 125/40°C	Class F Standby - 138/27°C
50Hz Star (V)	N/A	N/A	N/A	N/A
kVA	N/A	N/A	N/A	N/A
kW	N/A	N/A	N/A	N/A
Efficiency (%)	N/A	N/A	N/A	N/A
kW Input	N/A	N/A	N/A	N/A
60Hz Star (V)	12470	12470	12470	12470
kVA	2900	N/A	3090	3220
kW	2320	N/A	2472	2576
Efficiency (%)	96.0	N/A	95.9	95.9
kW Input	2417	N/A	2578	2687

TYPICAL DIMENSIONS - Further arrangements available - please refer to factory

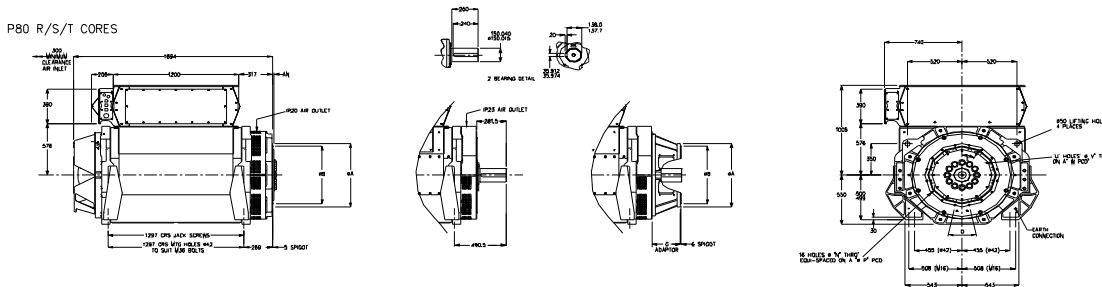

P80 R/S/T CORES					
1-BRG ADAPTORS					
SAE	A	B	N	P	D
SAE 0 711	647.7	14	679.5	22.0°	
SAE 00 883	787.4	14	851.0	22.5°	

P80 R/S/T/W/X CORES						
1-BRG COUPLING DISC						
SAE	AN	C	U	V	W	E
18	15.9	571.4	12	16.7	543.0	30°
21	0	673.0	12	16.7	641.3	30°
24	0	733.3	12	20.7	692.0	30°

P80 R/S/T/W/X CORES		
2-BRG ADAPTORS		
SAE	F	G
P80 R/S/T	0	271.5
P80 R/S/T	00	271.5
P80 W/X	0	271.5
P80 W/X	00	329.0

P80 R/S/T/W/X CORES					
2-BRG ADAPTORS					
SAE	A	B	N	P	D
SAE 0 711	647.7	14	679.5	22.0°	
SAE 00 883	787.4	14	851.0	22.5°	

P80 W/X CORES

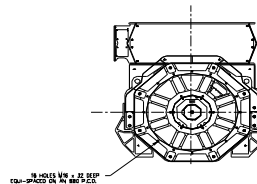
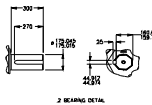
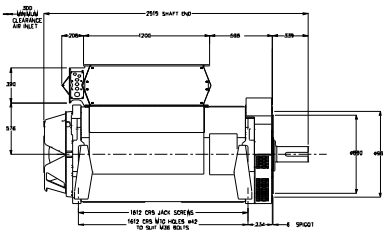

STAMFORD | AvK