

# STAMFORD®

**PM734C - Winding 312**

Technical  Data Sheet

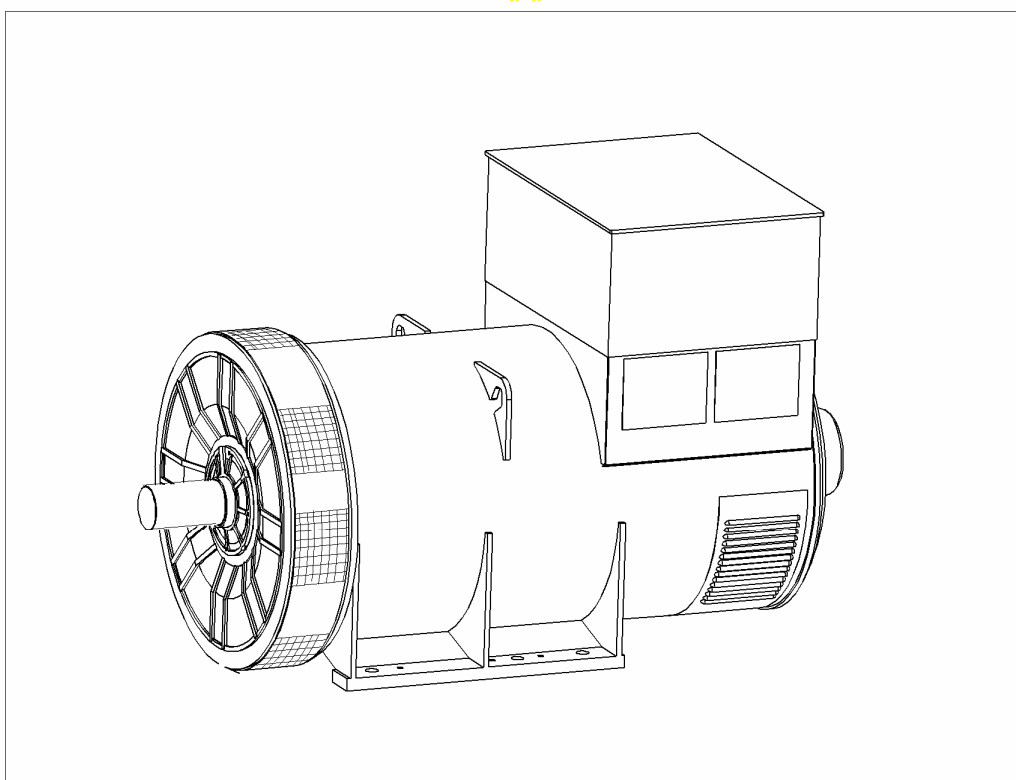

## SPECIFICATIONS &amp; OPTIONS

**STANDARDS**

Marine generators may be certified to Lloyds, DnV, Bureau Veritas, ABS, Germanischer-Lloyd or RINA. Other standards and certifications can be considered on request.

**DESCRIPTION**

The STAMFORD PM range of synchronous ac generators are brushless with a rotating field. They are separately excited by the STAMFORD Permanent Magnet Generator (PMG). This is a shaft mounted, high frequency, pilot exciter which provides a constant supply of clean power via the Automatic Voltage Regulator (AVR) to the main exciter. The main exciter output is fed to the main rotor, through a full wave bridge rectifier, protected by surge suppression.

**VOLTAGE REGULATORS**

The PM range generators, complete with PMG, are available with one of two AVRs. Each AVR has soft start voltage build up and built in protection against sustained over-excitation, which will de-excite the generator after a minimum of 8 seconds.

Underspeed protection (UFRO) is also provided on both AVRs. The UFRO will reduce the generator output voltage proportional to the speed of the generator below a pre-settable level.

The **MX341 AVR** is two phase sensed with a voltage regulation of  $\pm 1\%$ . (see the note on regulation).

The **MX321 AVR** is 3 phase rms sensed with a voltage regulation of 0.5% rms (see the note on regulation). The UFRO circuit has adjustable slope and dwell for controlled recovery from step loads. An over voltage protection circuit will shutdown the output device of the AVR, it can also trip an optional excitation circuit breaker if required. As an option, short circuit current limiting is available with the addition of current transformers.

The above AVRs require a generator mounted current transformer to provide quadrature droop characteristics for load sharing during parallel operation. Provision is also made for the connection of the STAMFORD power factor controller, for embedded applications, and a remote voltage trimmer.

**WINDINGS & ELECTRICAL PERFORMANCE**

All generator stators are wound to 2/3 pitch. This eliminates triplen (3rd, 9th, 15th ...) harmonics on the voltage waveform and is found to be the optimum design for trouble-free supply of non-linear loads.

The 2/3 pitch design avoids excessive neutral currents sometimes seen with higher winding pitches. A fully connected damper winding reduces oscillations during paralleling. This winding, with the 2/3 pitch and carefully selected pole and tooth designs, ensures very low levels of voltage waveform distortion.

**TERMINALS & TERMINAL BOX**

Standard generators feature a main stator with 6 ends brought out to the terminals, which are mounted on the frame at the non-drive end of the generator. A sheet steel terminal box contains the AVR and provides ample space for the customers' wiring and gland arrangements. It has removable panels for easy access.

**SHAFT & KEYS**

All generator rotors are dynamically balanced to better than BS6861:Part 1 Grade 2.5 for minimum vibration in operation. Two bearing generators are balanced with a half key.

**INSULATION/IMPREGNATION**

The insulation system is class 'H', and meets the requirements of UL1446.

All wound components are impregnated with materials and processes designed specifically to provide the high build required for static windings and the high mechanical strength required for rotating components.

**QUALITY ASSURANCE**

Generators are manufactured using production procedures having a quality assurance level to BS EN ISO 9001.

**NOTE ON REGULATION**

The stated voltage regulation may not be maintained in the presence of certain radio transmitted signals.

Any change in performance will fall within the limits of Criteria 'B' of EN 61000-6-2:2001. At no time will the steady-state voltage regulation exceed 2%.

**DE RATES**

All values tabulated on page 8 are subject to the following reductions

5% when air inlet filters are fitted.

10% when IP44 Filters are fitted.

3% for every 500 metres by which the operating altitude exceeds 1000 metres above mean sea level.

3% for every 5°C by which the operational ambient temperature exceeds 50°C.

Note: Requirement for operating in an ambient temperature exceeding 60°C must be referred to the factory.

Continuous development of our products entitles us to change specification details without notice, therefore they must not be regarded as binding.

Front cover drawing is typical of the product range.

APPROVED DOCUMENT

# PM734C



## WINDING 312

CONTROL SYSTEM	SEPARATELY EXCITED BY P.M.G.		
A.V.R.	MX341	MX321	
VOLTAGE REGULATION	± 1%	± 0.5 %	With 4% ENGINE GOVERNING
SUSTAINED SHORT CIRCUIT	REFER TO SHORT CIRCUIT DECREMENT CURVES (page 7)		

INSULATION SYSTEM	CLASS H
PROTECTION	IP23
RATED POWER FACTOR	0.8
STATOR WINDING	DOUBLE LAYER LAP
WINDING PITCH	TWO THIRDS
WINDING LEADS	6
MAIN STATOR RESISTANCE	0.00126 Ohms PER PHASE AT 22°C STAR CONNECTED
MAIN ROTOR RESISTANCE	1.85 Ohms at 22°C
EXCITER STATOR RESISTANCE	17.5 Ohms at 22°C
EXCITER ROTOR RESISTANCE	0.063 Ohms PER PHASE AT 22°C
R.F.I. SUPPRESSION	BS EN 61000-6-2 & BS EN 61000-6-4, VDE 0875G, VDE 0875N. refer to factory for others
WAVEFORM DISTORTION	NO LOAD < 1.5% NON-DISTORTING BALANCED LINEAR LOAD < 5.0%
MAXIMUM OVERSPEED	2250 Rev/Min
BEARING DRIVE END	BALL. 6228 C3
BEARING NON-DRIVE END	BALL. 6319 C3

	1 BEARING	2 BEARING
WEIGHT COMP. GENERATOR	3018 kg	2967 kg
WEIGHT WOUND STATOR	1445 kg	1445 kg
WEIGHT WOUND ROTOR	1257 kg	1195 kg
WR <sup>2</sup> INERTIA	37.3309 kgm <sup>2</sup>	36.33 kgm <sup>2</sup>
SHIPPING WEIGHTS in a crate	3091kg	3036kg
PACKING CRATE SIZE	194 x 105 x 154(cm)	194 x 105 x 154(cm)

	50 Hz	60 Hz
TELEPHONE INTERFERENCE	THF<2%	TIF<50
COOLING AIR	2.69 m <sup>3</sup> /sec 5700 cfm	3.45 m <sup>3</sup> /sec 7300 cfm

	380/220	400/231	415/240	440/254	416/240	440/254	460/266	480/277
VOLTAGE STAR								
kVA BASE RATING FOR REACTANCE VALUES	1180	1240	1265	1240	1390	1480	1510	1540
X <sub>d</sub> DIR. AXIS SYNCHRONOUS	2.50	2.37	2.24	1.96	3.15	2.99	2.80	2.62
X' <sub>d</sub> DIR. AXIS TRANSIENT	0.15	0.14	0.14	0.12	0.19	0.18	0.17	0.16
X'' <sub>d</sub> DIR. AXIS SUBTRANSIENT	0.11	0.11	0.10	0.09	0.14	0.13	0.13	0.12
X <sub>q</sub> QUAD. AXIS REACTANCE	1.61	1.53	1.45	1.26	2.03	1.93	1.80	1.69
X'' <sub>q</sub> QUAD. AXIS SUBTRANSIENT	0.23	0.21	0.20	0.18	0.28	0.27	0.25	0.24
X <sub>L</sub> LEAKAGE REACTANCE	0.03	0.03	0.03	0.02	0.04	0.03	0.03	0.03
X <sub>2</sub> NEGATIVE SEQUENCE	0.16	0.15	0.14	0.13	0.20	0.19	0.18	0.17
X <sub>0</sub> ZERO SEQUENCE	0.02	0.02	0.02	0.02	0.02	0.02	0.02	0.02

REACTANCES ARE SATURATED

VALUES ARE PER UNIT AT RATING AND VOLTAGE INDICATED

T' <sub>d</sub> TRANSIENT TIME CONST.	0.135s
T'' <sub>d</sub> SUB-TRANSTIME CONST.	0.01s
T' <sub>do</sub> O.C. FIELD TIME CONST.	2.23s
T <sub>a</sub> ARMATURE TIME CONST.	0.02s
SHORT CIRCUIT RATIO	1/X <sub>d</sub>

50  
Hz

PM734C  
Winding 312

STAMFORD

THREE PHASE EFFICIENCY CURVES

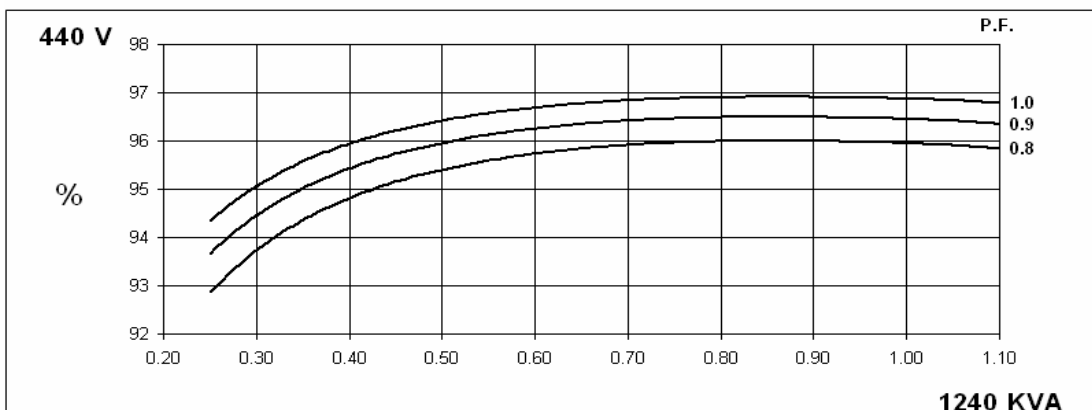
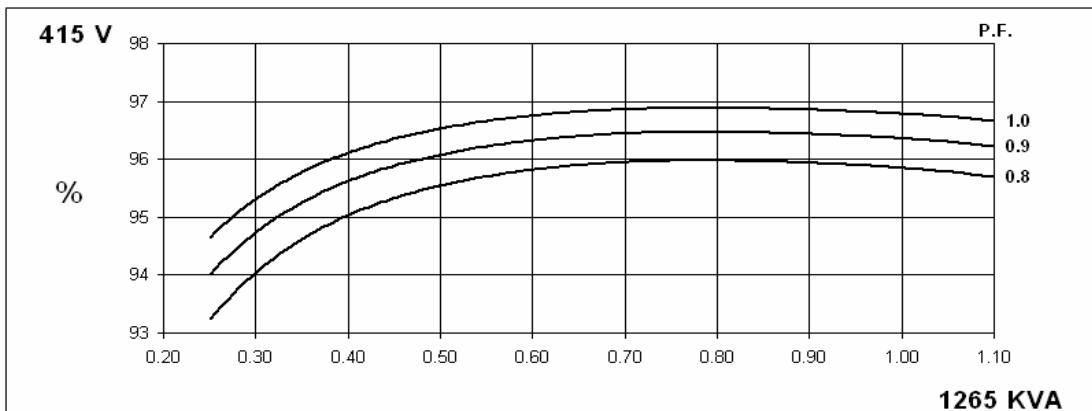
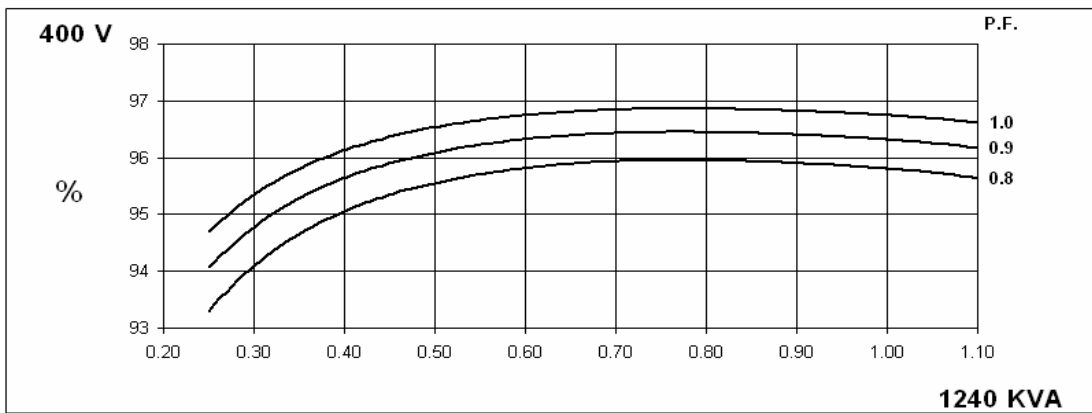
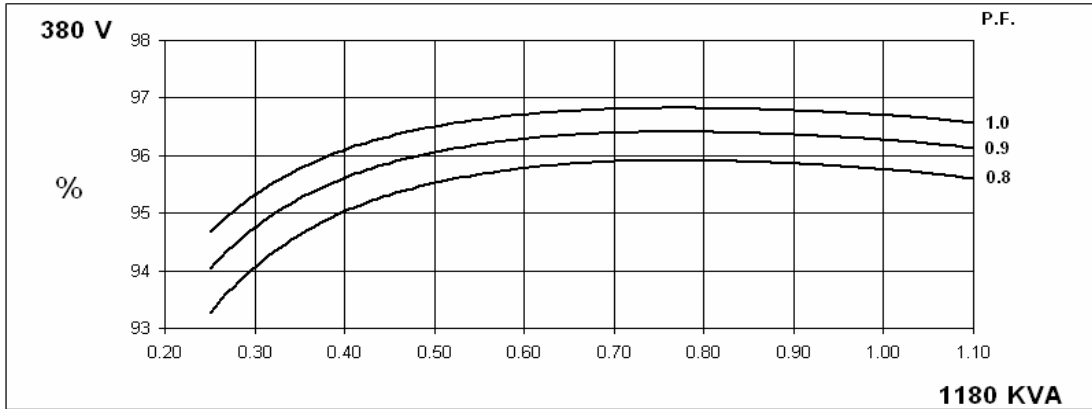

60  
Hz

PM734C  
Winding 312

STAMFORD

THREE PHASE EFFICIENCY CURVES

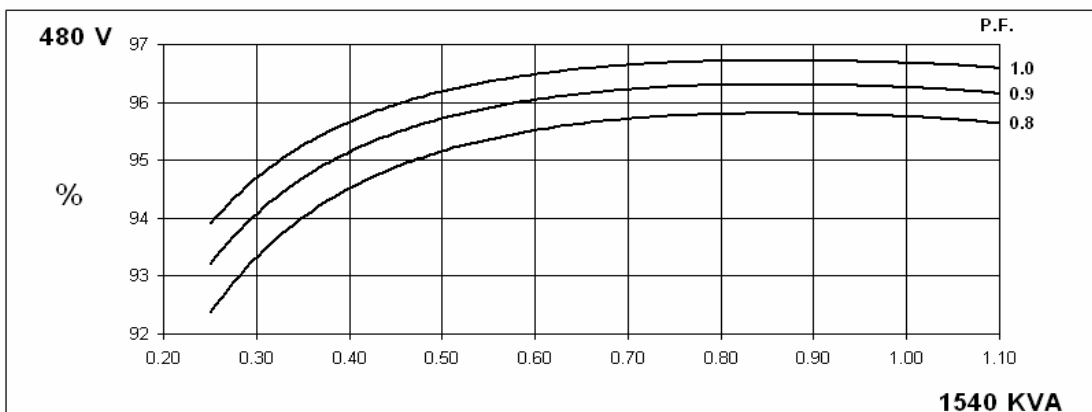
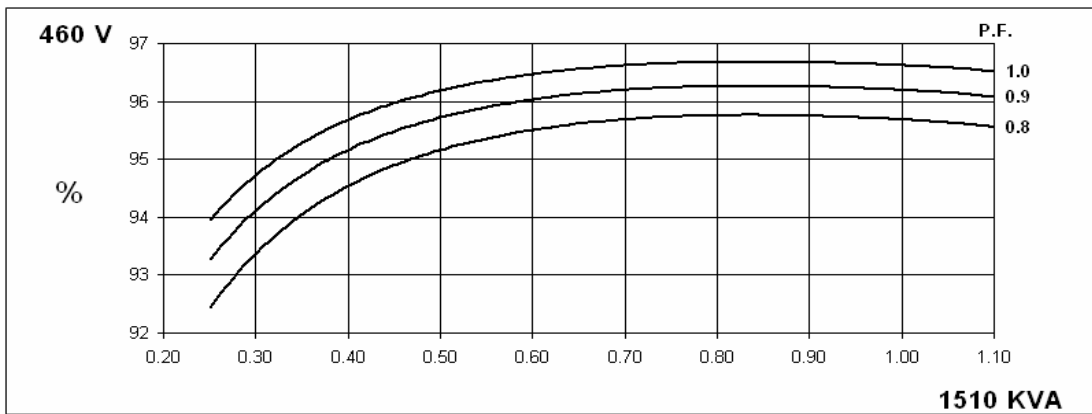
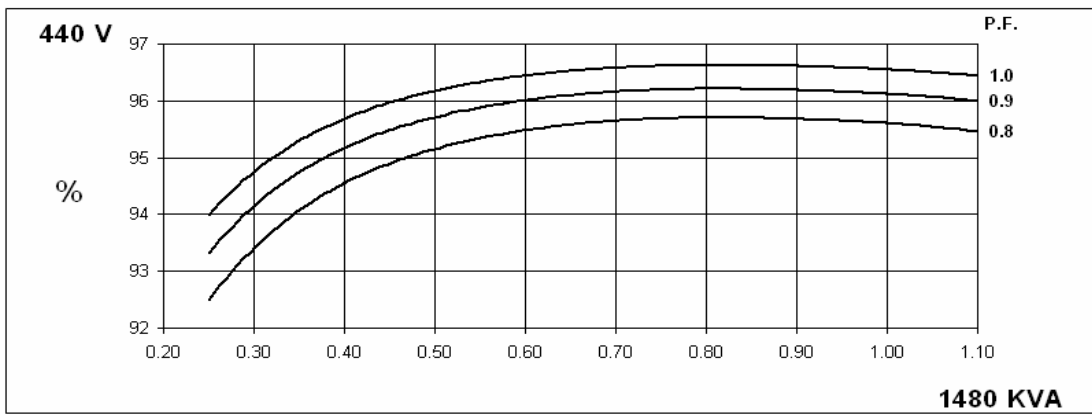
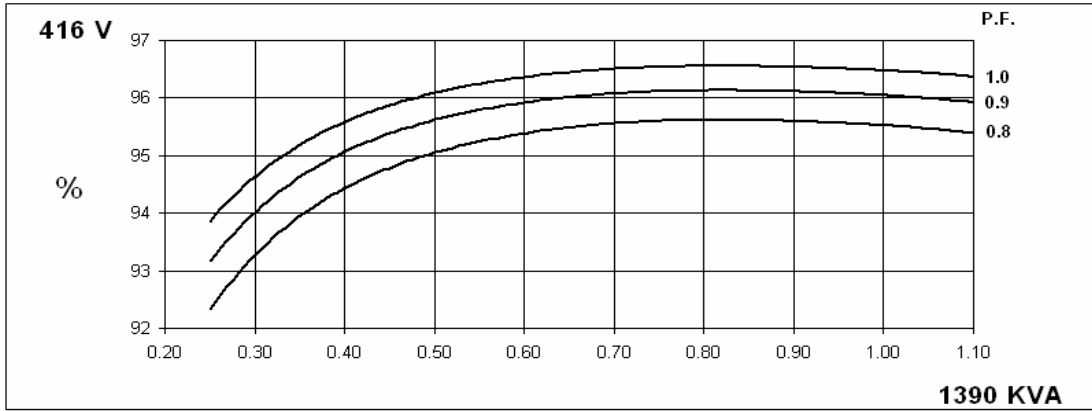

PM734C  
Winding 312

STAMFORD

Locked Rotor Motor Starting Curve

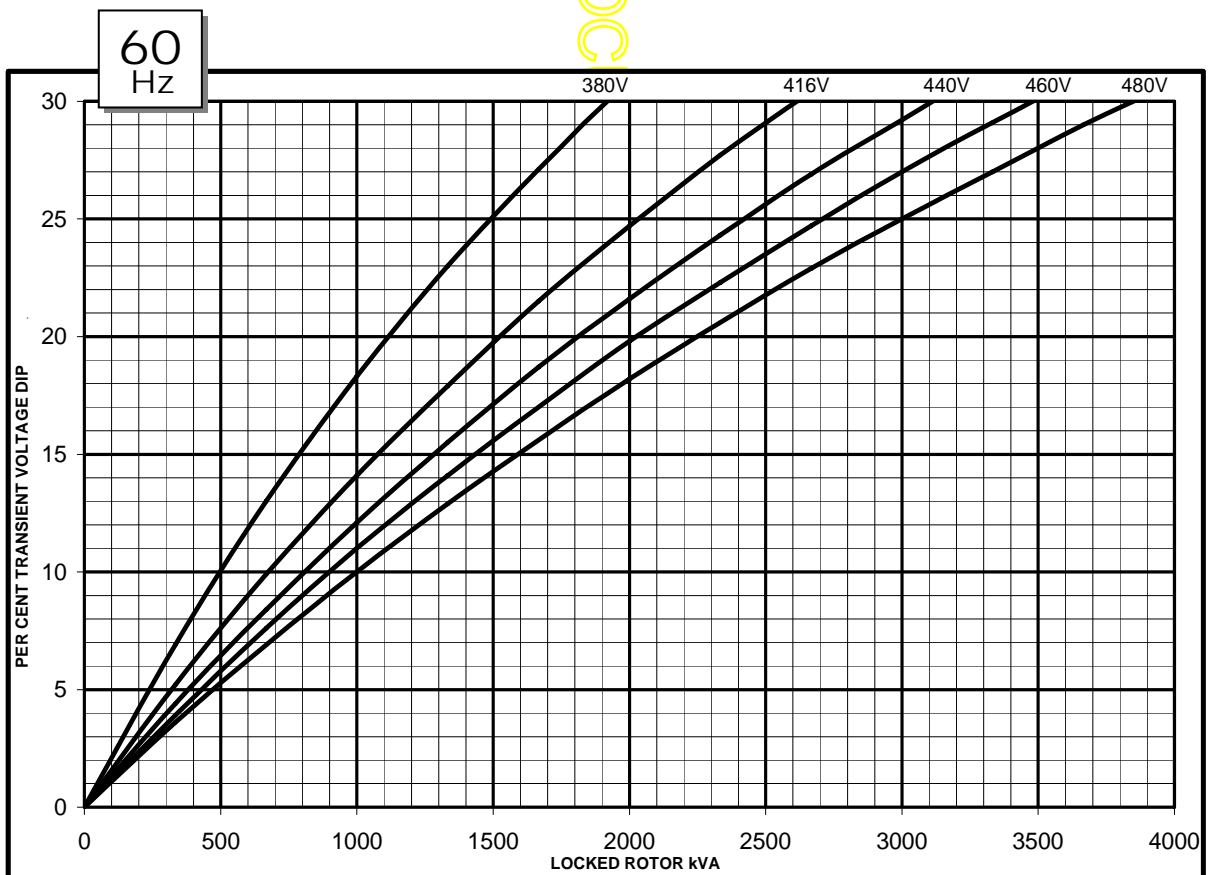
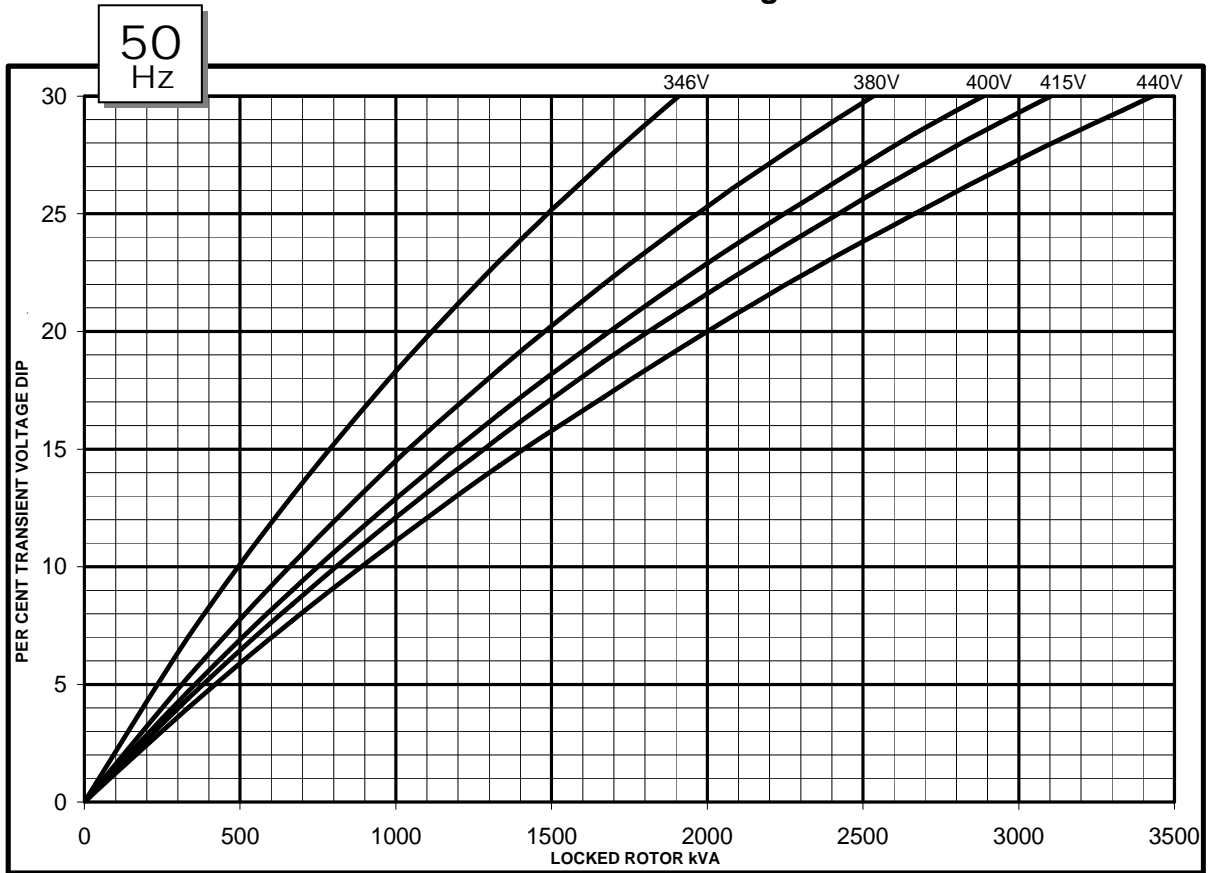

PM734C  
Winding 312

**STAMFORD**

**Three-phase Short Circuit Decrement Curve. No-load Excitation at Rated Speed  
Based on star (wye) connection.**

50  
Hz

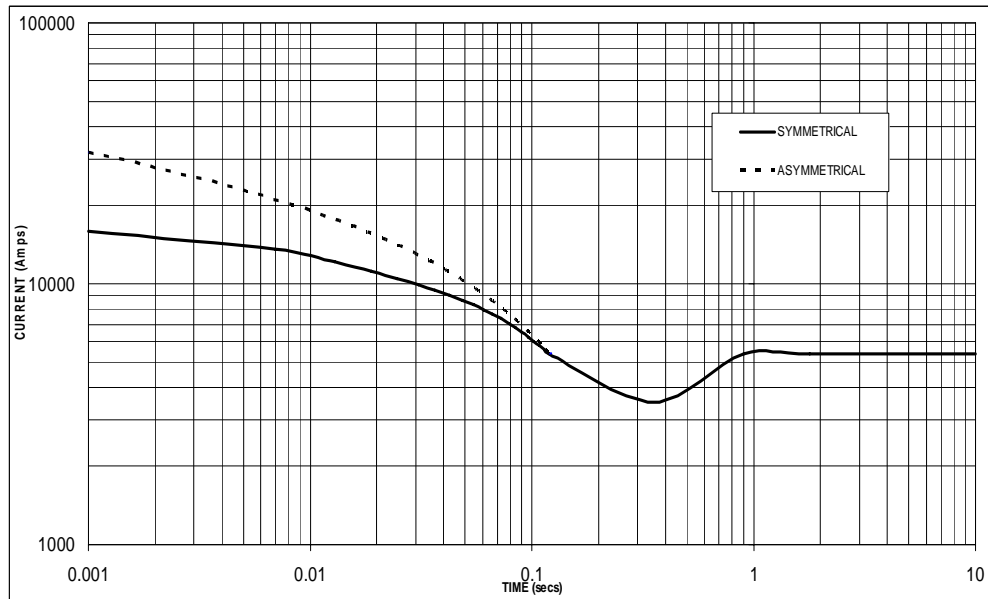

Sustained Short Circuit = 5,400 Amps

60  
Hz

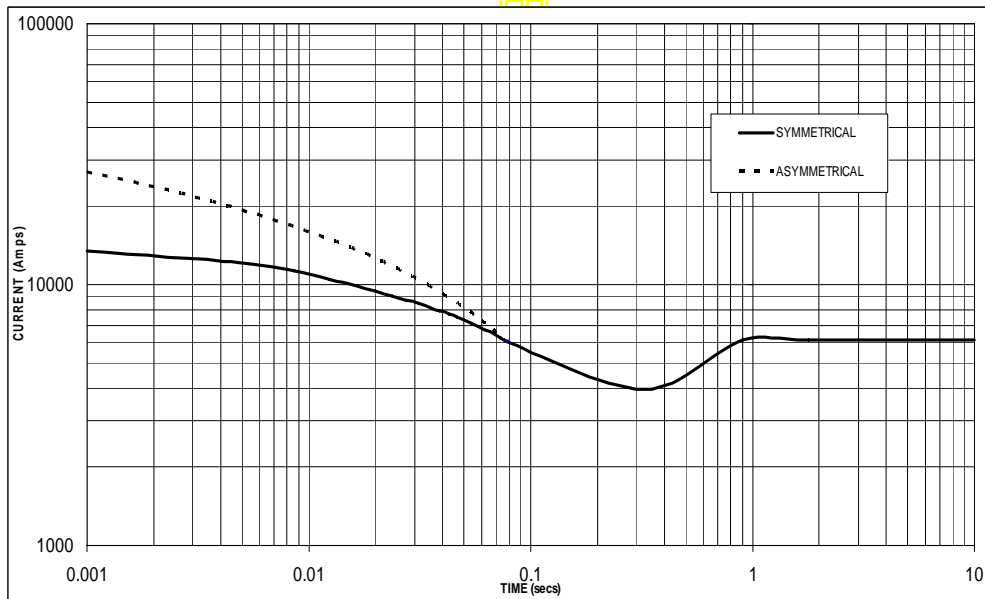

Sustained Short Circuit = 6,100 Amps

**Note 1**

The following multiplication factors should be used to adjust the values from curve between time 0.001 seconds and the minimum current point in respect of nominal operating voltage :

50Hz		60Hz	
Voltage	Factor	Voltage	Factor
380v	x 1.00	416v	x 1.00
400v	x 1.05	440v	x 1.06
415v	x 1.09	460v	x 1.10
440v	x 1.16	480v	x 1.15

The sustained current value is constant irrespective of voltage level

**Note 2**

The following multiplication factor should be used to convert the values calculated in accordance with NOTE 1 to those applicable to the various types of short circuit :

	3-phase	2-phase L-L	1-phase L-N
Instantaneous	x 1.00	x 0.87	x 1.30
Minimum	x 1.00	x 1.80	x 3.20
Sustained	x 1.00	x 1.50	x 2.50
Max. sustained duration	10 sec.	5 sec.	2 sec.

All other times are unchanged

**Note 3**

Curves are drawn for Star (Wye) connected machines.

Winding 312 / 0.8 Power Factor

**RATINGS**

Class - Temp Rise		Cont. B - 70/50°C				Cont. F - 90/50°C			
<b>50Hz</b>	Star (V)	380	400	415	440	380	400	415	440
	kVA	1085	1115	1115	1095	1180	1240	1265	1240
	kW	868	892	892	876	944	992	1012	992
	Efficiency (%)	95.8	95.9	96.0	96.0	95.8	95.8	95.8	96.0
	kW Input	906	930	929	913	985	1035	1056	1033

<b>60Hz</b>	Star (V)	416	440	460	480	416	440	460	480
	kVA	1225	1305	1335	1360	1390	1480	1510	1540
	kW	980	1044	1068	1088	1112	1184	1208	1232
	Efficiency (%)	95.6	95.7	95.8	95.8	95.5	95.6	95.7	95.8
	kW Input	1025	1091	1115	1136	1164	1238	1262	1286

**DIMENSIONS**

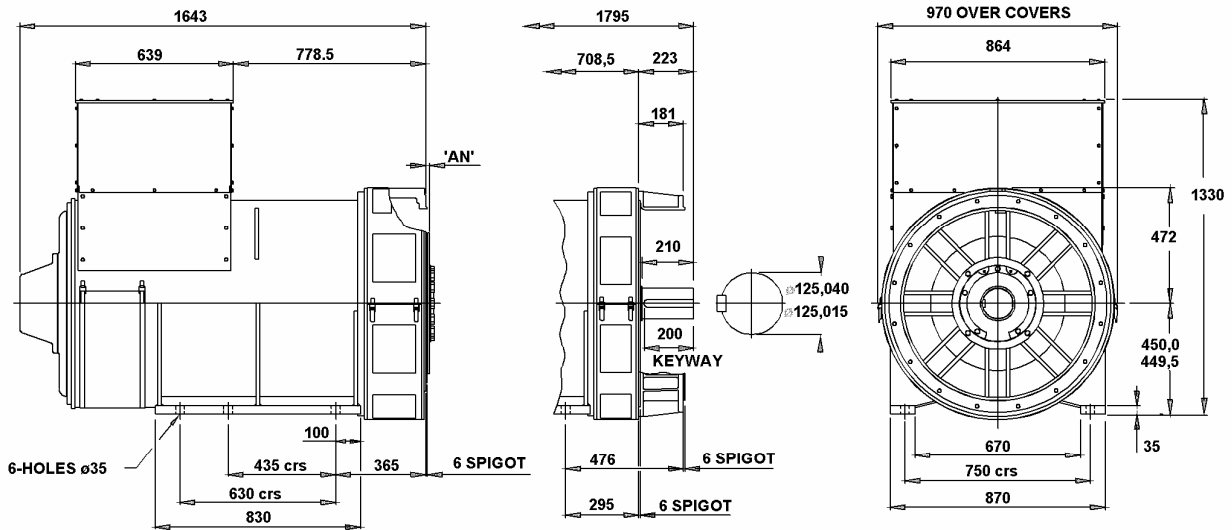

COUPLING DISC	'AN'
S.A.E No 18	15,7
S.A.E No 21	0
S.A.E No 24	0

1-BRG ADAPTORS
S.A.E No 0
S.A.E No 00

2-BRG ADAPTORS
S.A.E No 0
S.A.E No 00



APPROVED DOCUMENT

## **STAMFORD**

Head Office Address:  
Barnack Road, Stamford  
Lincolnshire, PE9 2NB  
United Kingdom  
Tel: +44 (0) 1780 484000  
Fax: +44 (0) 1780 484100

[www.cumminsgeneratortechnologies.com](http://www.cumminsgeneratortechnologies.com)

Copyright 2010, Cummins Generator Technologies Ltd, All Rights Reserved  
Stamford and AvK are registered trade marks of Cummins Generator Technologies Ltd  
Cummins and the Cummins logo are registered trade marks of Cummins Inc.