

STAMFORD®

UCM224F - Winding 311 Single Phase

Technical Data Sheet

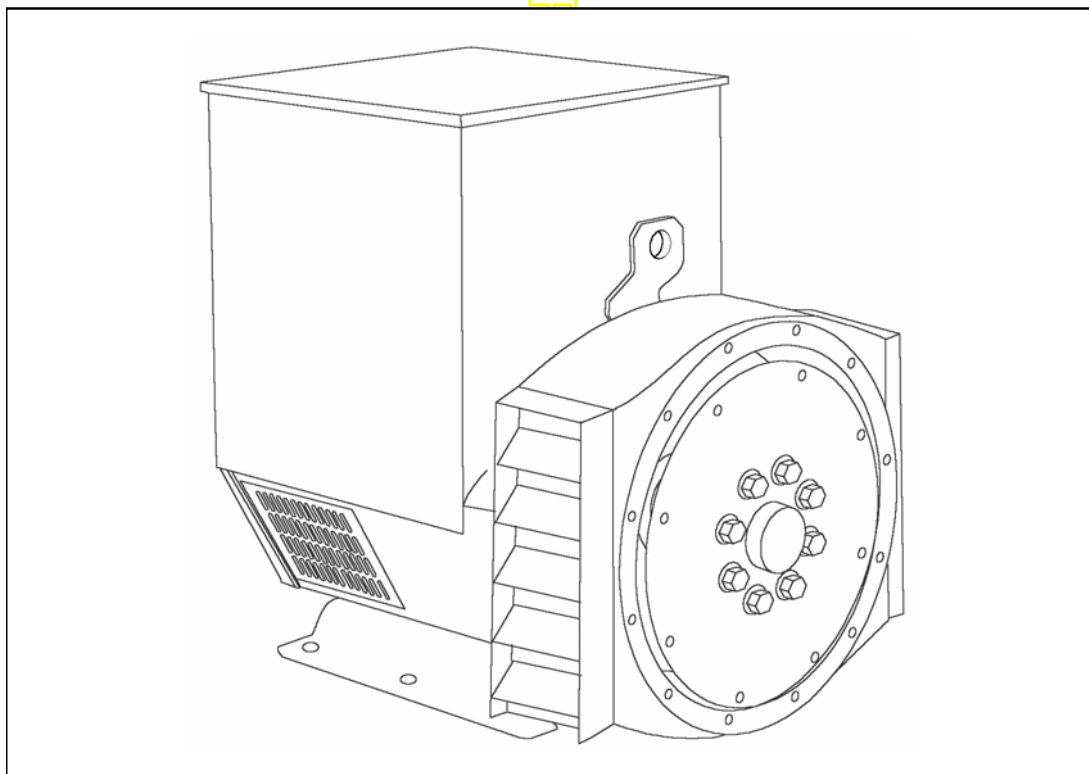

UCM224F

SPECIFICATIONS & OPTIONS

STAMFORD

STANDARDS

Marine generators may be certified to Lloyds, DnV, Bureau Veritas, ABS, Germanischer-Lloyd or RINA. Other standards and certifications can be considered on request.

VOLTAGE REGULATORS

MX341 AVR - STANDARD

This sophisticated Automatic Voltage Regulator (AVR) is incorporated into the Stamford Permanent Magnet Generator (PMG) control system, and is standard on marine generators of this type.

The PMG provides power via the AVR to the main exciter, giving a source of constant excitation power independent of generator output. The main exciter output is then fed to the main rotor, through a full wave bridge, protected by a surge suppressor. The AVR has in-built protection against sustained over-excitation, caused by internal or external faults. This de-excites the machine after a minimum of 5 seconds.

An engine relief load acceptance feature can enable full load to be applied to the generator in a single step.

If three-phase sensing is required with the PMG system the MX321 AVR must be used.

We recommend three-phase sensing for applications with greatly unbalanced or highly non-linear loads.

MX321 AVR

The most sophisticated of all our AVRs combines all the features of the MX341 with, additionally, three-phase rms sensing, for improved regulation and performance.

Over voltage protection is built-in and short circuit current level adjustments is an optional facility.

WINDINGS & ELECTRICAL PERFORMANCE

All generator stators are wound to 2/3 pitch. This eliminates triplen (3rd, 9th, 15th ...) harmonics on the voltage waveform and is found to be the optimum design for trouble-free supply of non-linear loads. The 2/3 pitch design avoids excessive neutral currents sometimes seen with higher winding pitches, when in parallel with the mains. A fully connected damper winding reduces oscillations during paralleling. This winding, with the 2/3 pitch and carefully selected pole and tooth designs, ensures very low waveform distortion.

TERMINALS & TERMINAL BOX

Standard generators are 3-phase reconnectable with 12 ends brought out to the terminals, which are mounted on a cover at the non-drive end of the generator. A sheet steel terminal box contains the AVR and provides ample space for the customers' wiring and gland arrangements. It has removable panels for easy access.

SHAFT & KEYS

All generator rotors are dynamically balanced to better than BS6861:Part 1 Grade 2.5 for minimum vibration in operation. Two bearing generators are balanced with a half key.

INSULATION/IMPREGNATION

The insulation system is class 'H'.

All wound components are impregnated with materials and processes designed specifically to provide the high build required for static windings and the high mechanical strength required for rotating components.

QUALITY ASSURANCE

Generators are manufactured using production procedures having a quality assurance level to BS EN ISO 9001.

The stated voltage regulation may not be maintained in the presence of certain radio transmitted signals. Any change in performance will fall within the limits of Criteria 'B' of EN 61000-6-2:2001. At no time will the steady-state voltage regulation exceed 2%.

DE RATES

All values tabulated on page 8 are subject to the following reductions

5% when air inlet filters are fitted.

3% for every 500 metres by which the operating altitude exceeds 1000 metres above mean sea level.

3% for every 5 C by which the operational ambient temperature exceeds 50 C.

Note: Requirement for operating in an ambient exceeding 60 C must be referred to the factory.

NB Continuous development of our products entitles us to change specification details without notice, therefore they must not be regarded as binding.

Front cover drawing typical of product range.

APPROVED DOCUMENT

UCM224F

STAMFORD

WINDING 311 Single Phase

CONTROL SYSTEM	SEPARATELY EXCITED BY P.M.G.		
A.V.R.	MX321	MX341	
VOLTAGE REGULATION	± 0.5 %	± 1.0 %	With 4% ENGINE GOVERNING
SUSTAINED SHORT CIRCUIT	REFER TO SHORT CIRCUIT DECREMENT CURVES (page 7)		

INSULATION SYSTEM	CLASS H
PROTECTION	IP23
RATED POWER FACTOR	0.8
STATOR WINDING	DOUBLE LAYER CONCENTRIC
WINDING PITCH	TWO THIRDS
WINDING LEADS	12
STATOR WDG. RESISTANCE	0.043 Ohms AT 22°C DOUBLE DELTA CONNECTED
ROTOR WDG. RESISTANCE	0.83 Ohms at 22°C
EXCITER STATOR RESISTANCE	20 Ohms at 22°C
EXCITER ROTOR RESISTANCE	0.078 Ohms PER PHASE AT 22°C
R.F.I. SUPPRESSION	BS EN 61000-6-2 & BS EN 61000-6-4, VDE 0875G, VDE 0875N. refer to factory for others
WAVEFORM DISTORTION	NO LOAD < 1.5% NON-DISTORTING BALANCED LINEAR LOAD < 5.0%
MAXIMUM OVERSPEED	2250 Rev/Min
BEARING DRIVE END	BALL. 6312-2RS (ISO)
BEARING NON-DRIVE END	BALL. 6309-2RS (ISO)

	1 BEARING			2 BEARING		
WEIGHT COMP. GENERATOR	337 kg			350 kg		
WEIGHT WOUND STATOR	120 kg			120 kg		
WEIGHT WOUND ROTOR	110.69 kg			102.32 kg		
WR ² INERTIA	0.6071 kgm ²			0.5754 kgm ²		
SHIPPING WEIGHTS in a crate	360 kg			371 kg		
PACKING CRATE SIZE	105 x 57 x 96 (cm)			105 x 57 x 96 (cm)		
	50 Hz			60 Hz		
TELEPHONE INTERFERENCE	THF<2%			TIF<50		
COOLING AIR	0.216 m ³ /sec 458 cfm			0.281 m ³ /sec 595 cfm		
VOLTAGE DOUBLE DELTA	220/110	230/115	240/120	220/110	230/115	240/120
VOLTAGE PARALLEL DELTA	110	115	120	110	115	120
KVA BASE RATING FOR REACTANCE VALUES	42	42	42	43	45.5	48.5
X _d DIR. AXIS SYNCHRONOUS	1.98	1.81	1.66	2.30	2.23	2.18
X' _d DIR. AXIS TRANSIENT	0.15	0.14	0.13	0.19	0.19	0.18
X'' _d DIR. AXIS SUBTRANSIENT	0.10	0.09	0.09	0.13	0.12	0.12
X _q QUAD. AXIS REACTANCE	0.91	0.83	0.76	1.06	1.03	1.00
X'' _q QUAD. AXIS SUBTRANSIENT	0.13	0.12	0.11	0.12	0.12	0.11
X _L LEAKAGE REACTANCE	0.06	0.06	0.05	0.07	0.07	0.07
X ₂ NEGATIVE SEQUENCE	0.12	0.11	0.10	0.12	0.12	0.11
X ₀ ZERO SEQUENCE	0.09	0.08	0.08	0.09	0.09	0.09

REACTANCES ARE SATURATED

VALUES ARE PER UNIT AT RATING AND VOLTAGE INDICATED

T' _d TRANSIENT TIME CONST.	0.03 s
T'' _d SUB-TRANSTIME CONST.	0.008 s
T' _{do} O.C. FIELD TIME CONST.	0.75 s
T _a ARMATURE TIME CONST.	0.0065 s
SHORT CIRCUIT RATIO	1/X _d

50
Hz

STAMFORD

UCM224F
Winding 311 Single Phase

SINGLE PHASE EFFICIENCY CURVES

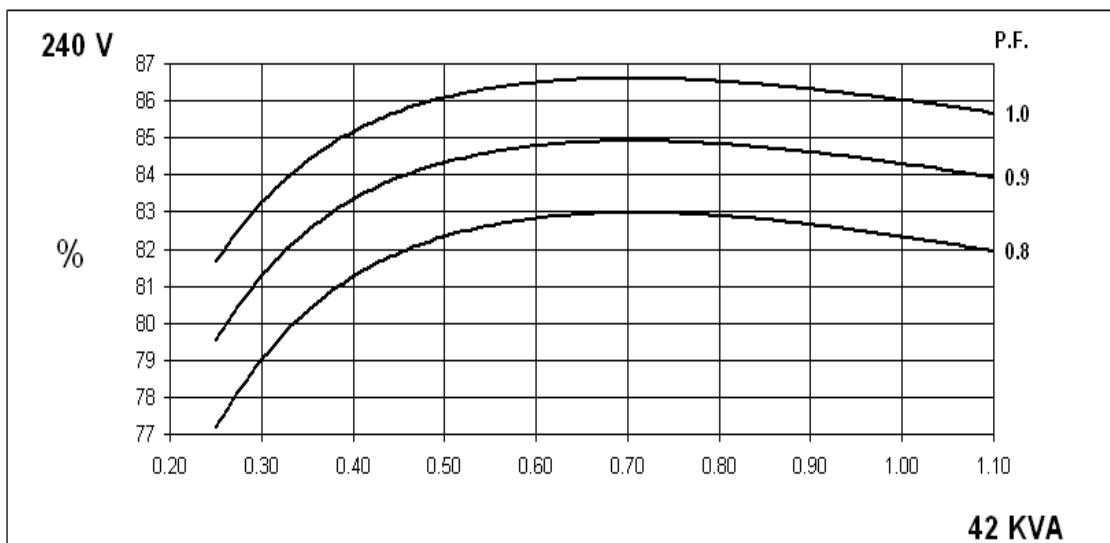
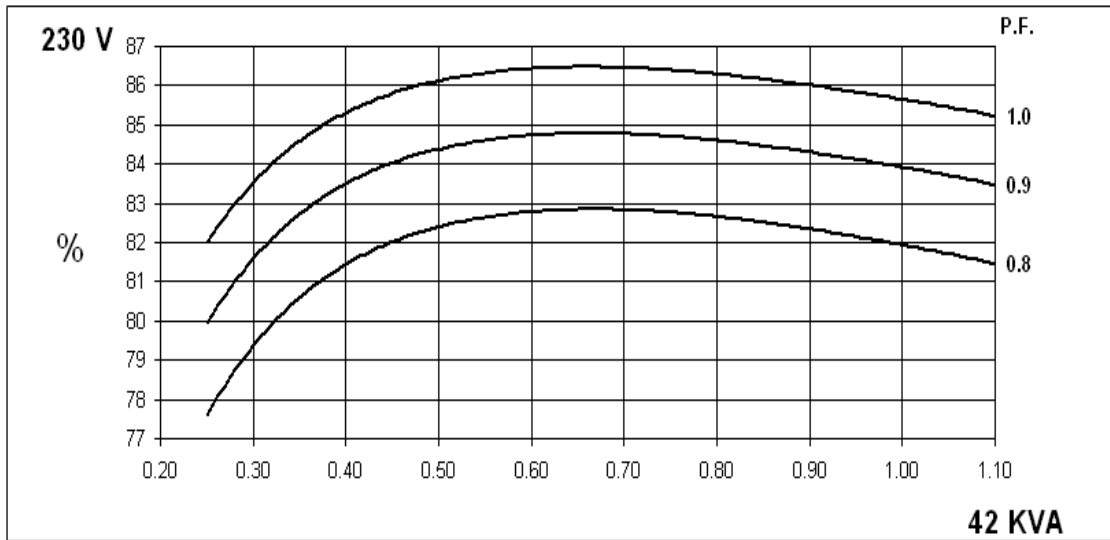
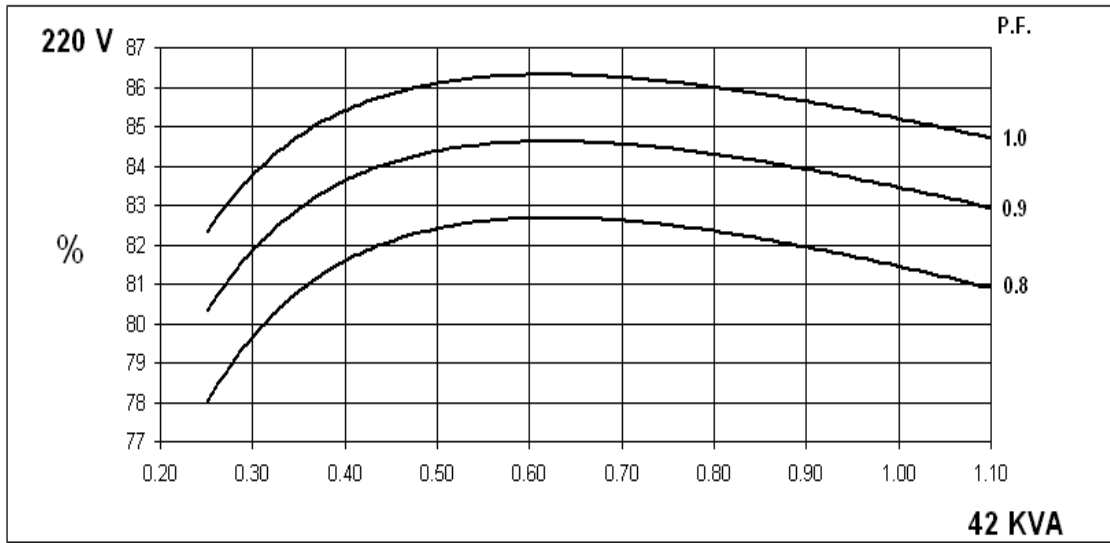

60
Hz

STAMFORD

UCM224F
Winding 311 Single Phase

SINGLE PHASE EFFICIENCY CURVES

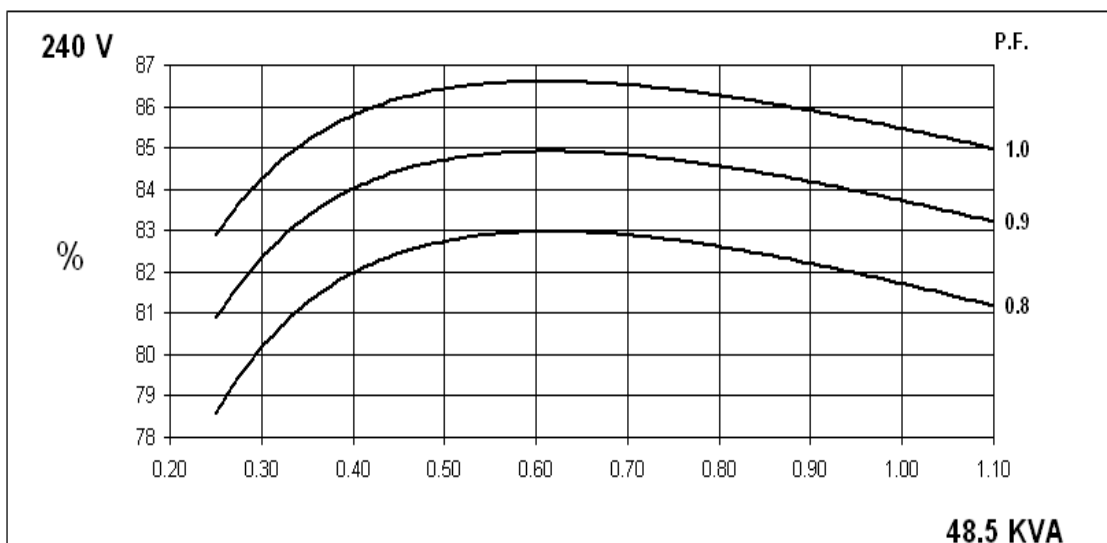
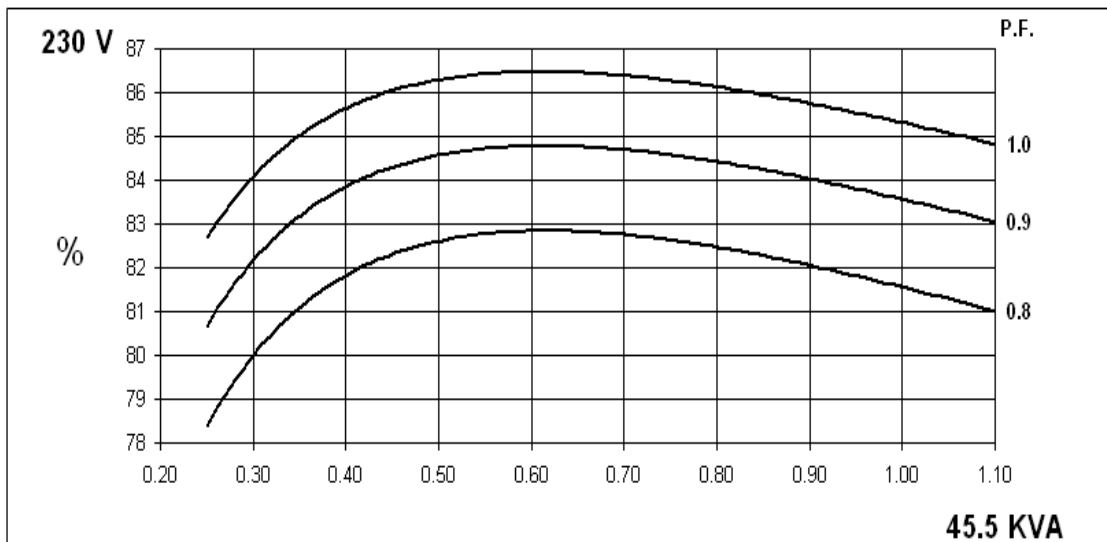
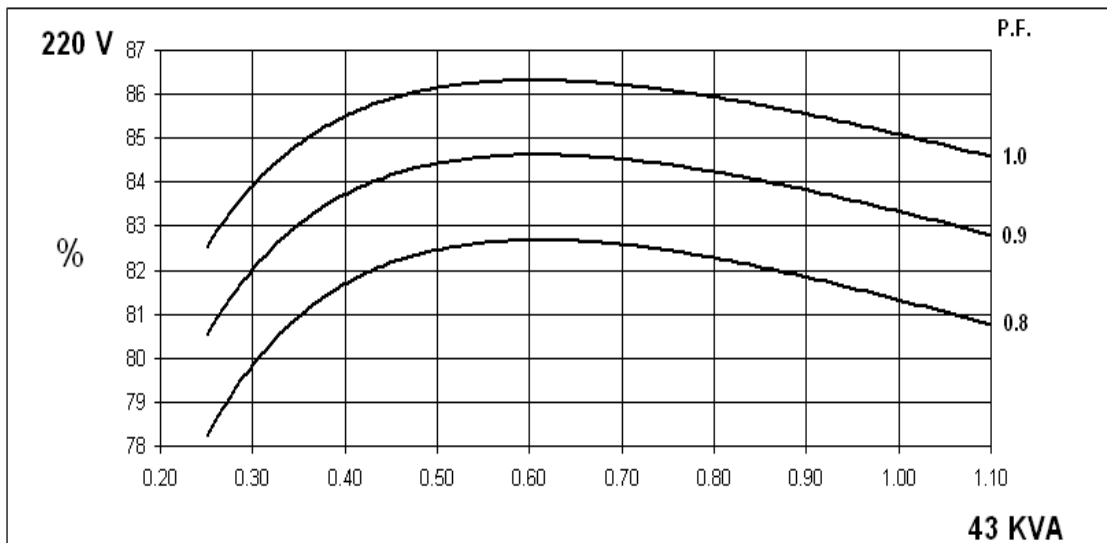

UCM224F

Winding 311 Single Phase

Locked Rotor Motor Starting Curve

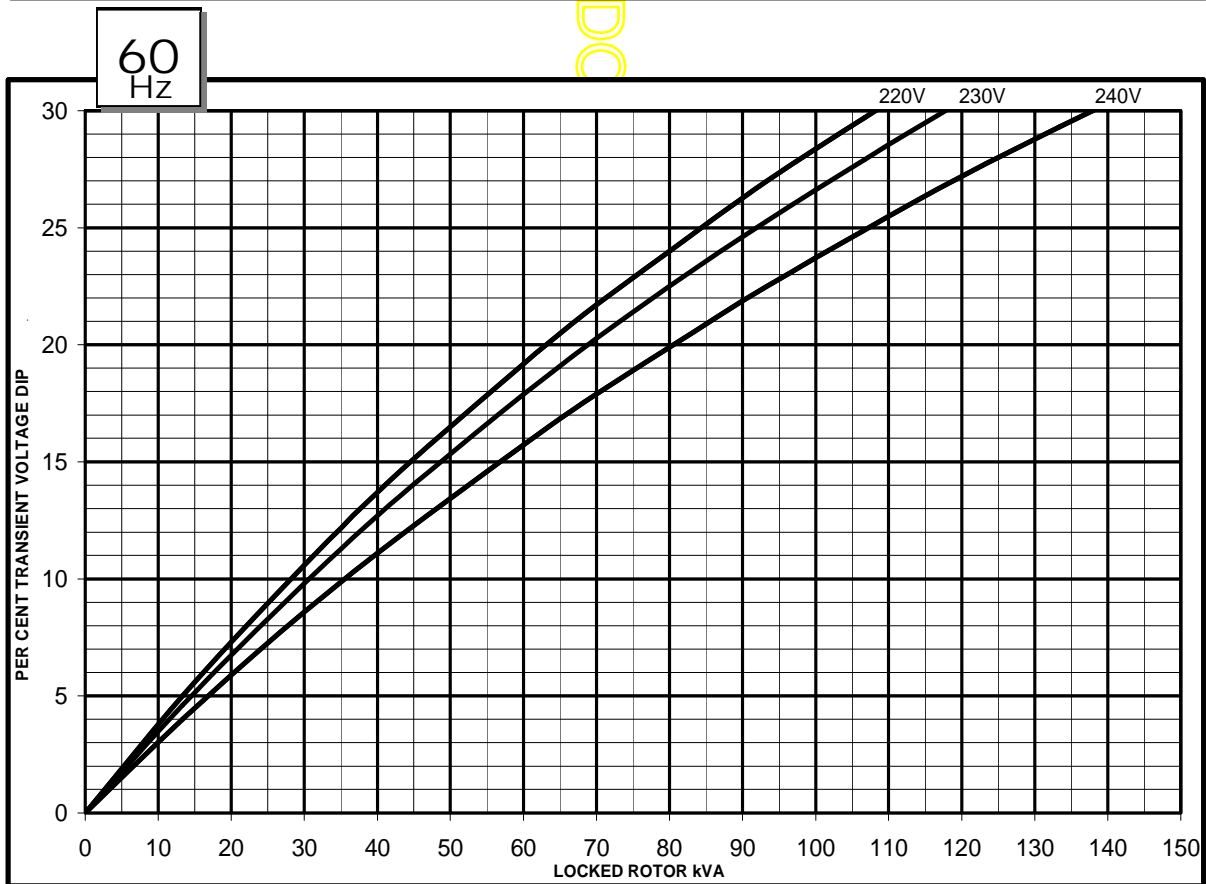
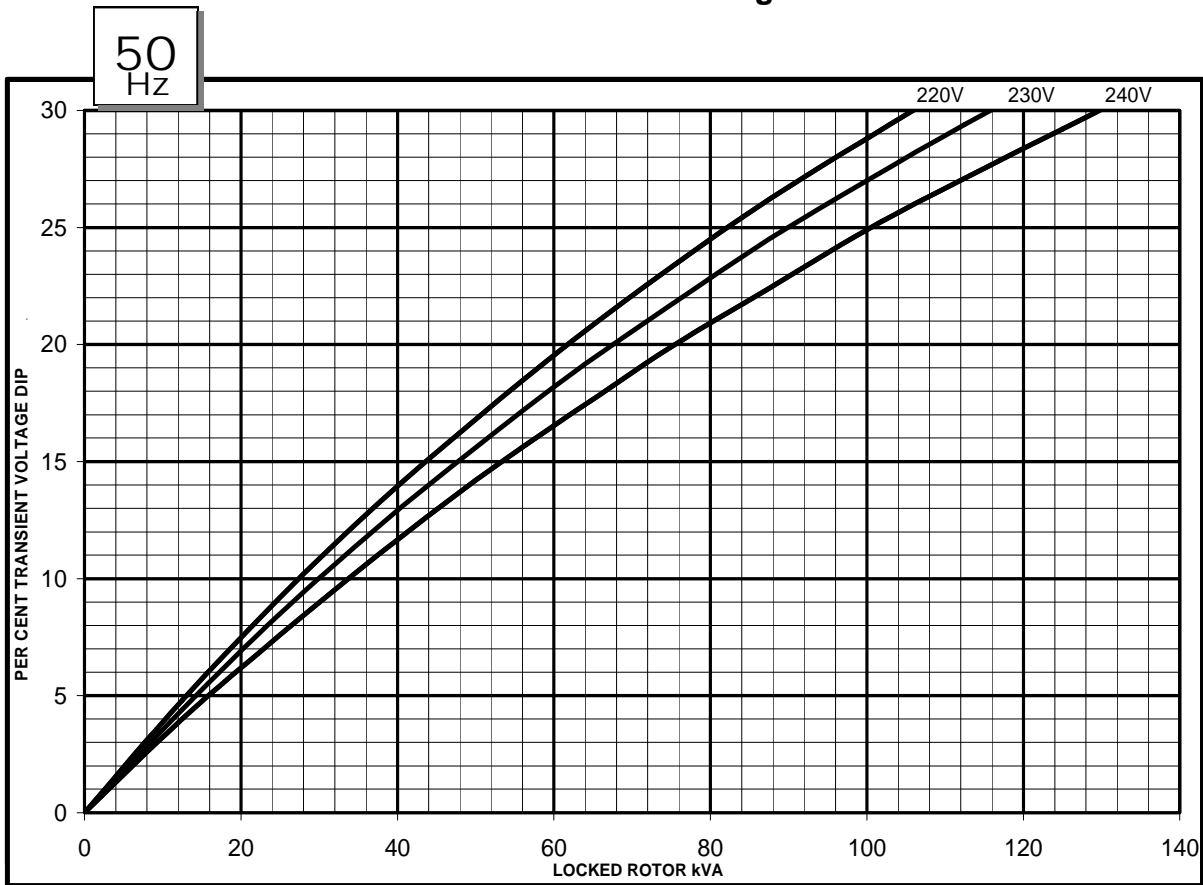

UCM224F



Winding 311 Single Phase

Single Phase Short Circuit Decrement Curve. No-load Excitation at Rated Speed Based on Double Delta connection.

50 Hz

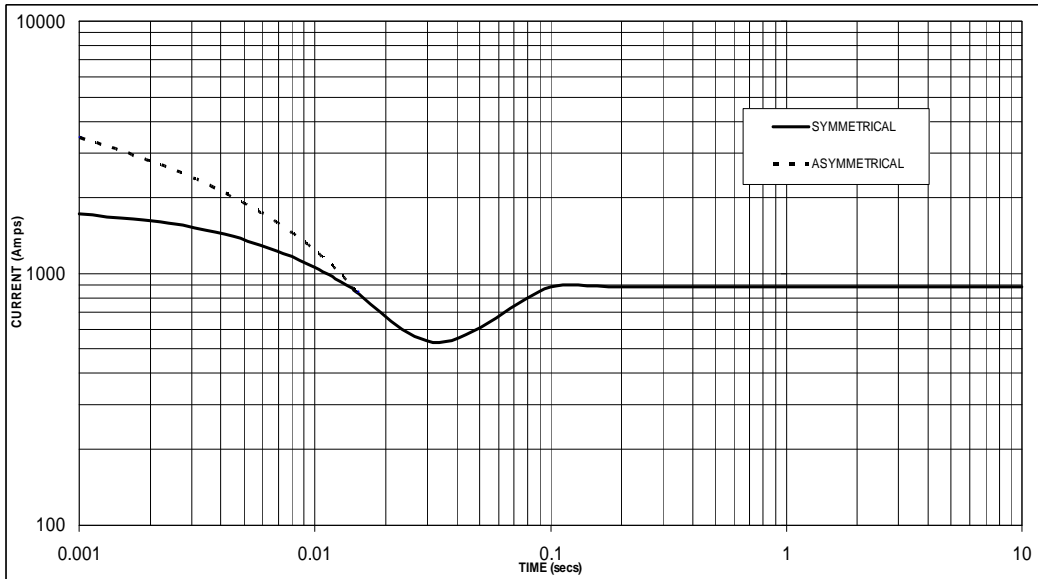

Sustained Short Circuit = 880 Amps

60 Hz

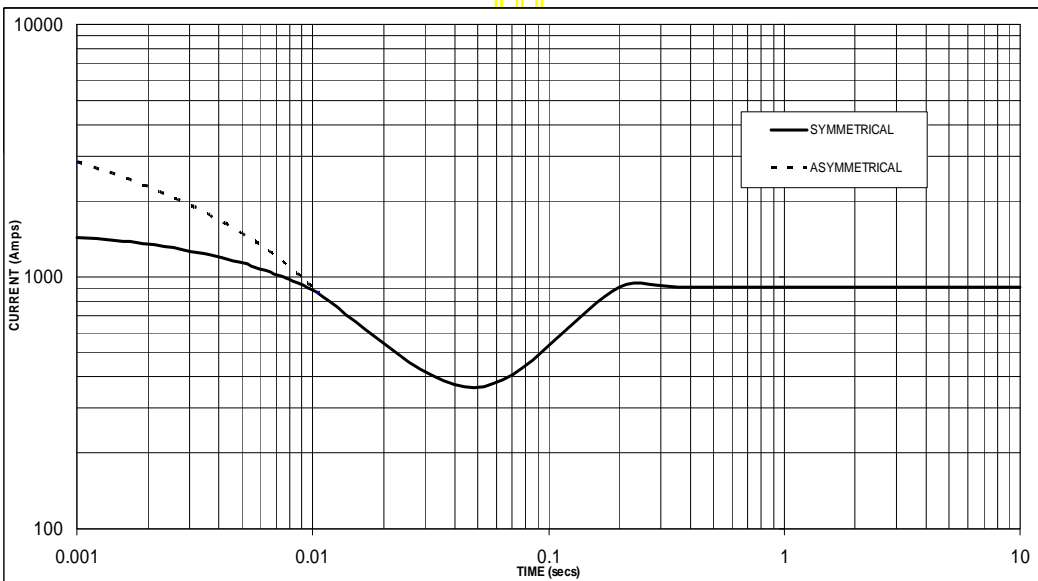

Sustained Short Circuit = 910 Amps

Note

The following multiplication factors should be used to adjust the values from curve between time 0.001 seconds and the minimum current point in respect of nominal operating voltage :

Voltage	Factor
220V	X 1.00
230V	X 1.05
240V	X 1.09

The sustained current value is constant irrespective of voltage level

Winding 311 Single Phase

RATINGS

50Hz

Class - Temp Rise	Cont. E - 65/50°C 0.8pf			Cont. B - 70/50°C 0.8pf			Cont. F - 90/50°C 0.8pf			Cont. H - 110/50°C 0.8pf		
Double Delta (V)	220	230	240	220	230	240	220	230	240	220	230	240
Parallel Delta (V)	110	115	120	110	115	120	110	115	120	110	115	120
kVA	32.3	32.3	32.3	33.5	33.5	33.5	38.5	38.5	38.5	42.0	42.0	42.0
kW	25.8	25.8	25.8	26.8	26.8	26.8	30.8	30.8	30.8	33.6	33.6	33.6
Efficiency (%)	82.5	82.6	82.7	82.4	82.6	82.7	81.9	82.2	82.4	81.6	81.9	82.2
kW Input	31.3	31.2	31.2	32.5	32.4	32.4	37.6	37.5	37.4	41.2	41.0	40.9

Class - Temp Rise	Cont. E - 65/50°C 1.0pf			Cont. B - 70/50°C 1.0pf			Cont. F - 90/50°C 1.0pf			Cont. H - 110/50°C 1.0pf		
Double Delta (V)	220	230	240	220	230	240	220	230	240	220	230	240
Parallel Delta (V)	110	115	120	110	115	120	110	115	120	110	115	120
kVA	32.3	32.3	32.3	33.5	33.5	33.5	38.5	38.5	38.5	42.0	42.0	42.0
kW	32.3	32.3	32.3	33.5	33.5	33.5	38.5	38.5	38.5	42.0	42.0	42.0
Efficiency (%)	86.4	86.5	86.6	86.3	85.6	86.6	85.9	86.1	86.4	85.5	85.9	86.1
kW Input	37.4	37.3	37.3	38.8	39.1	38.7	44.8	44.7	44.6	49.1	48.9	48.8

60Hz

Class - Temp Rise	Cont. E - 65/50°C 0.8pf			Cont. B - 70/50°C 0.8pf			Cont. F - 90/50°C 0.8pf			Cont. H - 110/50°C 0.8pf		
Double Delta (V)	220	230	240	220	230	240	220	230	240	220	230	240
Parallel Delta (V)	110	115	120	110	115	120	110	115	120	110	115	120
kVA	33.0	34.5	36.9	34.0	35.5	38.1	39.0	41.0	43.8	43.0	45.5	48.5
kW	26.4	27.6	29.5	27.2	28.4	30.5	31.2	32.8	35.0	34.4	36.4	38.8
Efficiency (%)	82.3	82.6	82.7	82.3	82.5	82.6	81.8	82.0	82.2	81.3	81.6	81.7
kW Input	32.1	33.4	35.7	33.0	34.4	36.9	38.1	40.0	42.6	42.3	44.6	47.5

Class - Temp Rise	Cont. E - 65/50°C 1.0pf			Cont. B - 70/50°C 1.0pf			Cont. F - 90/50°C 1.0pf			Cont. H - 110/50°C 1.0pf		
Double Delta (V)	220	230	240	220	230	240	220	230	240	220	230	240
Parallel Delta (V)	110	115	120	110	115	120	110	115	120	110	115	120
kVA	33.0	34.5	36.9	34.0	35.5	38.1	39.0	41.0	43.8	43.0	45.5	48.5
kW	33.0	34.5	36.9	34.0	35.5	38.1	39.0	41.0	43.8	43.0	45.5	48.5
Efficiency (%)	86.0	86.2	86.3	85.9	86.1	86.3	85.5	85.7	85.9	85.1	85.3	85.5
kW Input	38.4	40.0	42.8	39.6	41.2	44.1	45.6	47.8	51.0	50.5	53.3	56.7

UCM224F

Winding 311 Single Phase

STAMFORD

DIMENSIONS

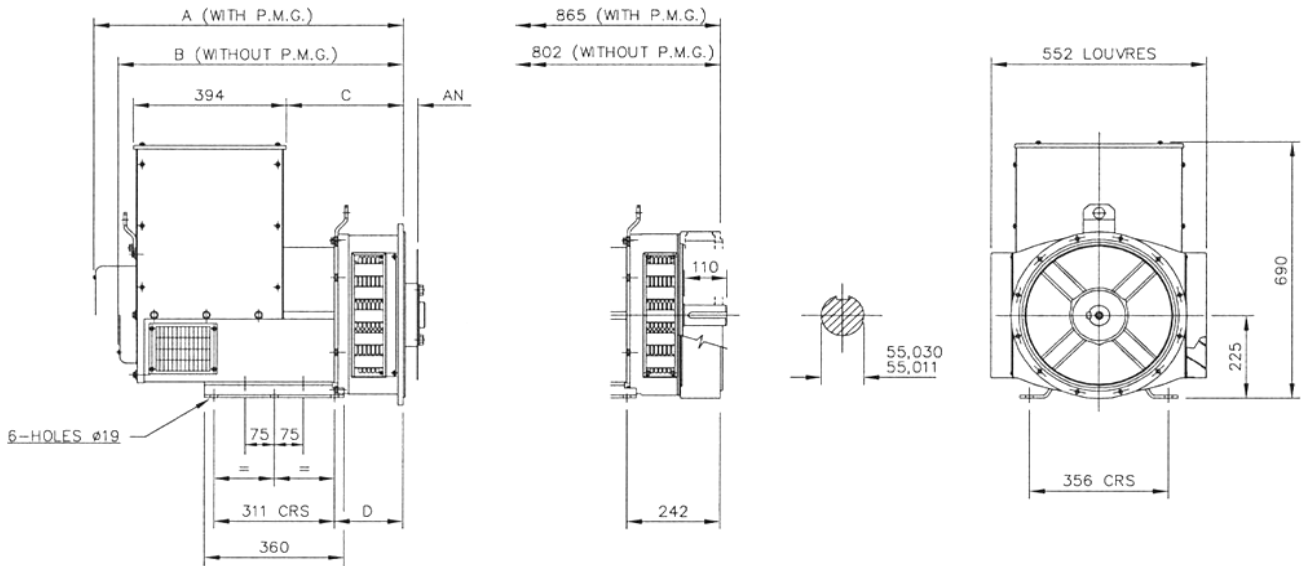

SINGLE BEARING ADAPTORS				
ADAPTOR	A	B	C	D
SAE 1	814,3	751,3	314,3	191,3
SAE 2	800	737	300	177
SAE 3	800	737	300	177
SAE 4	800	737	300	177

COUPLING DISCS	
DISC	AN
SAE 8	61,90
SAE 10	53,98
SAE 11,5	39,68
SAE 14	25,40

DOCUMENT

APPROVED DOCUMENT

STAMFORD

Head Office Address:
Barnack Road, Stamford
Lincolnshire, PE9 2NB
United Kingdom
Tel: +44 (0) 1780 484000
Fax: +44 (0) 1780 484100

www.cumminsgeneratortechnologies.com

Copyright 2010, Cummins Generator Technologies Ltd, All Rights Reserved
Stamford and AvK are registered trade marks of Cummins Generator Technologies Ltd
Cummins and the Cummins logo are registered trade marks of Cummins Inc.

