

STAMFORD®

S6L1M-F4 Wdg.311/312 - Technical Data Sheet

Standards

STAMFORD industrial alternators meet the requirements of the relevant parts of the IEC 60034 and the relevant sections of other international standards such as BS5000-3, ISO 8528-3, VDE 0530, NEMA MG1-32, CSA C22.2-100 and AS 60034. Other standards and certifications can be considered on request.

Quality Assurance

Alternators are manufactured using production procedures having a quality assurance level to BS EN ISO 9001.

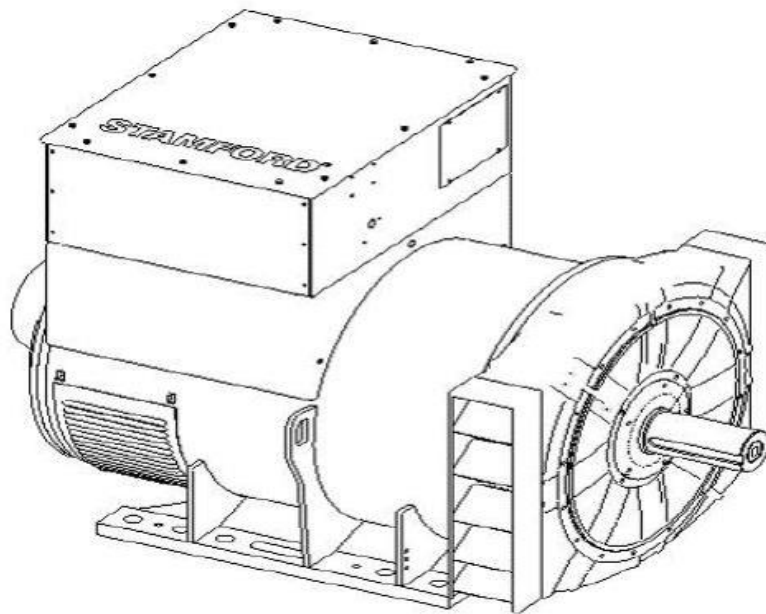

Excitation and Voltage Regulators

Excitation System					
AVR Type	MX341	MX321/MX322	DECS100	DECS150	
Voltage Regulation	± 1%	± 0.5%	± 0.25%	± 0.25%	with 4% Engine Governing
AVR Power	PMG	PMG	PMG	PMG	

No Load Excitation Voltage (V)	12.9 - 12.3
No Load Excitation Current (A)	0.68 - 0.55
Full Load Excitation Voltage (V)	53
Full Load Excitation Current (A)	2.6
Exciter Time Constant (seconds)	0.16

STAMFORD

S6L1M-F4 Wdg.311/312

Electrical Data								
Insulation System	H							
Stator Winding	Double Layer Concentric							
Winding Pitch	2/3							
Winding Leads	12/6							
Winding Number	311/312							
Number of Poles	4							
IP Rating	IP23							
RFI Suppression	BS EN 61000-6-2 & BS EN 61000-6-4, VDE 0875G, VDE 0875N. Refer to factory for others							
Waveform Distortion	NO LOAD < 1.5% NON-DISTORTING BALANCED LINEAR LOAD < 5.0%							
Short Circuit Ratio	1/Xd							
Steady State X/R Ratio	19.69							
	50 Hz				60 Hz			
Telephone Interference	THF<2%				TIF<50			
Cooling Air Flow	1.06 m³/sec				1.27 m³/sec			
Voltage Series Star (V)	380	400	415	440	416	440	460	480
Voltage Parallel Star (V)*	190	200	208	220	208	220	230	240
Voltage Delta (V)	220	230	240	254	240	254	266	277
kVA Base Rating (Class H) for Reactance Values (kVA)	930	950	970	970	1150	1200	1233	1270
Saturated Values in Per Unit at Base Ratings and Voltages								
Xd Dir. Axis Synchronous	2.19	2.02	1.91	1.70	2.71	2.53	2.37	2.25
X'd Dir. Axis Transient	0.13	0.12	0.11	0.10	0.16	0.15	0.14	0.13
X''d Dir. Axis Subtransient	0.10	0.10	0.09	0.08	0.13	0.12	0.11	0.11
Xq Quad. Axis Reactance	1.70	1.57	1.48	1.32	2.10	1.96	1.84	1.74
X''q Quad. Axis Subtransient	0.26	0.24	0.22	0.20	0.32	0.30	0.28	0.26
XL Stator Leakage Reactance	0.06	0.05	0.05	0.04	0.07	0.06	0.06	0.06
X2 Negative Sequence Reactance	0.15	0.14	0.13	0.12	0.19	0.18	0.17	0.16
X0 Zero Sequence Reactance	0.05	0.04	0.04	0.04	0.06	0.05	0.05	0.05
Unsaturated Values in Per Unit at Base Ratings and Voltages								
Xd Dir. Axis Synchronous	2.62	2.42	2.29	2.04	3.25	3.03	2.85	2.69
X'd Dir. Axis Transient	0.15	0.14	0.13	0.12	0.19	0.17	0.16	0.15
X''d Dir. Axis Subtransient	0.12	0.11	0.11	0.09	0.15	0.14	0.13	0.12
Xq Quad. Axis Reactance	1.75	1.61	1.53	1.36	2.17	2.02	1.90	1.80
X''q Quad. Axis Subtransient	0.31	0.28	0.27	0.24	0.38	0.36	0.33	0.32
XL Stator Leakage Reactance	0.06	0.06	0.05	0.05	0.08	0.07	0.07	0.06
Xlr Rotor Leakage Reactance	0.07	0.07	0.07	0.06	0.09	0.09	0.08	0.08
X2 Negative Sequence Reactance	0.18	0.17	0.16	0.14	0.23	0.21	0.20	0.19
X0 Zero Sequence Reactance	0.05	0.05	0.05	0.04	0.07	0.06	0.06	0.05

* Parallel Star connection only available with 12 leads winding option

STAMFORD

S6L1M-F4 Wdg.311/312

Time Constants (Seconds)		
T'd Transient Time Const.	0.097	
T''d Sub-Transient Time Const.	0.016	
T'do O.C. Field Time Const.	4.090	
Ta Armature Time Const.	0.022	
T''q Sub-Transient Time Const.	0.0110	
Resistances in Ohms (Ω) at 22°C		
Stator Winding Resistance (Ra), per phase for series connected	0.00180	
Rotor Winding Resistance (Rf)	2.13	
Exciter Stator Winding Resistance	19.56	
Exciter Rotor Winding Resistance per phase	0.095	
PMG Phase Resistance (Rpmg) per phase	1.91	
Positive Sequence Resistance (R1)	0.0023	
Negative Sequence Resistance (R2)	0.0026	
Zero Sequence Resistance (R0)	0.0023	
Saturation Factors	400V	480V
SG1.0	0.256	0.262
SG1.2	1.093	0.975
Mechanical Data		
Shaft and Keys	All alternator rotors are dynamically balanced to better than ISO 21940-11 Grade 2.5 for minimum vibration in operation. Two bearing generators are balanced with a half key.	
	1 Bearing	2 Bearing
SAE Adaptor	SAE0,1	SAE0,1
Moment of Inertia	23.475 kgm ²	22.95 kgm ²
Weight Wound Stator	1098kg	1098kg
Weight Wound Rotor	966kg	924kg
Weight Complete Alternator	2326kg	2269kg
Shipping weight in a Crate	2369kg	2312kg
Packing Crate Size	170x90x153(cm)	170x90x153(cm)
Maximum Over Speed	2250 RPM for two minutes	
Bearing Drive End	-	BALL 6224
Bearing Non-Drive End	BALL 6317	BALL 6317

STAMFORD

S6L1M-F4 Wdg.311/312

THREE PHASE EFFICIENCY CURVES

50Hz

60Hz

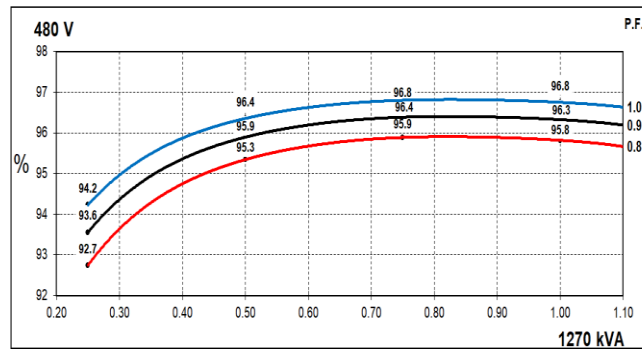
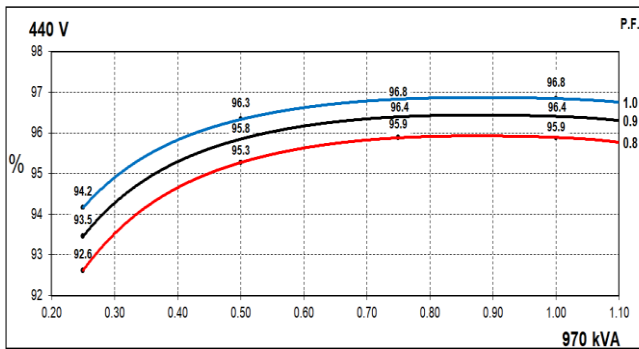
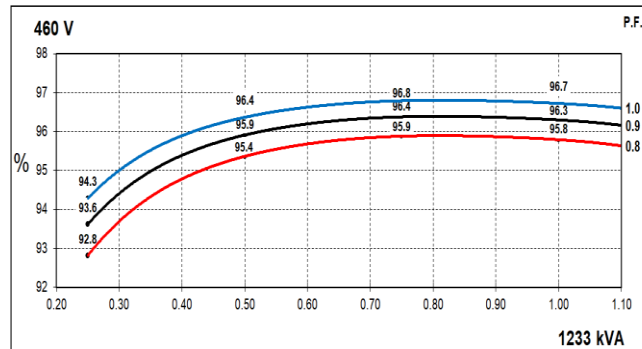
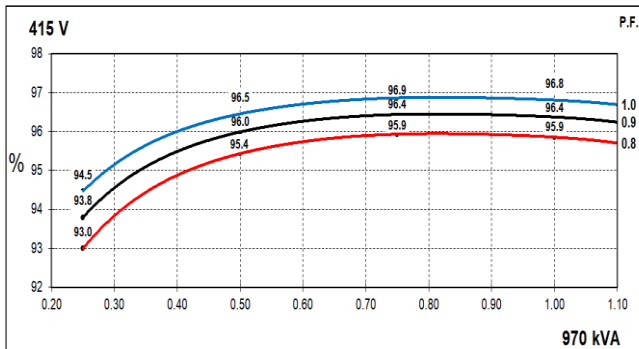
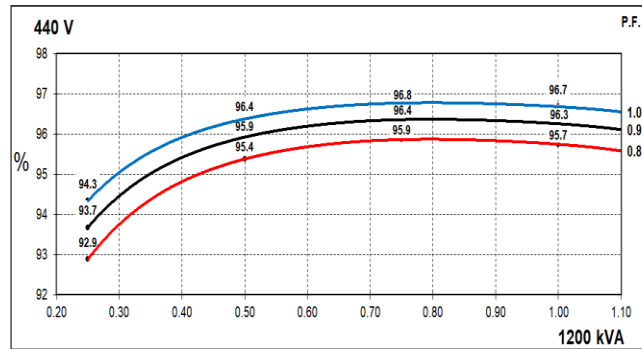
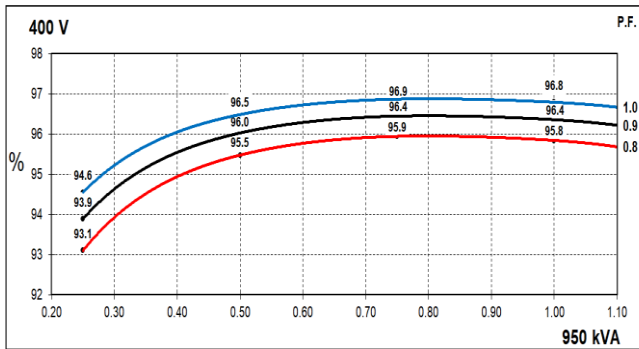
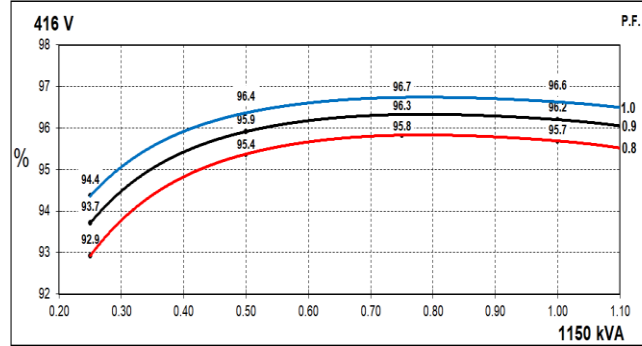
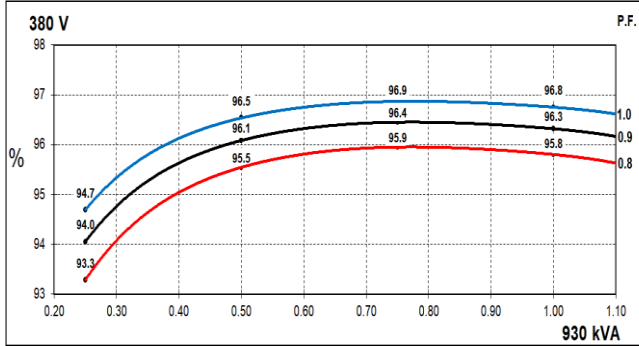

STAMFORD

S6L1M-F4 Wdg.311/312

Locked Rotor Motor Starting Curves - Separately Excited

50Hz

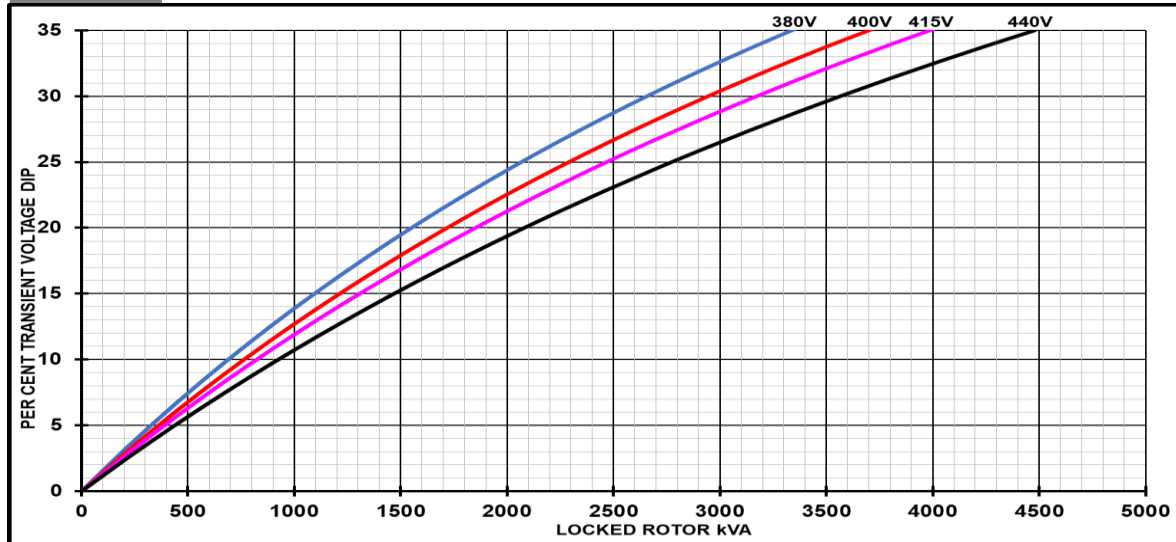

60Hz

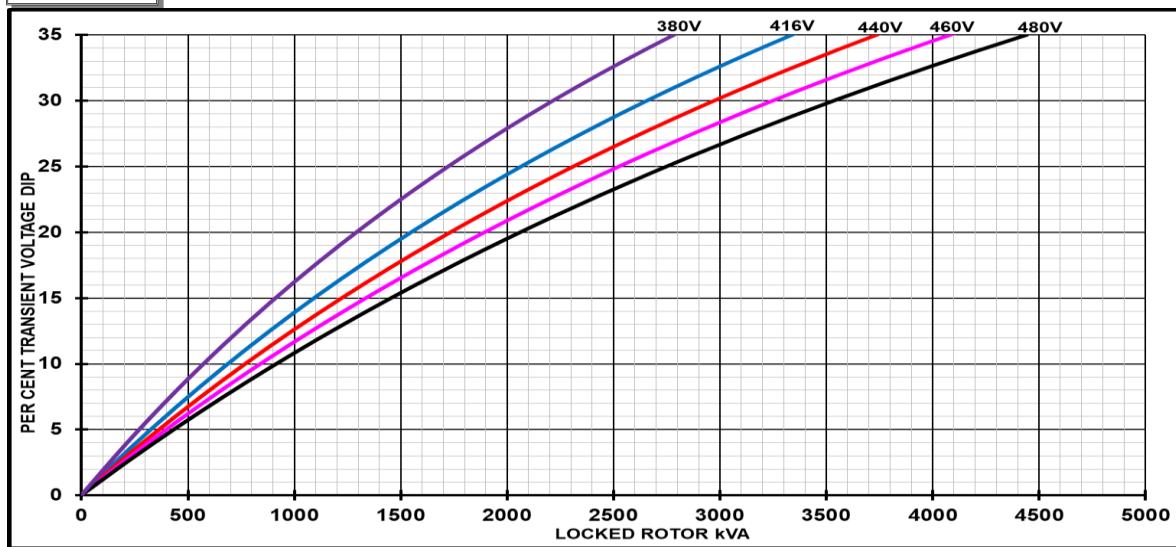

Transient Voltage Dip Scaling Factor		Transient Voltage Rise Scaling Factor	
Lagging PF	Scaling Factor	Lagging PF	Scaling Factor
<= 0.4	1.00	<= 0.4	1.25
0.5	0.95	0.5	1.20
0.6	0.90	0.6	1.15
0.7	0.86	0.7	1.10
0.8	0.83	> 0.7	1.00
0.9	0.75		
0.95	0.70		
1	0.65		

Note: To determine % Transient Voltage Dip or Voltage Rise at various PF, multiply the % Voltage Dip from the curve directly by the Scaling Factor.

STAMFORD®

S6L1M-F4 Wdg.311/312

Three-phase Short Circuit Decrement Curve - Separately Excited

50Hz

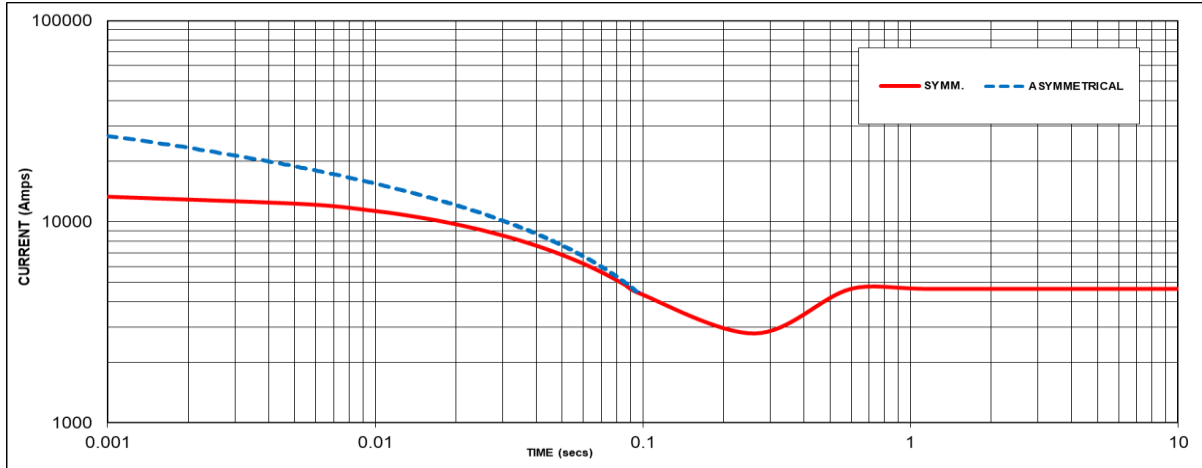

Sustained Short Circuit = 4650 Amps

60Hz

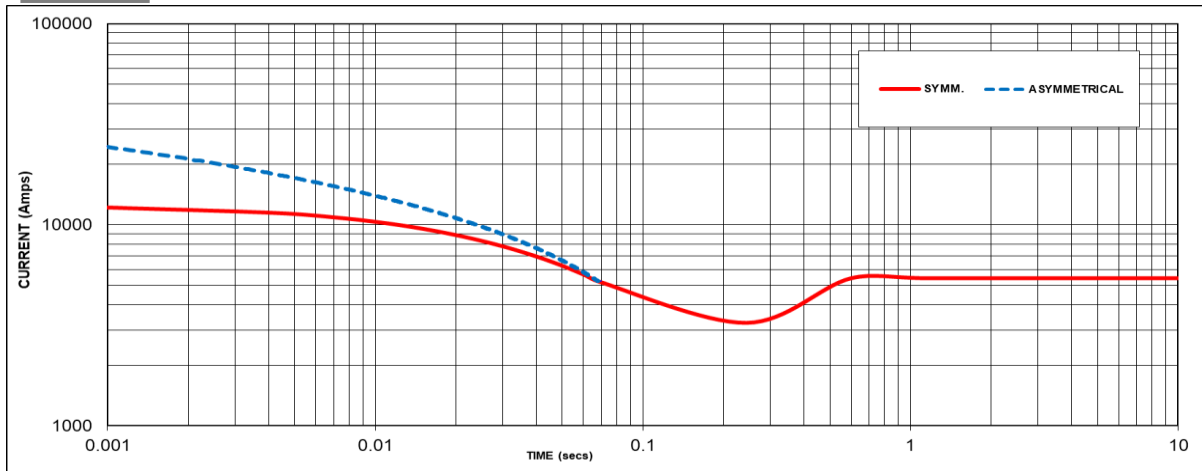

Sustained Short Circuit = 5420 Amps

Note 1

The following multiplication factors should be used to adjust the values from curve between time 0.001 seconds and the minimum current point in respect of nominal operating voltage :

50Hz		60Hz	
Voltage	Factor	Voltage	Factor
380V	X 1.00	416V	X 1.00
400V	X 1.05	440V	X 1.06
415V	X 1.09	460V	X 1.10
440V	X 1.16	480V	X 1.15

The sustained current value is constant irrespective of voltage level

If MX322 or digital AVR is used, the sustained short-circuit current value is to be multiplied by a factor of 1.1.

Note 2

The following multiplication factor should be used to convert the values calculated in accordance with NOTE 1 to those applicable to the various types of short circuit :

	3-phase	2-phase L-L	1-phase L-N
Instantaneous	x 1.00	x 0.87	x 1.30
Minimum	x 1.00	x 1.80	x 3.20
Sustained	x 1.00	x 1.50	x 2.50
Max. sustained duration	10 sec.	5 sec.	2 sec.

Note 3

All other times are unchanged
 Curves are drawn for Star connections under no-load excitation at rated speeds. For other connection (where applicable) the following multipliers should be applied to current values as shown :
 Parallel Star = Curve current value X 2
 Series Delta = Curve current value X 1.732

STAMFORD

S6L1M-F4 Wdg.311/312

Typical Alternator Operating Charts

400V/50Hz

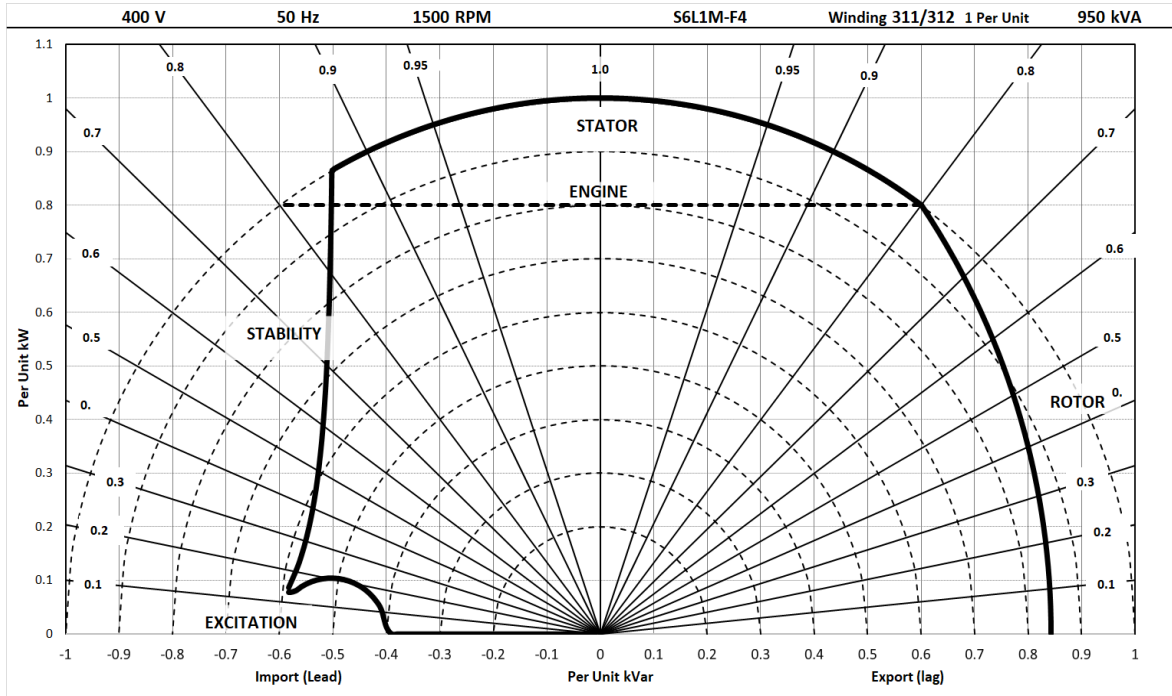

480V/60Hz

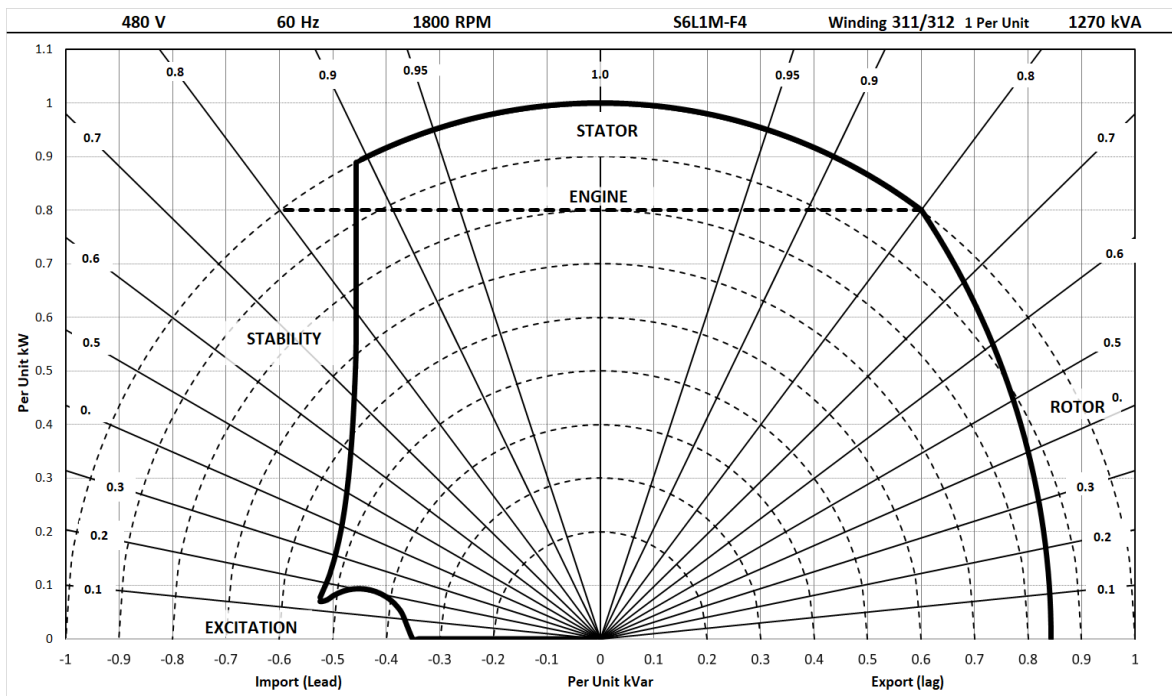

STAMFORD®

S6L1M-F4 Wdg.311/312

RATINGS AT 0.8 POWER FACTOR

Class - Temp Rise		Standby				Cont. H - 110/50°C				Cont. F - 90/50°C				Cont. B - 70/50°C			
50 Hz	Star (V)	380	400	415	440	380	400	415	440	380	400	415	440	380	400	415	440
	Parallel Star (V)*	190	200	208	220	190	200	208	220	190	200	208	220	190	200	208	220
	Delta (V)	220	230	240	254	220	230	240	254	220	230	240	254	220	230	240	254
	kVA	N/A	N/A	N/A	N/A	930	950	970	970	900	920	940	940	790	800	820	820
	kW	N/A	N/A	N/A	N/A	744	760	776	776	720	736	752	752	632	640	656	656
	Efficiency (%)	N/A	N/A	N/A	N/A	95.8	95.8	95.9	95.9	95.8	95.9	95.9	95.9	95.9	96.0	96.0	95.9
	kW Input	N/A	N/A	N/A	N/A	777	793	810	809	751	768	784	784	659	667	684	684

60 Hz	Star (V)	416	440	460	480	416	440	460	480	416	440	460	480	416	440	460	480
	Parallel Star (V)*	208	220	230	240	208	220	230	240	208	220	230	240	208	220	230	240
	Delta (V)	240	254	266	277	240	254	266	277	240	254	266	277	240	254	266	277
	kVA	N/A	N/A	N/A	N/A	1150	1200	1233	1270	1063	1113	1150	1150	925	965	1000	1010
	kW	N/A	N/A	N/A	N/A	920	960	986	1016	850	890	920	920	740	772	800	808
	Efficiency (%)	N/A	N/A	N/A	N/A	95.7	95.7	95.8	95.8	95.8	95.8	95.9	95.9	95.8	95.9	95.9	95.9
	kW Input	N/A	N/A	N/A	N/A	961	1003	1030	1060	888	929	960	959	772	805	834	842

* Parallel Star connection only available with 12 leads winding option

De-rates

All values tabulated above are subject to the following reductions:

- 5% when air inlet filters are fitted
- 3% for every 500 meters by which the operating altitude exceeds 1000 meters above mean sea level
- 3% for every 5°C by which the operational ambient temperature exceeds 40°C @ Class H temperature rise (please refer to applications for ambient temperature de-rates at other temperature rise classes)
- For any other operating conditions impacting the cooling circuit please refer to applications

Note: Requirement for operating in an ambient exceeding 60°C and altitude exceeding 4000 meters (for <690V) or 1500 meters (for >690V) must be referred to applications.

Dimensional and Torsional Drawing

For dimensional and torsional information please refer to the alternator General Arrangement and rotor drawings available on our website (<http://stamford-avk.com/>)

Note: Continuous development of our products means that the information contained in our data sheets can change without notice, and specifications should always be confirmed with Cummins Generator Technologies prior to purchase.



Follow us @stamfordavk



Cummins Generator Technologies



View our videos at youtube.com/stamfordavk

stamford-avk.com

**For Applications Support:
applications@cummins.com**

**For Customer Service:
emea.service@cummins.com**

**For General Enquiries:
Stamford-avk@cummins.com**

Copyright 2020. Cummins Generator Technologies Ltd. All rights reserved.
Cummins and the Cummins logo are registered trade marks of Cummins Inc.
STAMFORD is a registered trade mark of Cummins Generator Technologies Ltd.

