

# STAMFORD® S7 WATER-COOLED RANGE

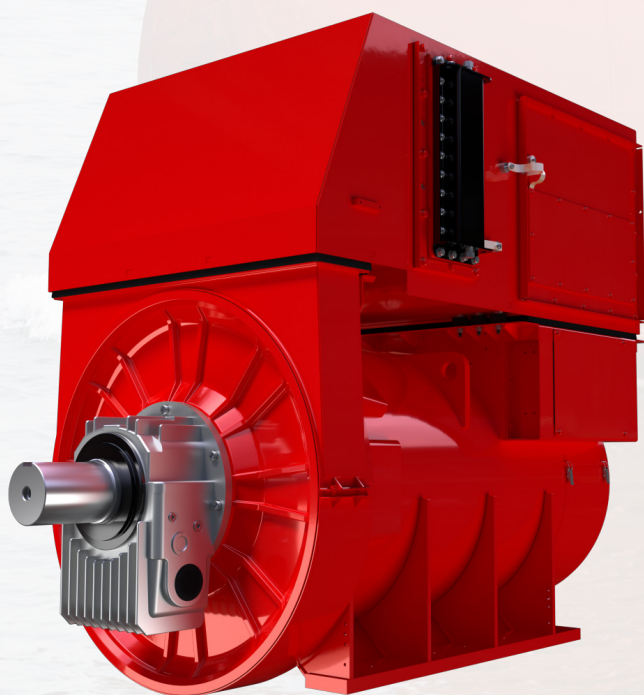

LOW VOLTAGE ALTERNATOR  
1425-2200 kVA 50 Hz  
1781-2644 kVA 60 Hz

**Flexibility | Uptime | Endurance**



## Driving innovation built on over 100 years of STAMFORD® and AvK® expertise.

The latest addition to the STAMFORD® S7 alternator range, now with water-cooling for marine and industrial applications. This product covers a wide power range from 1150 to 2644 kVA with a range of voltages from 380-690 V.

### FEATURES

- Water-cooled
- Anti-friction bearing
- Sleeve bearing option

### DESIGNED FOR ENDURANCE

- Class H insulation as standard for superior thermal life
- Anti-vibration mounts on water cooler for high reliability
- Validated at high ambient temperatures

### UPTIME MAXIMISED

- Flexibility of applications usage including PTO (Power Take Off) and PTI (Power Take in)
- Meets a wide range of marine classifications including IP23 to IP44 (IP54 Terminal box) and SOLAS
- Supports overload capability of 110% one hour in every twelve (as per ISO8528)
- 3 x short circuit current handling capability

### PEACE OF MIND

- World-class service network in over 120 countries with unmatched support
- 24 hours dedicated service support
- Global aftermarket network to support regular parts availability
- Class-leading 3 years warranty
- Authenticity guarantee - hologram verification

**STAMFORD | AvK™**

POWERING TOMORROW, TOGETHER

# S7LV marine ratings 380-480 V

4 pole alternator: 1500/1800 rpm (50 Hz/60 Hz)

## 50 Hz

Class B (70°C) temperature rise								
Volts	380		400		415		440	
Model	kW	kVA	kW	kVA	kW	kVA	kW	kVA
S7L1W-D	920	1150	952	1190	952	1190	932	1165
S7L1W-E	992	1240	1024	1280	1024	1280	1004	1255
S7L1W-F	1060	1325	1096	1370	1096	1370	1072	1340
S7L1W-J	1310	1638	1344	1680	1344	1680	1260	1575

Class F (90°C) temperature rise								
Volts	380		400		415		440	
Model	kW	kVA	kW	kVA	kW	kVA	kW	kVA
S7L1W-D	1004	1255	1056	1320	1076	1345	1056	1320
S7L1W-E	1056	1320	1096	1370	1096	1370	1088	1360
S7L1W-F	1092	1365	1148	1435	1192	1490	1216	1520
S7L1W-J	1542	1928	1584	1980	1584	1980	1460	1826

Class H (110°C) temperature rise								
Volts	380		400		415		440	
Model	kW	kVA	kW	kVA	kW	kVA	kW	kVA
S7L1W-D	1140	1425	1164	1455	1164	1455	1144	1430
S7L1W-E	1200	1500	1232	1540	1232	1540	1212	1515
S7L1W-F	1300	1625	1340	1675	1340	1675	1320	1650
S7L1W-J	1708	2135	1760	2200	1760	2200	1600	2000

\* Windings 312

Ratings are based on continuous, 50°C ambient  
 Ratings are based on a water inlet temperature of 38°C  
 Ratings are subject to change

## 60 Hz

Class B (70°C) temperature rise								
Volts	416		440		460		480	
Model	kW	kVA	kW	kVA	kW	kVA	kW	kVA
S7L1W-D	1045	1306	1115	1394	1140	1425	1160	1450
S7L1W-E	1096	1370	1160	1450	1220	1525	1260	1575
S7L1W-F	1195	1494	1275	1594	1300	1625	1325	1656
S7L1W-J	1450	1812	1530	1913	1600	2000	1670	2088

Class F (90°C) temperature rise								
Volts	416		440		460		480	
Model	kW	kVA	kW	kVA	kW	kVA	kW	kVA
S7L1W-D	1185	1481	1265	1581	1290	1612	1320	1650
S7L1W-E	1240	1550	1320	1650	1380	1725	1432	1790
S7L1W-F	1355	1694	1440	1800	1475	1844	1500	1875
S7L1W-J	1710	2137	1815	2269	1890	2363	1980	2475

Class H (110°C) temperature rise								
Volts	416		440		460		480	
Model	kW	kVA	kW	kVA	kW	kVA	kW	kVA
S7L1W-D	1290	1612	1365	1706	1390	1738	1425	1781
S7L1W-E	1300	1625	1370	1712	1430	1787	1500	1875
S7L1W-F	1425	1781	1560	1950	1590	1987	1620	2025
S7L1W-J	1830	2288	1940	2425	2025	2531	2115	2644

\* Windings 312

## STAMFORD® marine products



P0 / P1



UC22 / UC27

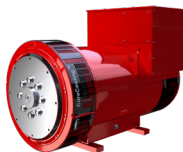

S4 / S5 / S6

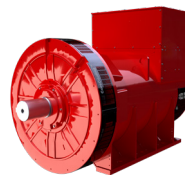

S7

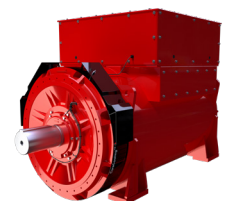

S9

7.5 kVA

5,000 kVA

# S7LV marine ratings 660-690 V

4 pole alternator: 1500/1800 rpm (50 Hz/60 Hz)

## 50 Hz

Class B (70°C) temperature rise				
Volts	660		690	
Model	kW	kVA	kW	kVA
S7L1W-D	960	1200	960	1200
S7L1W-E	992	1240	992	1240
S7L1W-F	1020	1275	1020	1275
S7L1W-J	1316	1645	1316	1645

Class F (90°C) temperature rise				
Volts	660		690	
Model	kW	kVA	kW	kVA
S7L1W-D	1076	1345	1076	1345
S7L1W-E	1088	1360	1088	1360
S7L1W-F	1152	1440	1152	1440
S7L1W-J	1556	1945	1556	1945

Class H (110°C) temperature rise				
Volts	660		690	
Model	kW	kVA	kW	kVA
S7L1W-D	1164	1455	1164	1455
S7L1W-E	1165	1456	1208	1510
S7L1W-F	1263	1579	1312	1640
S7L1W-J	1728	2160	1728	2160

## 60 Hz

Class B (70°C) temperature rise				
Volts	660		690	
Model	kW	kVA	kW	kVA
S7L1W-D	1132	1415	1132	1415
S7L1W-E	1164	1455	1164	1455
S7L1W-F	1196	1495	1196	1495
S7L1W-J	1528	1910	1528	1910

Class F (90°C) temperature rise				
Volts	660		690	
Model	kW	kVA	kW	kVA
S7L1W-D	1268	1585	1268	1585
S7L1W-E	1280	1600	1280	1600
S7L1W-F	1352	1690	1352	1690
S7L1W-J	1808	2260	1808	2260

Class H (110°C) temperature rise				
Volts	660		690	
Model	kW	kVA	kW	kVA
S7L1W-D	1304	1630	1372	1715
S7L1W-E	1420	1775	1420	1775
S7L1W-F	1540	1925	1540	1925
S7L1W-J	2008	2510	2008	2510

\* Windings 26

Ratings are based on continuous, 50°C ambient  
Ratings are based on a water inlet temperature of 38°C  
Ratings are subject to change

\* Windings 28

## AvK® marine products

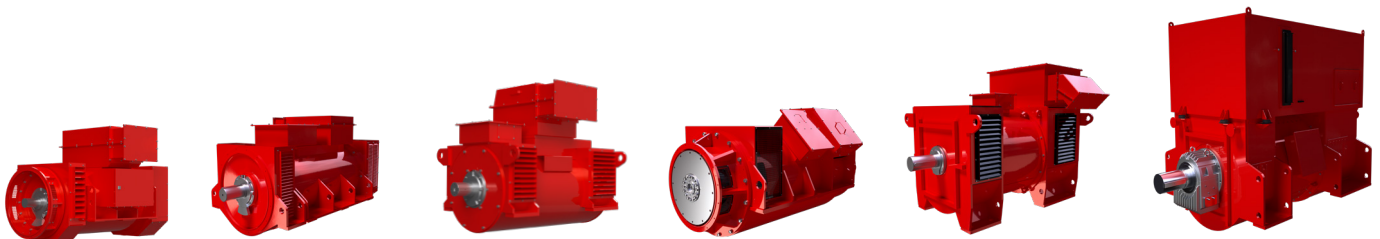

DSG 62

DSG 74

DSG 86

DSG 99

DSG 114

DSG 125

600 kVA

8,500 kVA

# Specifications

MODEL	S7LV marine
Ratings at 50 Hz (kVA) Class H	1425-2200
Ratings at 60 Hz (kVA) Class H	1612-2644
<b>Specifications</b>	
Voltage range	380-690 V
Poles	4
Technology	Wire Wound
AVR	MX322™
Voltage sensing	3 Phase
Bearing design	Anti-friction
Bearing arrangement	Double
Material insulation	Class H
Excitation system	PMG
Ingress protection	IP23 to IP44 (IP54 Terminal Box)
Connection with other machines	Paralleling capability
Cooling method	Water-cooled (IC81W)
<b>Optional features</b>	
Bearing design	Sleeve
SAE adaptors	SAE 0°, 00°, None
Flexible feet	✓

\*Adaptors to be provided on anti-friction bearing machines only. The standard S7 air-cooled marine machine product is also available with sleeve bearings (2 bearings only).

MX322™ includes	
Current sensing kit	✓
Controlled short circuit	✓
Manual voltage regulator	✓
Frequency detection module	✓
Power factor controller – PFC3	✓
Remote control interface	✓
Excitation circuit breaker	✓

## Accessories

Options
Quadrature droop kit
Anti-condensation heater
Winding RTDs and Thermistors (in another level)
Protection CTs
Remote voltage trimmer
Bearing RTD (each bearing)
Excitation loss module
Diode failure detector
Radio frequency interference (RFI) suppressor kit

STAMFORD® alternators meet the classification requirements of all major marine societies. Other certifications can be considered on request.

Prime movers	
Diesel engine	✓
Gas engine	✓

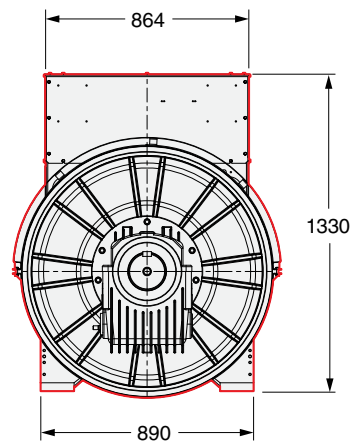
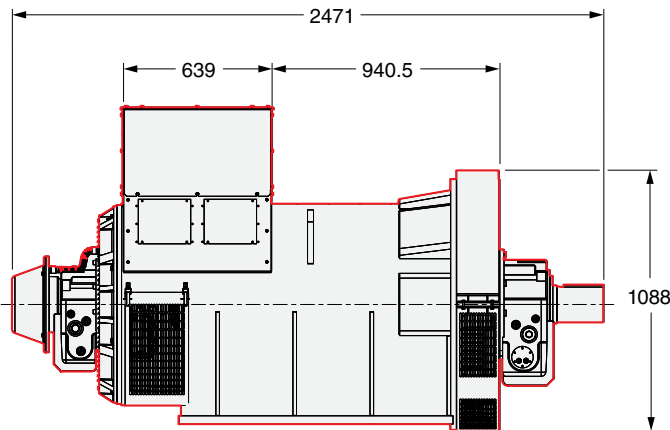

Full GA drawings available from <https://www.stamford-avk.com/downloads>



We are here to support your future decarbonisation goals, through our end-to-end expertise in versatile solutions. Backed by the reassurance of our world-renowned brands recognised for reliability and complete peace of mind, we are with you on your journey towards sustainability. [stamfordavk.li/future-ready](https://stamfordavk.li/future-ready)



**STAMFORD | AvK**™  
POWERING TOMORROW, TOGETHER



Copyright 2023, Cummins Generator Technologies Ltd. All rights reserved. Cummins and the Cummins logo are registered trade marks of Cummins Inc. STAMFORD and AvK are registered trademarks of Cummins Generator Technologies Ltd.

Part No. PB\_S7NEP\_EN/AF\_Rev.3