

# STAMFORD<sup>®</sup>

**HCM534D - Winding 311 Single Phase**

Technical Data Sheet

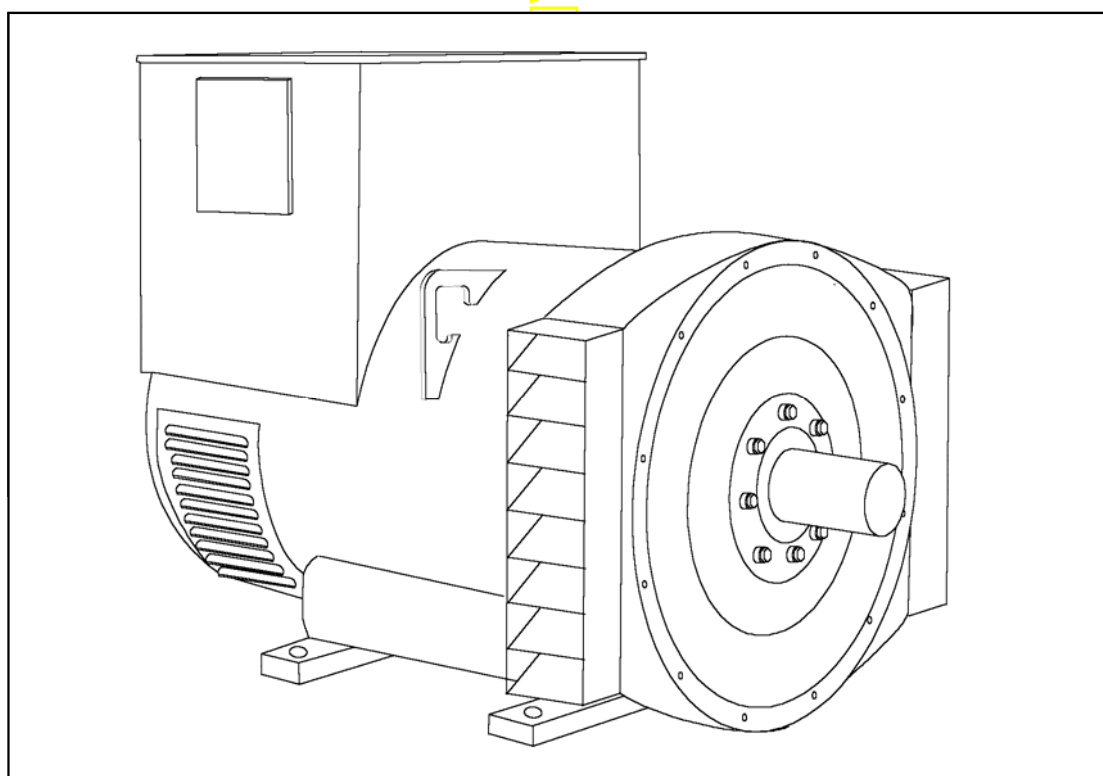

# HCM534D

## SPECIFICATIONS & OPTIONS

**STAMFORD**

### STANDARDS

Marine generators may be certified to Lloyds, DnV, Bureau Veritas, ABS, Germanischer-Lloyd or RINA. Other standards and certifications can be considered on request.

### VOLTAGE REGULATORS

#### MX341 AVR - STANDARD

This sophisticated Automatic Voltage Regulator (AVR) is incorporated into the Stamford Permanent Magnet Generator (PMG) control system, and is standard on marine generators of this type.

The PMG provides power via the AVR to the main exciter, giving a source of constant excitation power independent of generator output. The main exciter output is then fed to the main rotor, through a full wave bridge, protected by a surge suppressor. The AVR has in-built protection against sustained over-excitation, caused by internal or external faults. This de-excites the machine after a minimum of 5 seconds.

An engine relief load acceptance feature can enable full load to be applied to the generator in a single step.

If three-phase sensing is required with the PMG system the MX321 AVR must be used.

We recommend three-phase sensing for applications with greatly unbalanced or highly non-linear loads.

#### MX321 AVR

The most sophisticated of all our AVRs combines all the features of the MX341 with, additionally, three-phase rms sensing, for improved regulation and performance.

Over voltage protection is built-in and short circuit current level adjustments is an optional facility.

### WINDINGS & ELECTRICAL PERFORMANCE

All generator stators are wound to 2/3 pitch. This eliminates triplen (3rd, 9th, 15th ...) harmonics on the voltage waveform and is found to be the optimum design for trouble-free supply of non-linear loads. The 2/3 pitch design avoids excessive neutral currents sometimes seen with higher winding pitches, when in parallel with the mains. A fully connected damper winding reduces oscillations during paralleling. This winding, with the 2/3 pitch and carefully selected pole and tooth designs, ensures very low waveform distortion.

### TERMINALS & TERMINAL BOX

Standard generators are 3-phase reconnectable with 12 ends brought out to the terminals, which are mounted on a cover at the non-drive end of the generator. A sheet steel terminal box contains the AVR and provides ample space for the customers' wiring and gland arrangements. It has removable panels for easy access.

### SHAFT & KEYS

All generator rotors are dynamically balanced to better than BS6861:Part 1 Grade 2.5 for minimum vibration in operation. Two bearing generators are balanced with a half key.

### INSULATION/IMPREGNATION

The insulation system is class 'H'.

All wound components are impregnated with materials and processes designed specifically to provide the high build required for static windings and the high mechanical strength required for rotating components.

### QUALITY ASSURANCE

Generators are manufactured using production procedures having a quality assurance level to BS EN ISO 9001.

The stated voltage regulation may not be maintained in the presence of certain radio transmitted signals. Any change in performance will fall within the limits of Criteria 'B' of EN 61000-6-2:2001. At no time will the steady-state voltage regulation exceed 2%.

### DE RATES

All values tabulated on page 8 are subject to the following reductions

5% when air inlet filters are fitted.

3% for every 500 metres by which the operating altitude exceeds 1000 metres above mean sea level.

3% for every 5 C by which the operational ambient temperature exceeds 40 C.

Note: Requirement for operating in an ambient exceeding 60 C must be referred to the factory.

*NB Continuous development of our products entitles us to change specification details without notice, therefore they must not be regarded as binding.*

*Front cover drawing typical of product range.*

APPROVED DOCUMENT

# HCM534D

**STAMFORD**

## WINDING 311 Single Phase

CONTROL SYSTEM	SEPARATELY EXCITED BY P.M.G.					
A.V.R.	MX321	MX341				
VOLTAGE REGULATION	± 0.5 %	± 1.0 %	With 4% ENGINE GOVERNING			
SUSTAINED SHORT CIRCUIT	REFER TO SHORT CIRCUIT DECREMENT CURVES (page 7)					
INSULATION SYSTEM	CLASS H					
PROTECTION	IP23					
RATED POWER FACTOR	0.8					
STATOR WINDING	DOUBLE LAYER LAP					
WINDING PITCH	TWO THIRDS					
WINDING LEADS	12					
STATOR WDG. RESISTANCE	0.003 Ohms AT 22°C DOUBLE DELTA CONNECTED					
ROTOR WDG. RESISTANCE	1.77 Ohms at 22°C					
EXCITER STATOR RESISTANCE	17 Ohms at 22°C					
EXCITER ROTOR RESISTANCE	0.092 Ohms PER PHASE AT 22°C					
R.F.I. SUPPRESSION	BS EN 61000-6-2 & BS EN 61000-6-4, VDE 0875G, VDE 0875N. refer to factory for others					
WAVEFORM DISTORTION	NO LOAD < 1.5% NON-DISTORTING BALANCED LINEAR LOAD < 5.0%					
MAXIMUM OVERSPEED	2250 Rev/Min					
BEARING DRIVE END	BALL. 6220 (ISO)					
BEARING NON-DRIVE END	BALL. 6314 (ISO)					
	1 BEARING			2 BEARING		
WEIGHT COMP. GENERATOR	1393 kg			1395 kg		
WEIGHT WOUND STATOR	657 kg			657 kg		
WEIGHT WOUND ROTOR	563 kg			535 kg		
WR <sup>2</sup> INERTIA	8.0068 kgm <sup>2</sup>			7.7289 kgm <sup>2</sup>		
SHIPPING WEIGHTS in a crate	1485 kg			1485 kg		
PACKING CRATE SIZE	166 x 87 x 124(cm)			166 x 87 x 124(cm)		
	50 Hz			60 Hz		
TELEPHONE INTERFERENCE	THF<2%			TIF<50		
COOLING AIR	1.035 m <sup>3</sup> /sec 2202 cfm			1.312 m <sup>3</sup> /sec 2780 cfm		
VOLTAGE DOUBLE DELTA	220/110	230/115	240/120	220/110	230/115	240/120
VOLTAGE PARALLEL DELTA	110	115	120	110	115	120
KVA BASE RATING FOR REACTANCE VALUES	174	174	174	183	192	200
X <sub>d</sub> DIR. AXIS SYNCHRONOUS	1.56	1.43	1.31	1.99	1.91	1.83
X' <sub>d</sub> DIR. AXIS TRANSIENT	0.08	0.07	0.07	0.10	0.09	0.09
X'' <sub>d</sub> DIR. AXIS SUBTRANSIENT	0.06	0.05	0.05	0.07	0.07	0.06
X <sub>q</sub> QUAD. AXIS REACTANCE	1.29	1.18	1.08	1.62	1.56	1.49
X'' <sub>q</sub> QUAD. AXIS SUBTRANSIENT	0.14	0.13	0.12	0.18	0.17	0.16
X <sub>L</sub> LEAKAGE REACTANCE	0.02	0.02	0.02	0.03	0.03	0.03
X <sub>2</sub> NEGATIVE SEQUENCE	0.10	0.09	0.08	0.12	0.12	0.11
X <sub>0</sub> ZERO SEQUENCE	0.05	0.05	0.04	0.06	0.05	0.05
REACTANCES ARE SATURATED			VALUES ARE PER UNIT AT RATING AND VOLTAGE INDICATED			
T' <sub>d</sub> TRANSIENT TIME CONST.	0.08 s					
T'' <sub>d</sub> SUB-TRANSTIME CONST.	0.012 s					
T' <sub>do</sub> O.C. FIELD TIME CONST.	2.2 s					
T <sub>a</sub> ARMATURE TIME CONST.	0.018 s					
SHORT CIRCUIT RATIO	1/X <sub>d</sub>					

50  
Hz

HCM534D  
Winding 311 Single Phase

STAMFORD

SINGLE PHASE EFFICIENCY CURVES

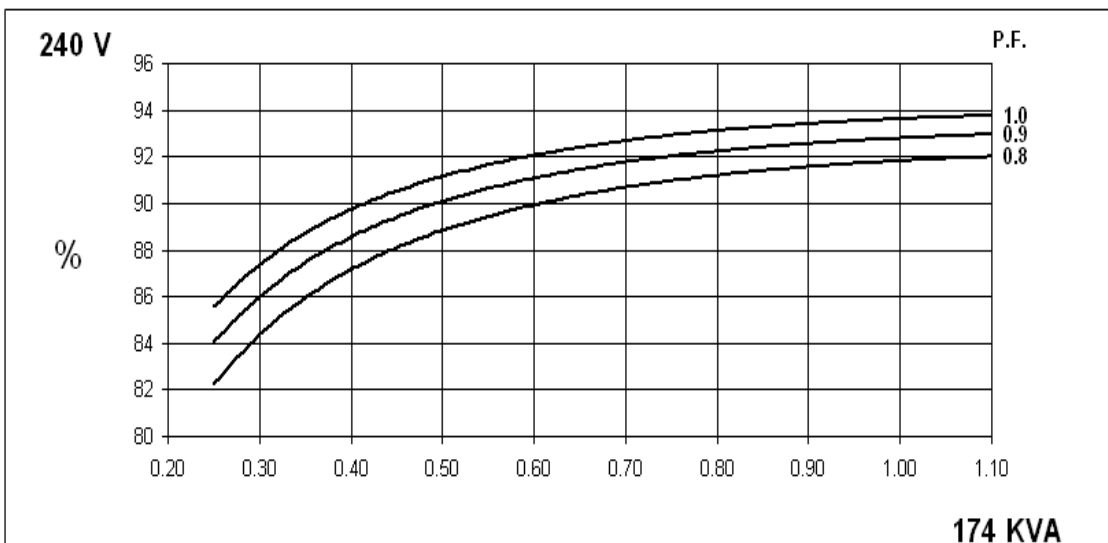
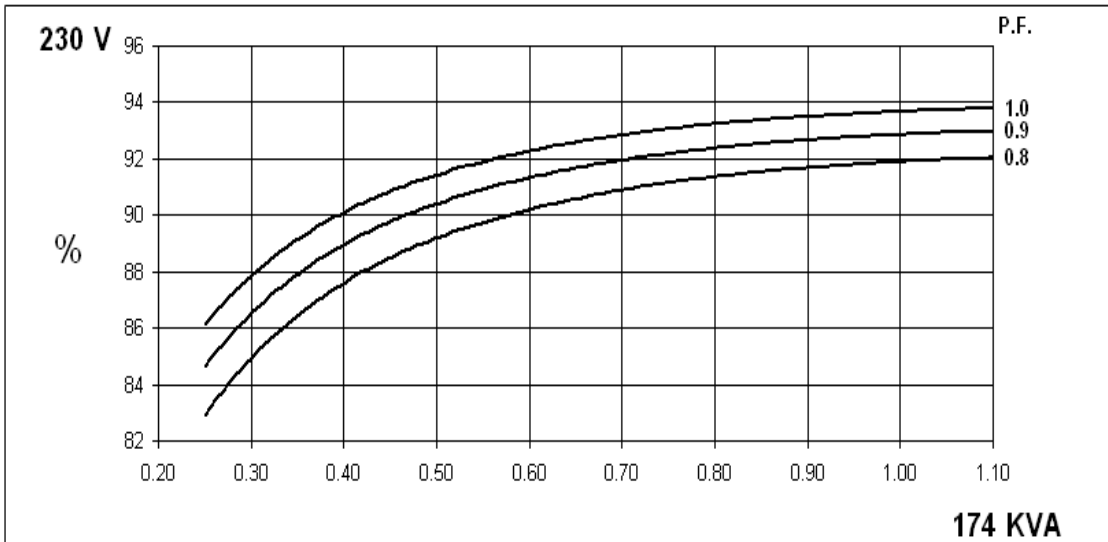
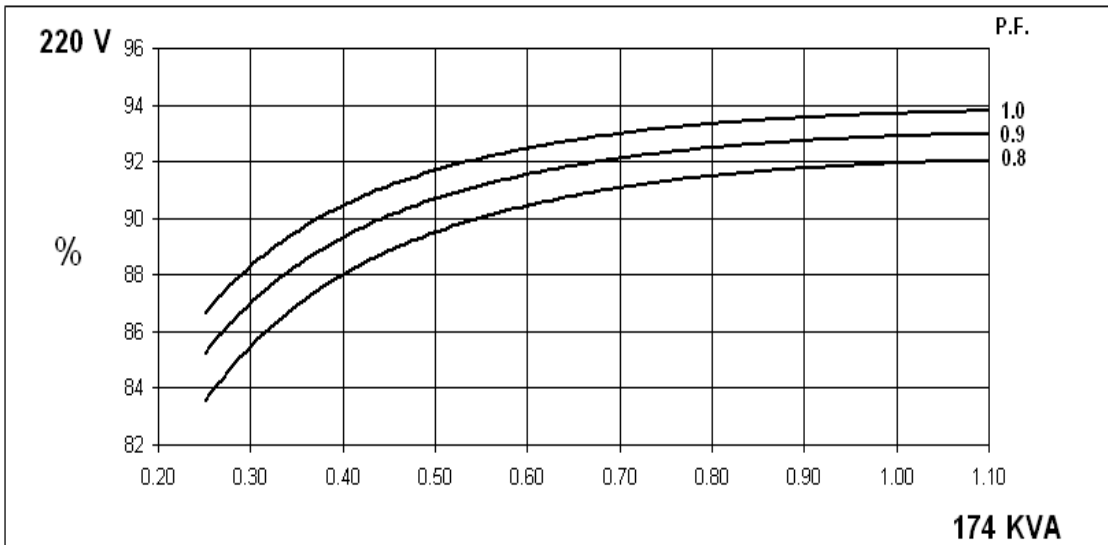

60  
Hz

HCM534D  
Winding 311 Single Phase

STAMFORD

SINGLE PHASE EFFICIENCY CURVES

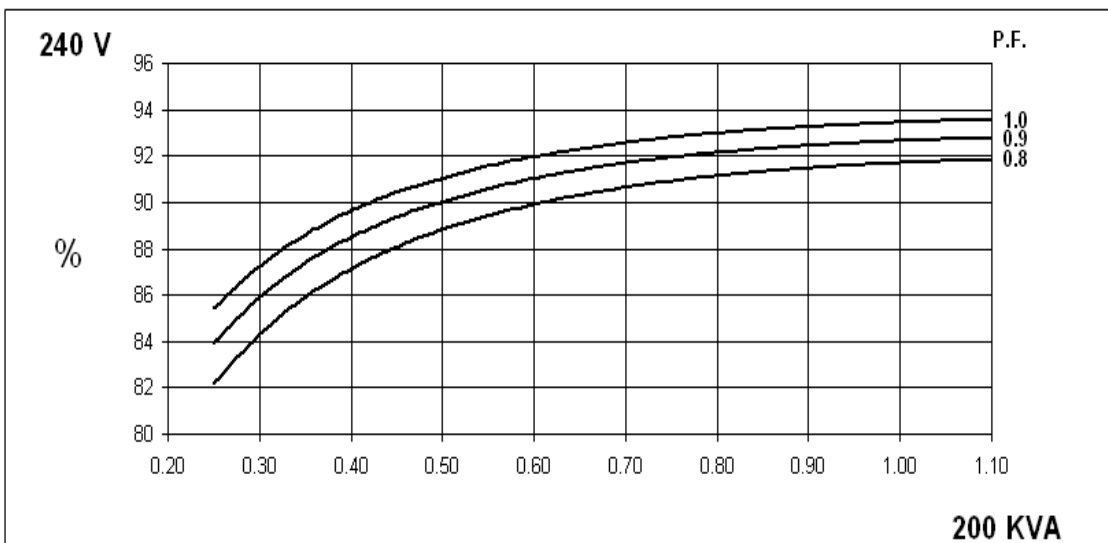
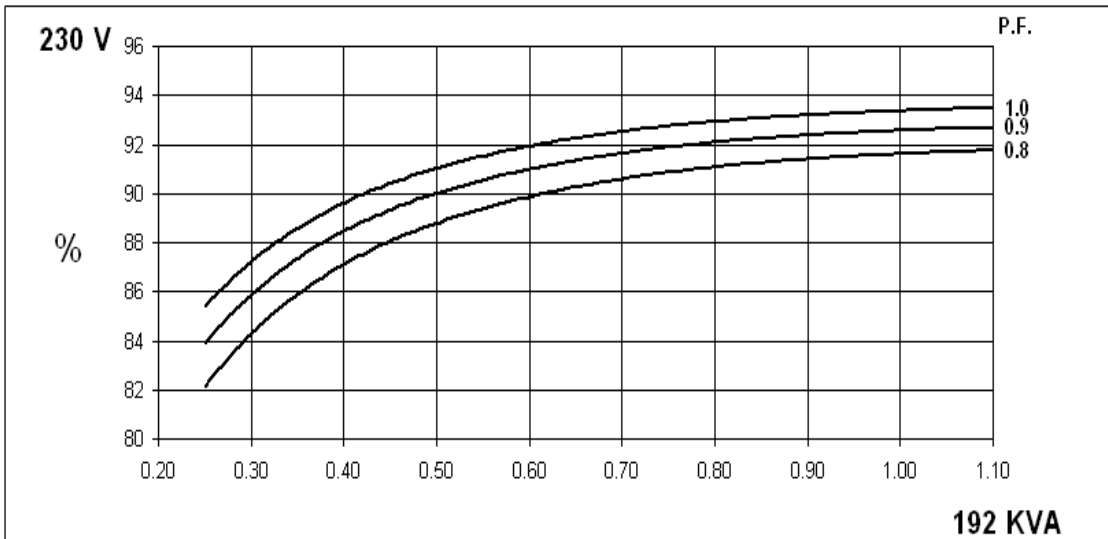
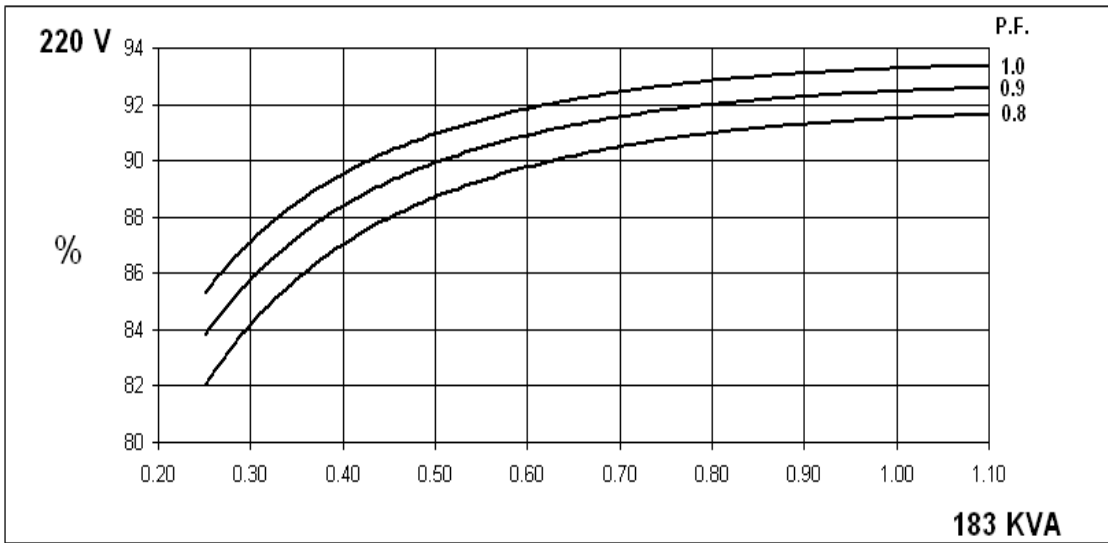

Winding 311 Single Phase

Locked Rotor Motor Starting Curve

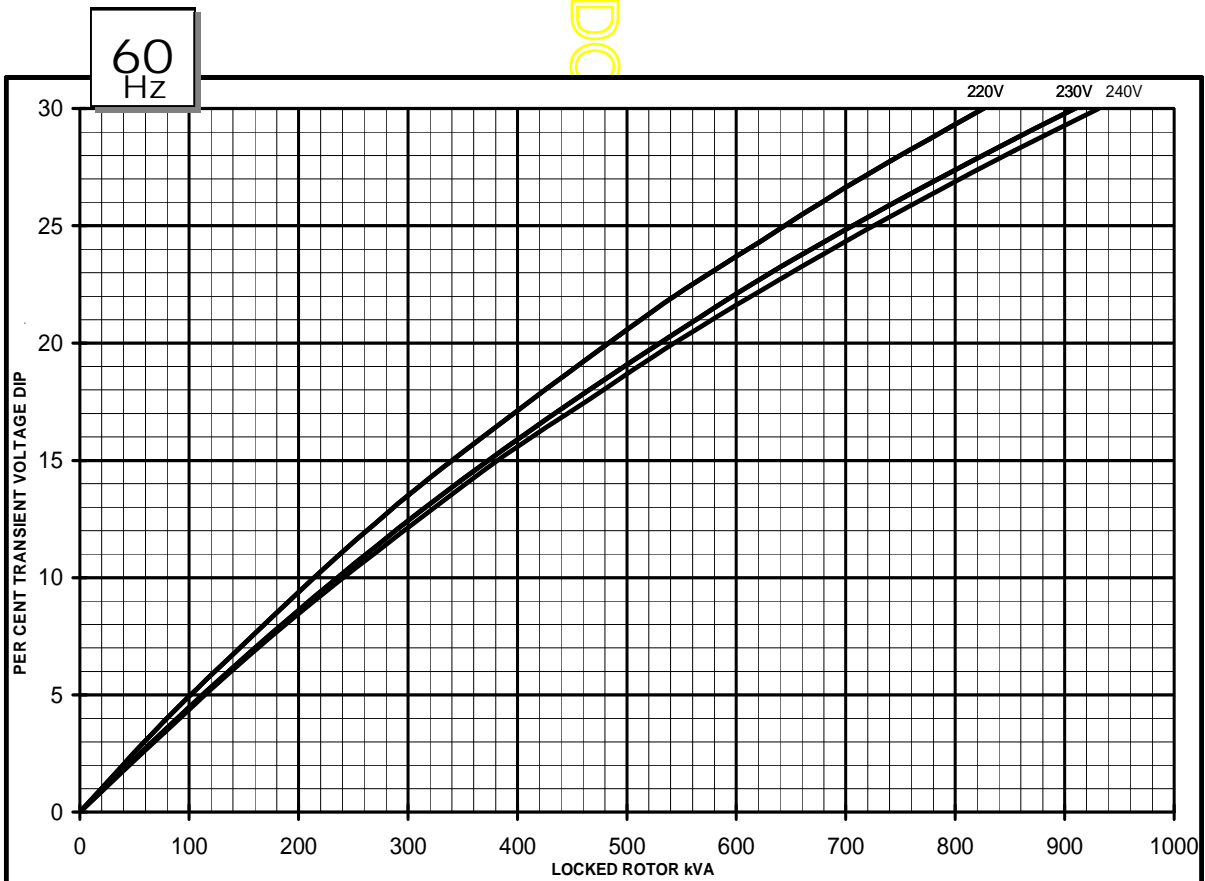
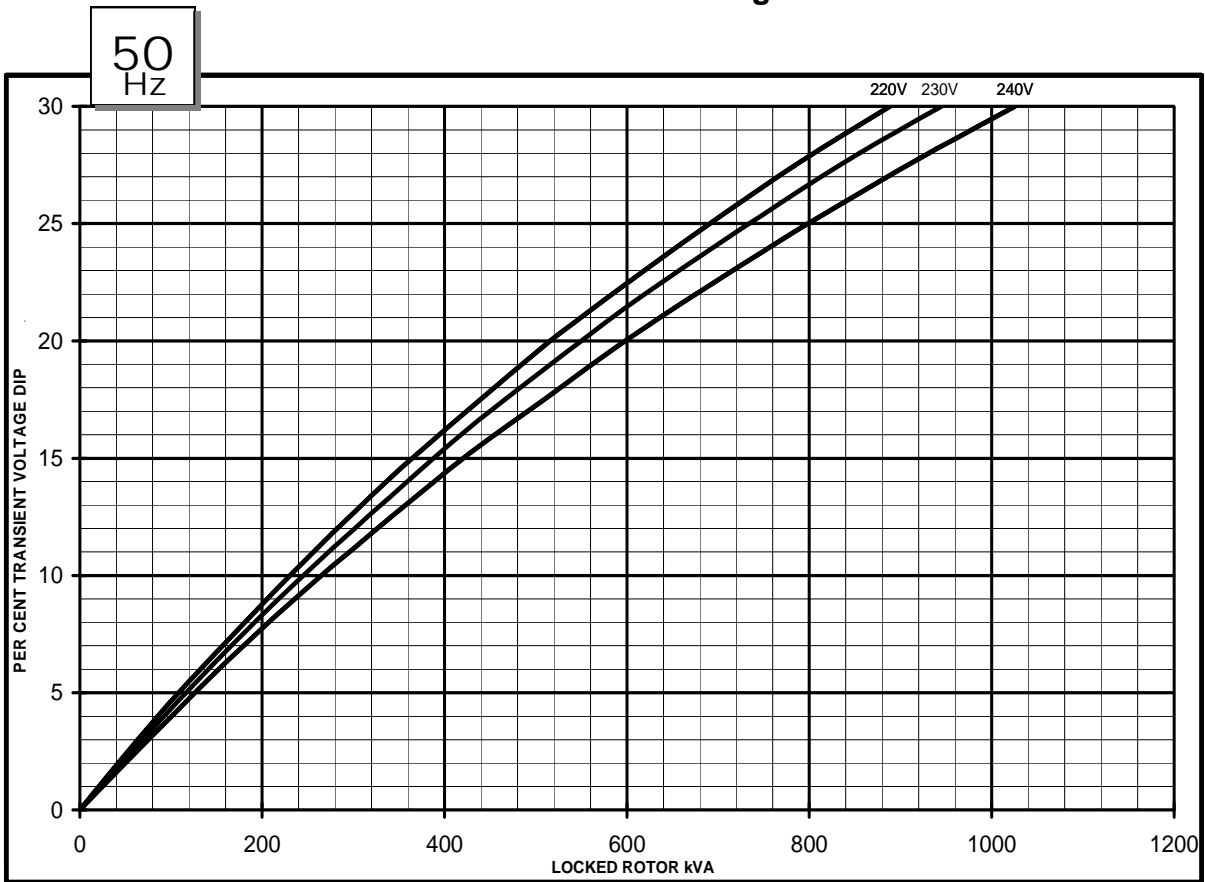

# HCM534D



## Winding 311 Single Phase

### Single Phase Short Circuit Decrement Curve. No-load Excitation at Rated Speed Based on Double Delta connection.

50  
Hz

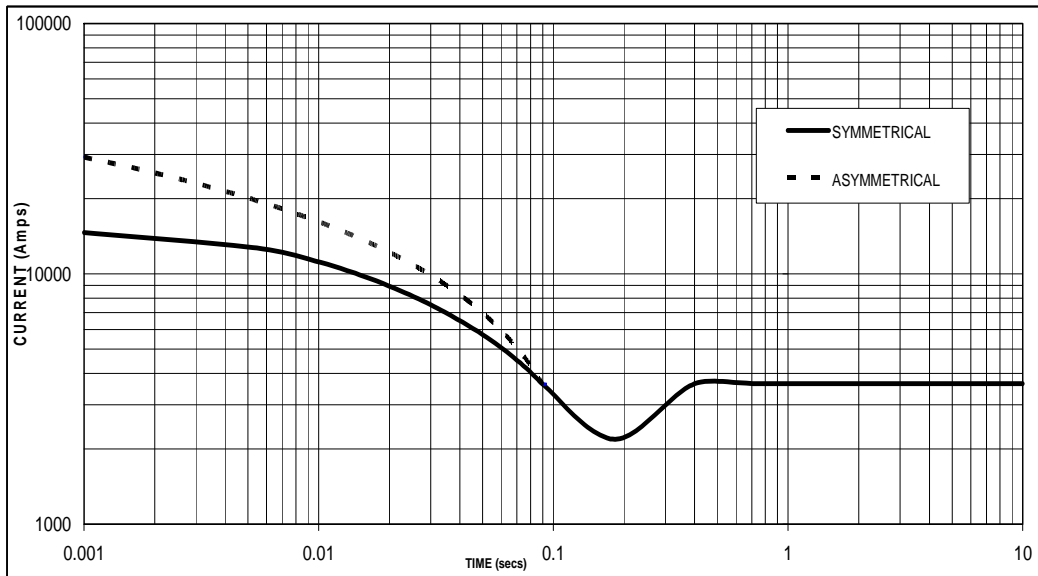

Sustained Short Circuit = 3636 Amps

OVER

60  
Hz

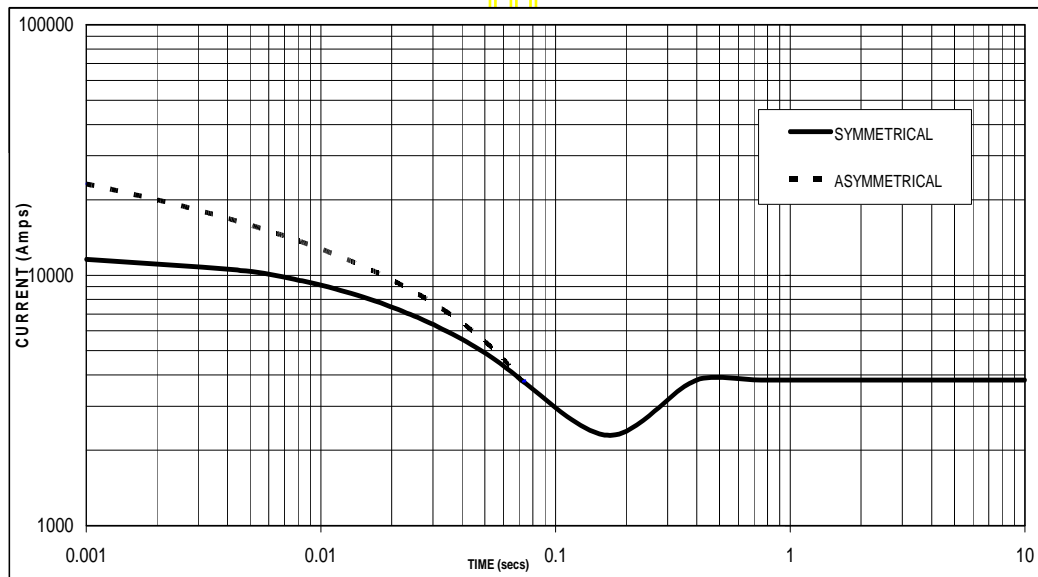

Sustained Short Circuit = 3818 Amps

**Note**

The following multiplication factors should be used to adjust the values from curve between time 0.001 seconds and the minimum current point in respect of nominal operating voltage :

Voltage	Factor
220V	X 1.00
230V	X 1.05
240V	X 1.09

The sustained current value is constant irrespective of voltage level

**Winding 311 Single Phase**

**RATINGS**

**50Hz**

Class - Temp Rise	Cont. E - 65/50°C <b>0.8pf</b>			Cont. B - 70/50°C <b>0.8pf</b>			Cont. F - 90/50°C <b>0.8pf</b>			Cont. H - 110/50°C <b>0.8pf</b>		
Double Delta (V)	220	230	240	220	230	240	220	230	240	220	230	240
Parallel Delta (V)	110	115	120	110	115	120	110	115	120	110	115	120
kVA	130	130	130	135	135	135	157	157	157	174	174	174
kW	104	104	104	108	108	108	126	126	126	139	139	139
Efficiency (%)	91.3	91.1	90.9	91.4	91.2	91.1	91.8	91.7	91.6	91.9	91.9	91.8
kW Input	114	114	114	118	118	119	137	137	138	151	151	151

Class - Temp Rise	Cont. E - 65/50°C <b>1.0pf</b>			Cont. B - 70/50°C <b>1.0pf</b>			Cont. F - 90/50°C <b>1.0pf</b>			Cont. H - 110/50°C <b>1.0pf</b>		
Double Delta (V)	220	230	240	220	230	240	220	230	240	220	230	240
Parallel Delta (V)	110	115	120	110	115	120	110	115	120	110	115	120
kVA	130	130	130	135	135	135	157	157	157	174	174	174
kW	130	130	130	135	135	135	157	157	157	174	174	174
Efficiency (%)	93.1	93.0	92.9	93.2	93.1	93.0	93.6	93.5	93.4	93.7	93.7	93.6
kW Input	140	140	140	145	145	145	168	168	168	186	186	186

**60Hz**

Class - Temp Rise	Cont. E - 65/50°C <b>0.8pf</b>			Cont. B - 70/50°C <b>0.8pf</b>			Cont. F - 90/50°C <b>0.8pf</b>			Cont. H - 110/50°C <b>0.8pf</b>		
Double Delta (V)	220	230	240	220	230	240	220	230	240	220	230	240
Parallel Delta (V)	110	115	120	110	115	120	110	115	120	110	115	120
kVA	138	147	155	147	155	162	169	178	186	183	192	200
kW	110	118	124	118	124	130	135	142	149	146	154	160
Efficiency (%)	90.7	90.9	91.0	91.0	91.1	91.2	91.3	91.5	91.5	91.5	91.6	91.7
kW Input	121	130	136	130	136	143	148	155	163	160	168	174

Class - Temp Rise	Cont. E - 65/50°C <b>1.0pf</b>			Cont. B - 70/50°C <b>1.0pf</b>			Cont. F - 90/50°C <b>1.0pf</b>			Cont. H - 110/50°C <b>1.0pf</b>		
Double Delta (V)	220	230	240	220	230	240	220	230	240	220	230	240
Parallel Delta (V)	110	115	120	110	115	120	110	115	120	110	115	120
kVA	138	147	155	147	155	162	169	178	186	183	192	200
kW	138	147	155	147	155	162	169	178	186	183	192	200
Efficiency (%)	92.6	92.8	92.9	92.8	92.9	93.0	93.1	93.2	93.3	93.3	93.4	93.4
kW Input	149	158	167	158	167	174	182	191	199	196	206	214



**DIMENSIONS**

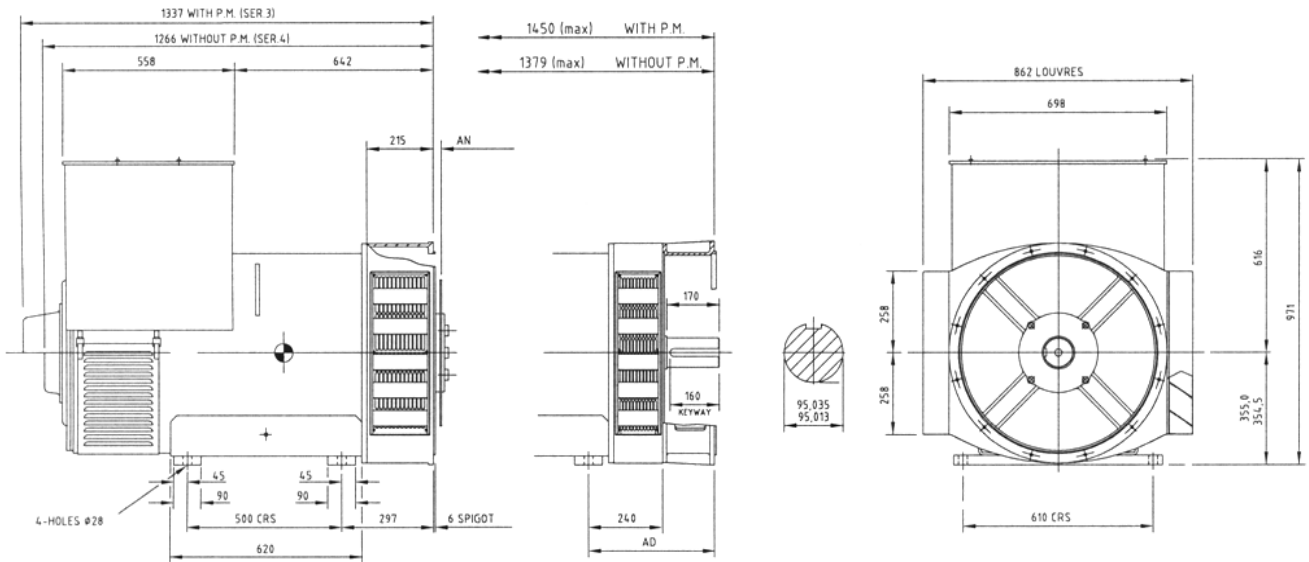

COUPLING DISC	AN
SAE 14	25,4
SAE 18	15,87
SAE 21	0

ADAPTOR	AD
SAE 00	410
SAE 0	410
SAE 1/2	390
SAE 1	390

DOCUMENT

APPROVED DOCUMENT

## **STAMFORD**

Head Office Address:  
Barnack Road, Stamford  
Lincolnshire, PE9 2NB  
United Kingdom  
Tel: +44 (0) 1780 484000  
Fax: +44 (0) 1780 484100

[www.cumminsgeneratortechnologies.com](http://www.cumminsgeneratortechnologies.com)

Copyright 2010, Cummins Generator Technologies Ltd, All Rights Reserved  
Stamford and AvK are registered trade marks of Cummins Generator Technologies Ltd  
Cummins and the Cummins logo are registered trade marks of Cummins Inc.