

STAMFORD®

HCM634G - Winding 311 and 312

Technical  Data Sheet

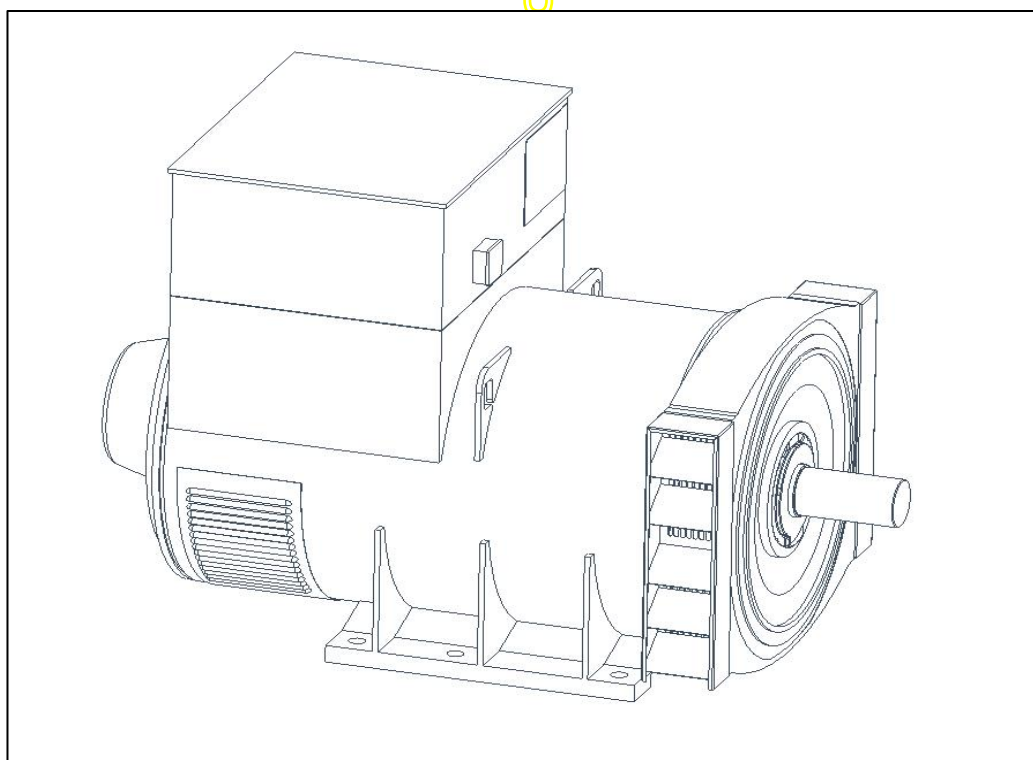

HCM634G

SPECIFICATIONS & OPTIONS

WINDING 311 and 312

STAMFORD

STANDARDS

Stamford industrial generators meet the requirements of BS EN 60034 and the relevant section of other international standards such as BS5000, VDE 0530, NEMA MG1-32, IEC34, CSA C22.2-100, AS1359. Other standards and certifications can be considered on request.

VOLTAGE REGULATORS

MX321 AVR - STANDARD

This sophisticated Automatic Voltage Regulator (AVR) is incorporated into the Stamford Permanent Magnet Generator (PMG) system and is fitted as standard to generators of this type.

The PMG provides power via the AVR to the main exciter, giving a source of constant excitation power independent of generator output. The main exciter output is then fed to the main rotor, through a full wave bridge, protected by a surge suppressor. The AVR has in-built protection against sustained over-excitation, caused by internal or external faults. This de-excites the machine after a minimum of 5 seconds.

Over voltage protection is built-in and short circuit current level adjustments is an optional facility.

WINDINGS & ELECTRICAL PERFORMANCE

All generator stators are wound to 2/3 pitch. This eliminates triplen (3rd, 9th, 15th ...) harmonics on the voltage waveform and is found to be the optimum design for trouble-free supply of non-linear loads. The 2/3 pitch design avoids excessive neutral currents sometimes seen with higher winding pitches, when in parallel with the mains. A fully connected damper winding reduces oscillations during paralleling. This winding, with the 2/3 pitch and carefully selected pole and tooth designs, ensures very low waveform distortion.

TERMINALS & TERMINAL BOX

Standard generators feature a main stator with either 6 ends (Winding 312) or 12 ends (Winding 311) brought out to the terminals, which are mounted on the frame at the non-drive end of the generator. A sheet steel terminal box contains the AVR and provides ample space for the customers' wiring and gland arrangements. It has removable panels for easy access.

SHAFT & KEYS

All generator rotors are dynamically balanced to better than BS6861:Part 1 Grade 2.5 for minimum vibration in operation. Two bearing generators are balanced with a half key.

INSULATION/IMPREGNATION

The insulation system is class 'H'.

All wound components are impregnated with materials and processes designed specifically to provide the high build required for static windings and the high mechanical strength required for rotating components.

QUALITY ASSURANCE

Generators are manufactured using production procedures having a quality assurance level to BS EN ISO 9001.

The stated voltage regulation may not be maintained in the presence of certain radio transmitted signals. Any change in performance will fall within the limits of Criteria 'B' of EN 61000-6-2:2001. At no time will the steady-state voltage regulation exceed 2%.

DE RATES

All values tabulated on page 8 are subject to the following reductions

5% when air inlet filters are fitted.

10% when IP44 Filters are fitted.

3% for every 500 metres by which the operating altitude exceeds 1000 metres above mean sea level.

3% for every 5°C by which the operational ambient temperature exceeds 40°C.

Note: Requirement for operating in an ambient exceeding 60°C must be referred to the factory.

NB Continuous development of our products entitles us to change specification details without notice, therefore they must not be regarded as binding.

Front cover drawing typical of product range.

APPROVED DOCUMENT

HCM634G



WINDING 311 and 312

| | | | | | | | | |
|--|--|--------------------------|---------|---|------------------------------------|---------|---------|---------|
| CONTROL SYSTEM | SEPARATELY EXCITED BY P.M.G. | | | | | | | |
| A.V.R. | MX321 | | | | | | | |
| VOLTAGE REGULATION | ± 0.5 % | With 4% ENGINE GOVERNING | | | | | | |
| SUSTAINED SHORT CIRCUIT | REFER TO SHORT CIRCUIT DECREMENT CURVES (page 7) | | | | | | | |
| INSULATION SYSTEM | CLASS H | | | | | | | |
| PROTECTION | IP23 | | | | | | | |
| RATED POWER FACTOR | 0.8 | | | | | | | |
| STATOR WINDING | DOUBLE LAYER LAP | | | | | | | |
| WINDING PITCH | TWO THIRDS | | | | | | | |
| WINDING LEADS | 6 (Wdg 312) or 12 (Wdg 311) | | | | | | | |
| STATOR WDG. RESISTANCE | 0.0034 Ohms PER PHASE AT 22°C STAR CONNECTED | | | | | | | |
| ROTOR WDG. RESISTANCE | 1.75 Ohms at 22°C | | | | | | | |
| EXCITER STATOR RESISTANCE | 17 Ohms at 22°C | | | | | | | |
| EXCITER ROTOR RESISTANCE | 0.079 Ohms PER PHASE AT 22°C | | | | | | | |
| R.F.I. SUPPRESSION | BS EN 61000-6-2 & BS EN 61000-6-4, VDE 0875G, VDE 0875N. refer to factory for others | | | | | | | |
| WAVEFORM DISTORTION | NO LOAD < 1.5% NON-DISTORTING BALANCED LINEAR LOAD < 5.0% | | | | | | | |
| MAXIMUM OVERSPEED | 2250 Rev/Min | | | | | | | |
| BEARING DRIVE END | BALL. 6224 (ISO) | | | | | | | |
| BEARING NON-DRIVE END | BALL. 6317 (ISO) | | | | | | | |
| | 1 BEARING | | | | 2 BEARING | | | |
| WEIGHT COMP. GENERATOR | 1965 kg | | | | 1989 kg | | | |
| WEIGHT WOUND STATOR | 934 kg | | | | 934 kg | | | |
| WEIGHT WOUND ROTOR | 814 kg | | | | 766 kg | | | |
| WR ² INERTIA | 18.3482 kgm ² | | | | 17.8009 kgm ² | | | |
| SHIPPING WEIGHTS in a crate | 2023 kg | | | | 2029kg | | | |
| PACKING CRATE SIZE | 183 x 92 x 140(cm) | | | | 183 x 92 x 140(cm) | | | |
| | 50 Hz | | | | 60 Hz | | | |
| TELEPHONE INTERFERENCE | THF<2% | | | | TIF<50 | | | |
| COOLING AIR | 1.614 m ³ /sec 3420 cfm | | | | 1.961 m ³ /sec 4156 cfm | | | |
| VOLTAGE STAR | 380/220 | 400/231 | 415/240 | 440/254 | 416/240 | 440/254 | 460/266 | 480/277 |
| VOLTAGE DELTA | 220 | 230 | 240 | 254 | 240 | 254 | 266 | 277 |
| kVA BASE RATING FOR REACTANCE VALUES | 630 | 650 | 675 | 675 | 788 | 813 | 856 | 875 |
| X _d DIR. AXIS SYNCHRONOUS | 2.47 | 2.30 | 2.22 | 1.97 | 3.18 | 2.94 | 2.83 | 2.65 |
| X' _d DIR. AXIS TRANSIENT | 0.20 | 0.19 | 0.18 | 0.16 | 0.25 | 0.23 | 0.22 | 0.21 |
| X'' _d DIR. AXIS SUBTRANSIENT | 0.14 | 0.13 | 0.13 | 0.11 | 0.19 | 0.18 | 0.17 | 0.16 |
| X _q QUAD. AXIS REACTANCE | 1.48 | 1.38 | 1.33 | 1.18 | 1.89 | 1.74 | 1.68 | 1.58 |
| X'' _q QUAD. AXIS SUBTRANSIENT | 0.17 | 0.15 | 0.15 | 0.14 | 0.22 | 0.20 | 0.20 | 0.18 |
| X _L LEAKAGE REACTANCE | 0.08 | 0.07 | 0.07 | 0.06 | 0.11 | 0.10 | 0.09 | 0.09 |
| X ₂ NEGATIVE SEQUENCE | 0.17 | 0.16 | 0.16 | 0.14 | 0.22 | 0.20 | 0.20 | 0.18 |
| X ₀ ZERO SEQUENCE | 0.02 | 0.02 | 0.03 | 0.02 | 0.03 | 0.03 | 0.03 | 0.03 |
| REACTANCES ARE SATURATED | | | | VALUES ARE PER UNIT AT RATING AND VOLTAGE INDICATED | | | | |
| T' _d TRANSIENT TIME CONST. | 0.185 s | | | | | | | |
| T'' _d SUB-TRANSTIME CONST. | 0.025 s | | | | | | | |
| T' _{do} O.C. FIELD TIME CONST. | 2.35 s | | | | | | | |
| T _a ARMATURE TIME CONST. | 0.04 s | | | | | | | |
| SHORT CIRCUIT RATIO | 1/X _d | | | | | | | |

50
Hz

HCM634G
Winding 311 and 312

STAMFORD

THREE PHASE EFFICIENCY CURVES

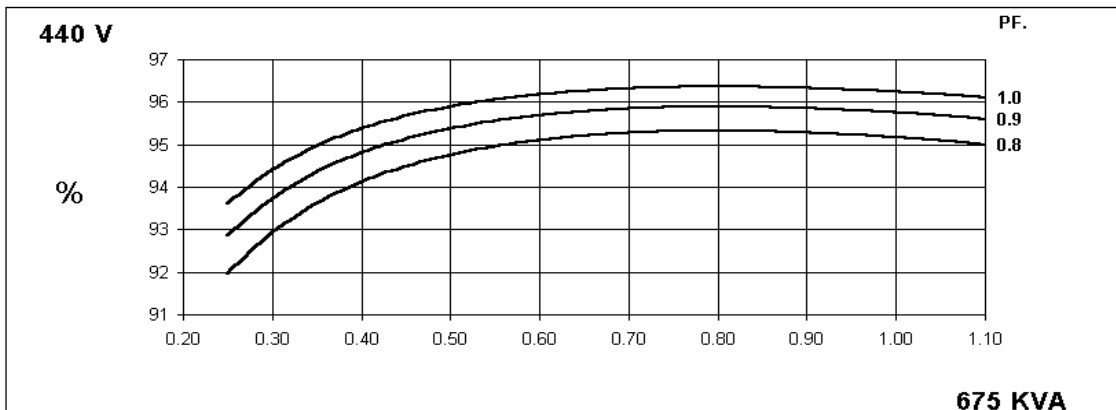
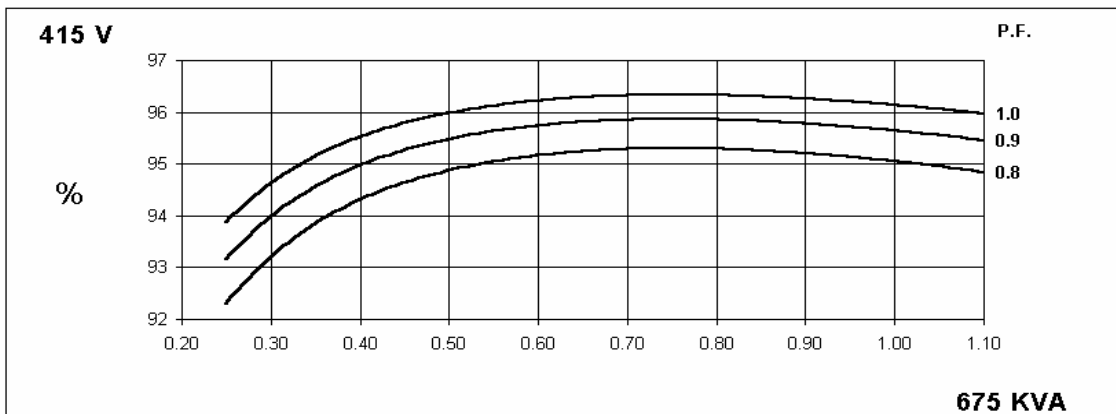
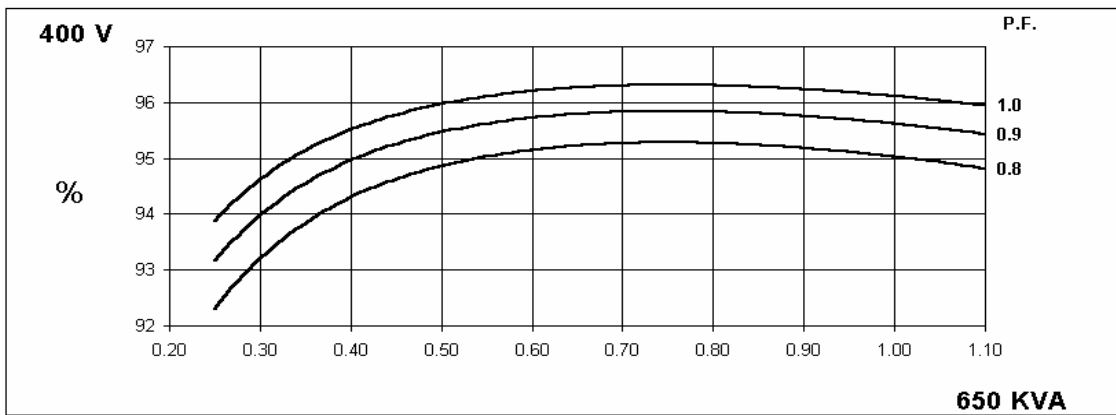
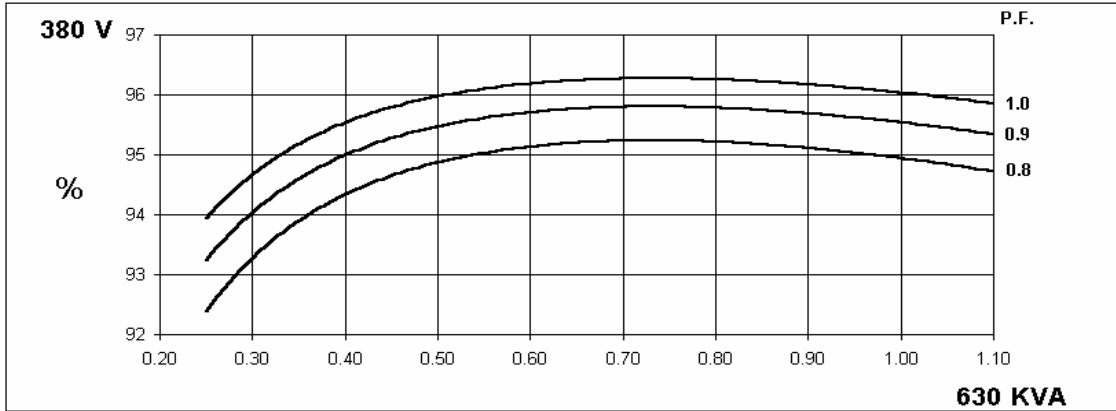

60
Hz

HCM634G
Winding 311 and 312

STAMFORD

THREE PHASE EFFICIENCY CURVES

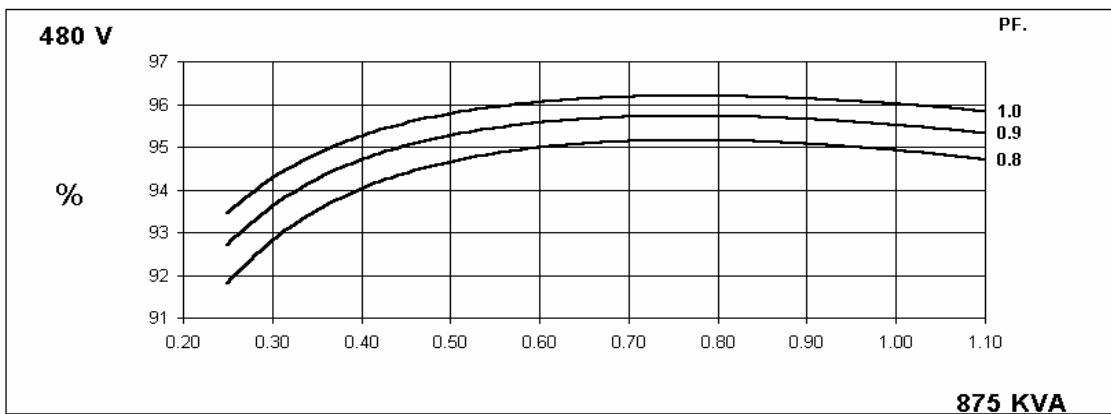
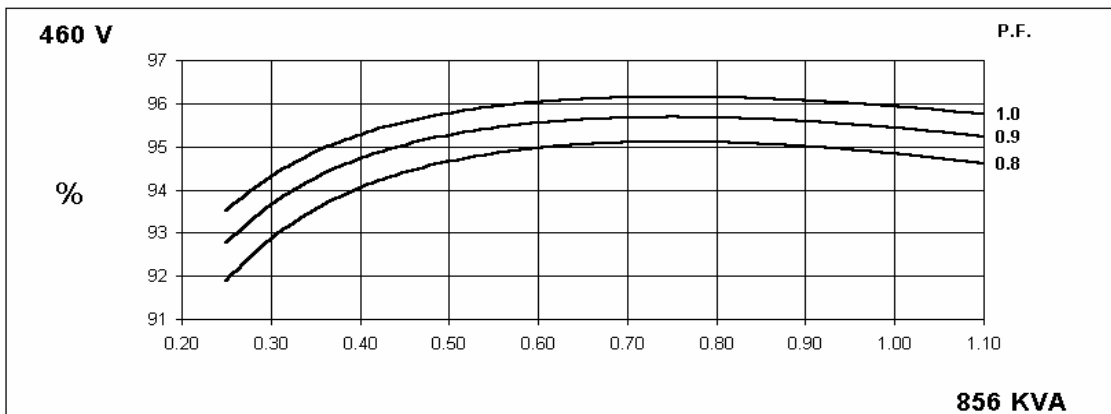
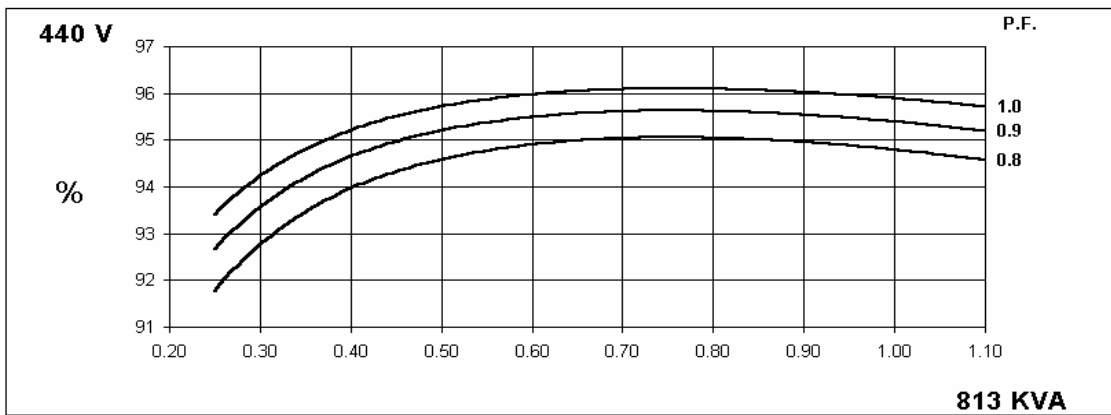
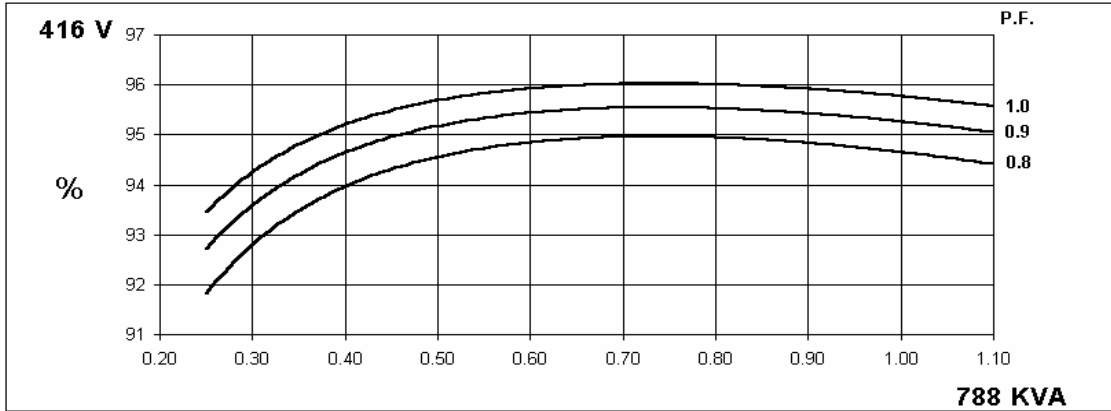

Locked Rotor Motor Starting Curve

50
Hz

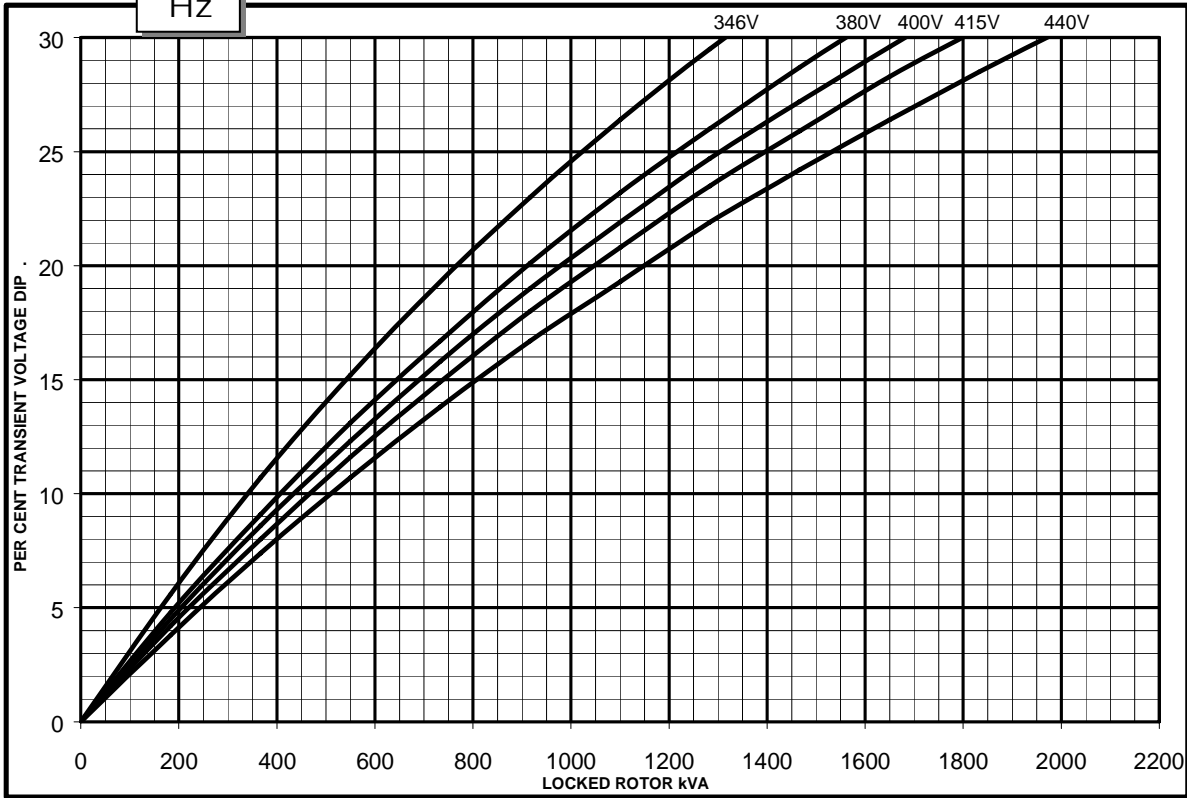

60
Hz

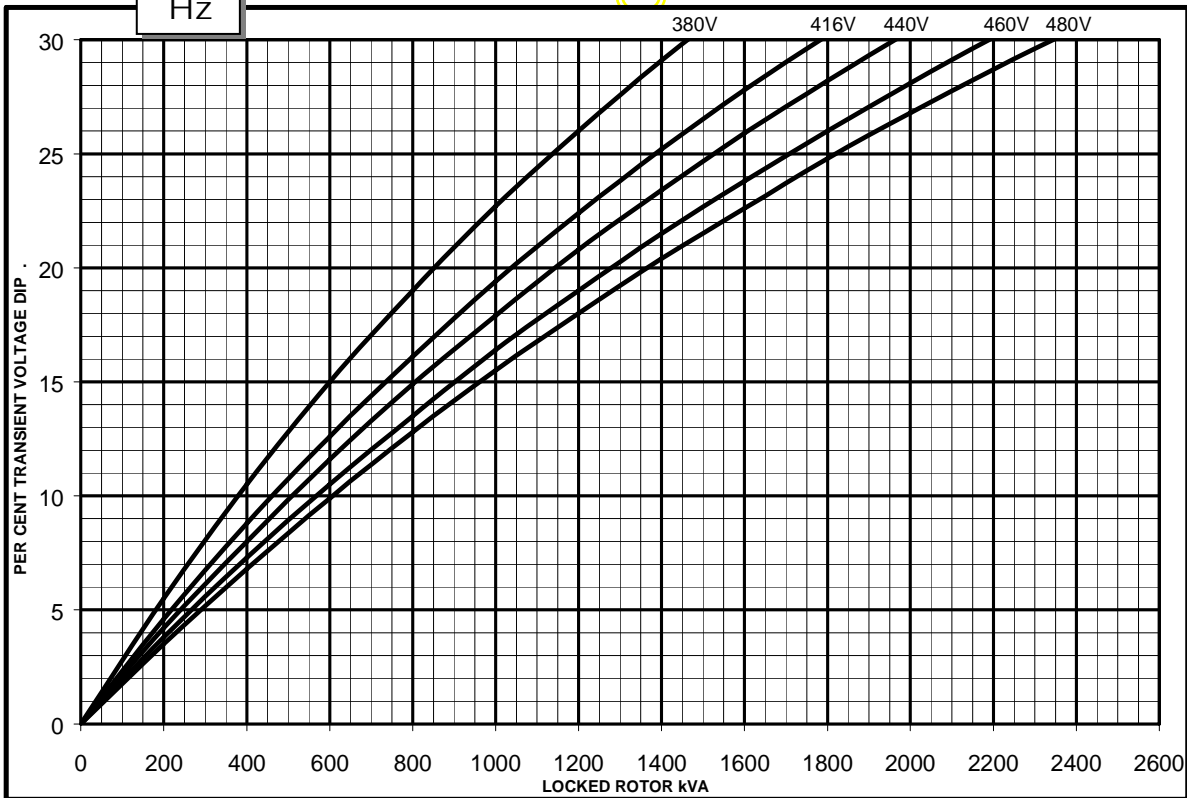

WINDING 311 and 312

Three-phase Short Circuit Decrement Curve. No-load Excitation at Rated Speed
Based on star (wye) connection.

50
Hz

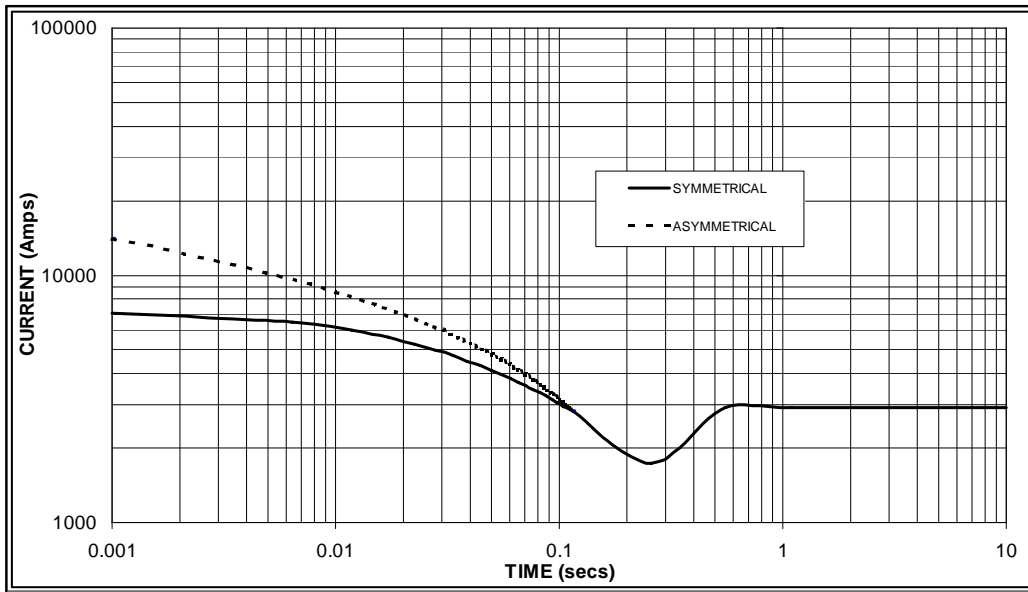

Sustained Short Circuit = 2,900 Amps



60
Hz

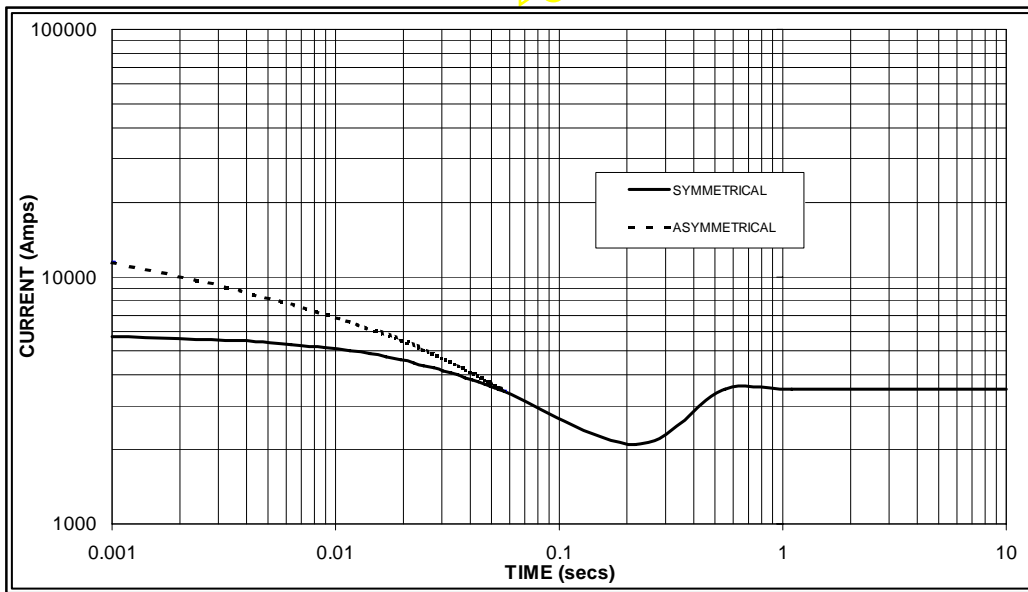

Sustained Short Circuit = 3,500 Amps

Note 1

The following multiplication factors should be used to adjust the values from curve between time 0.001 seconds and the minimum current point in respect of nominal operating voltage :

| 50Hz | | 60Hz | |
|---------|--------|---------|--------|
| Voltage | Factor | Voltage | Factor |
| 380v | X 1.00 | 416v | X 1.00 |
| 400v | X 1.07 | 440v | X 1.06 |
| 415v | X 1.12 | 460v | X 1.12 |
| 440v | X 1.18 | 480v | X 1.17 |

The sustained current value is constant irrespective of voltage level

Note 2

The following multiplication factor should be used to convert the values calculated in accordance with NOTE 1 to those applicable to the various types of short circuit :

| | 3-phase | 2-phase L-L | 1-phase L-N |
|-------------------------|---------|-------------|-------------|
| Instantaneous | x 1.00 | x 0.87 | x 1.30 |
| Minimum | x 1.00 | x 1.80 | x 3.20 |
| Sustained | x 1.00 | x 1.50 | x 2.50 |
| Max. sustained duration | 10 sec. | 5 sec. | 2 sec. |

All other times are unchanged

Note 3

Curves are drawn for Star (Wye) connected machines. For Delta connection multiply the Curve current value by 1.732

HCM634G

STAMFORD

Winding 311 and 312 0.8 Power Factor

RATINGS

| Class - Temp Rise | Cont. E - 65/50°C | | | | Cont. B - 70/50°C | | | | Cont. F - 90/50°C | | | | Cont. H - 110/50°C | | | | |
|-------------------|---------------------|------|------|------|-------------------|------|------|------|-------------------|------|------|------|--------------------|------|------|------|------|
| 50Hz | Star (V) | 380 | 400 | 415 | 440 | 380 | 400 | 415 | 440 | 380 | 400 | 415 | 440 | 380 | 400 | 415 | 440 |
| | Parallel Star (V) * | 180 | 200 | 208 | 220 | 180 | 200 | 208 | 220 | 180 | 200 | 208 | 220 | 180 | 200 | 208 | 220 |
| | Delta (V) | 220 | 230 | 240 | 254 | 220 | 230 | 240 | 254 | 220 | 230 | 240 | 254 | 220 | 230 | 240 | 254 |
| | kVA | 500 | 520 | 540 | 540 | 530 | 550 | 570 | 570 | 630 | 650 | 675 | 675 | 630 | 650 | 675 | 675 |
| | kW | 400 | 416 | 432 | 432 | 424 | 440 | 456 | 456 | 504 | 520 | 540 | 540 | 504 | 520 | 540 | 540 |
| | Efficiency (%) | 95.2 | 95.3 | 95.3 | 95.3 | 95.2 | 95.2 | 95.3 | 95.3 | 94.9 | 95.0 | 95.1 | 95.2 | 94.9 | 95.0 | 95.1 | 95.2 |
| | kW Input | 420 | 437 | 453 | 453 | 445 | 462 | 478 | 478 | 531 | 547 | 568 | 567 | 531 | 547 | 568 | 567 |
| 60Hz | Star (V) | 416 | 440 | 460 | 480 | 416 | 440 | 460 | 480 | 416 | 440 | 460 | 480 | 416 | 440 | 460 | 480 |
| | Parallel Star (V) * | 208 | 220 | 230 | 240 | 208 | 220 | 230 | 240 | 208 | 220 | 230 | 240 | 208 | 220 | 230 | 240 |
| | Delta (V) | 240 | 254 | 266 | 277 | 240 | 254 | 266 | 277 | 240 | 254 | 266 | 277 | 240 | 254 | 266 | 277 |
| | kVA | 613 | 640 | 665 | 688 | 638 | 662 | 688 | 712 | 731 | 763 | 800 | 819 | 788 | 813 | 856 | 875 |
| | kW | 490 | 512 | 532 | 550 | 510 | 530 | 550 | 570 | 585 | 610 | 640 | 655 | 630 | 650 | 685 | 700 |
| | Efficiency (%) | 95.0 | 95.0 | 95.1 | 95.2 | 94.9 | 95.0 | 95.1 | 95.2 | 94.8 | 94.9 | 95.0 | 95.0 | 94.7 | 94.8 | 94.8 | 94.9 |
| | kW Input | 516 | 539 | 559 | 578 | 538 | 557 | 579 | 598 | 617 | 643 | 674 | 690 | 666 | 686 | 722 | 738 |

* Parallel Star only available with Wdg 311

DIMENSIONS

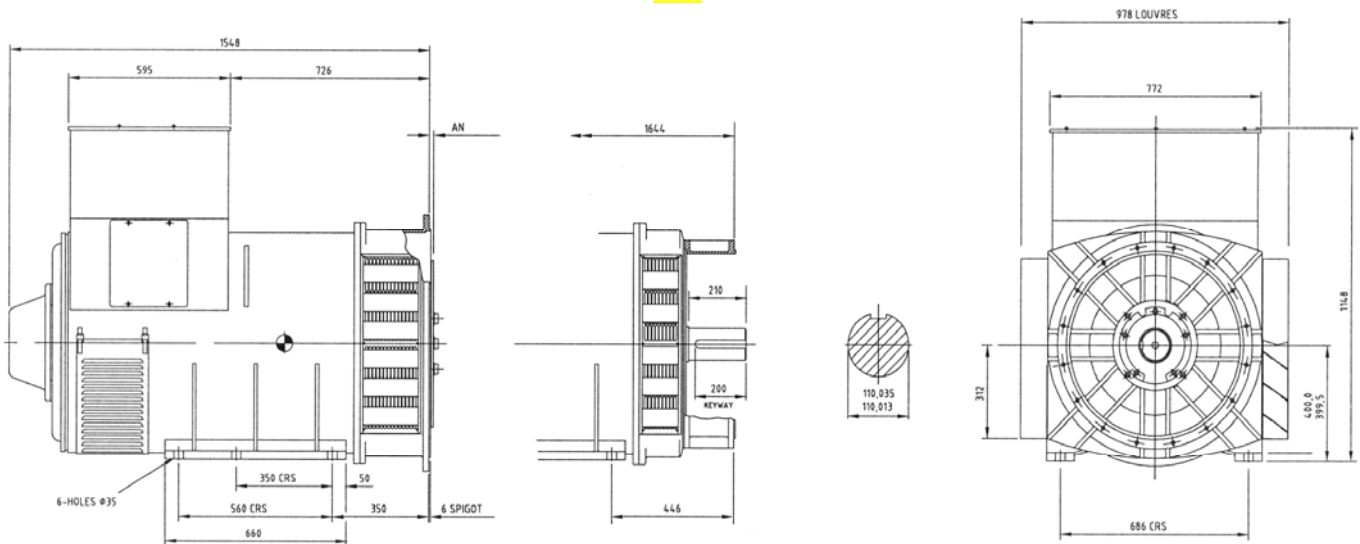

| COUPLING DISC | AN |
|---------------|-------|
| SAE 14 | 25.4 |
| SAE 18 | 19.87 |
| SAE 21 | 0 |
| SAE 24 | 0 |

APPROVED DOCUMENT

STAMFORD

Head Office Address:
Barnack Road, Stamford
Lincolnshire, PE9 2NB
United Kingdom
Tel: +44 (0) 1780 484000
Fax: +44 (0) 1780 484100

www.cumminsgeneratortechnologies.com

Copyright 2010, Cummins Generator Technologies Ltd, All Rights Reserved
Stamford and AvK are registered trade marks of Cummins Generator Technologies Ltd
Cummins and the Cummins logo are registered trade marks of Cummins Inc.