

STAMFORD® | AvK®

LV 804 R WDG 12 - Technical Data Sheet

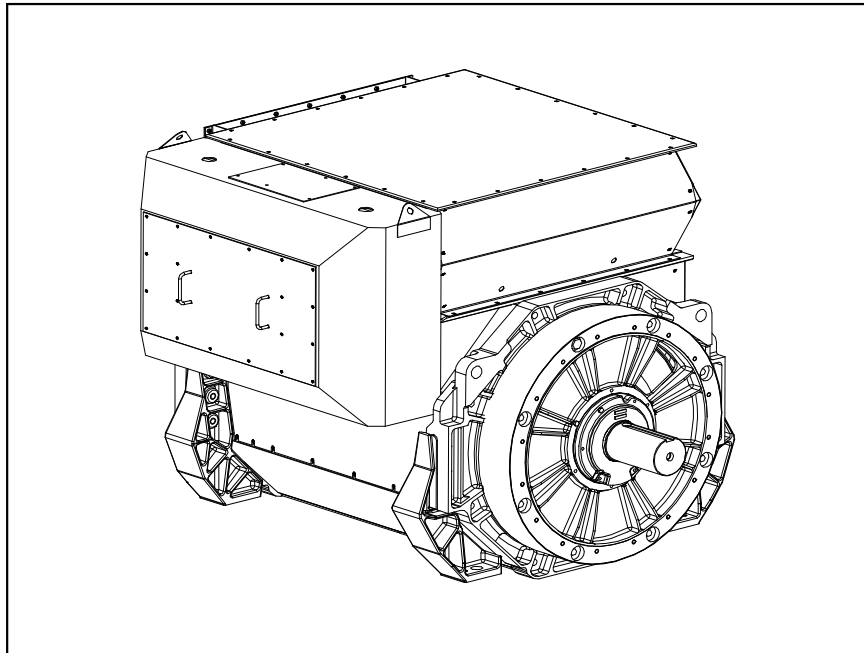

FRAME LV 804 R

SPECIFICATIONS & OPTIONS

STAMFORD | AvK

STANDARDS

Cummins Generator Technologies industrial generators meet the requirements of BS EN 60034 and the relevant sections of other national and international standards such as BS5000, VDE 0530, NEMA MG1-32, IEC60034, CSA C22.2-100, AS1359. Other standards and certifications can be considered on request.

DESCRIPTION

The STAMFORD PI range of synchronous ac generators are brushless with a rotating field. They are separately excited by the STAMFORD Permanent Magnet Generator (PMG). This is a shaft mounted, high frequency, pilot exciter which provides a constant supply of clean power via the Automatic Voltage Regulator (AVR) to the main exciter. The main exciter output is fed to the main rotor, through a full wave bridge rectifier, protected by surge suppression.

VOLTAGE REGULATORS

The P80 range generators complete with a PMG are available with one AVR. Underspeed protection (UFRO) is also provided by the AVR. The UFRO will reduce the generator output voltage proportional to the speed of the generator below a pre-settable level.

The STAMFORD | AvK Digital Excitation Control System (DM110) is an electronic, solid-state, microprocessor based control device. The DM110 regulates the output voltage of a the ac generator by controlling the current into the generator exciter field. Input power to the DM110 is provided by a multi-pole, high-frequency, permanent magnet generator (PMG).

The DM110 is supplied in an encapsulated package designed for behind-the-panel mounting. Front panel indicators (LEDs) annunciate DM110 status and system conditions. DM110 connections are made through quarterinch, quick-connect terminals on the rear panel. A 9-pin DB-9 type connector on the rear panel provides communication between the DM110 and an IBM compatible PC.

Technical details on the DM110 are available on the Stamford-AvK website using the following URL:
<https://www.stamford-avk.com/downloads/avr-manuals>

WINDINGS & ELECTRICAL PERFORMANCE

All generator stators are wound to 2/3 pitch. This eliminates triplen (3rd, 9th, 15th ...) harmonics on the voltage waveform and is found to be the optimum design for trouble-free supply of non-linear loads. The 2/3 pitch design avoids excessive neutral currents sometimes seen with higher winding pitches. A fully connected damper winding reduces oscillations during paralleling. This winding, with the 2/3 pitch and carefully selected pole and tooth designs, ensures very low levels of voltage waveform distortion.

TERMINALS & TERMINAL BOX

Standard generators feature a main stator with 6 ends brought out to the terminals, which are mounted on the frame at the non-drive end of the generator. A sheet steel terminal box contains the AVR and provides ample space for the customers' wiring and gland arrangements. It has removable panels for easy access.

SHAFT & KEYS

All generator rotors are dynamically balanced to better than BS6861:Part 1 Grade 2.5 for minimum vibration in operation. Two bearing generators are balanced with a half key.

INSULATION/IMPREGNATION

The insulation system is class 'H'. All wound components are impregnated with materials and processes designed specifically to provide the high build required for static windings and the high mechanical strength required for rotating components.

QUALITY ASSURANCE

Generators are manufactured using production procedures having a quality assurance level to BS EN ISO 9001.

NOTE ON REGULATION

The stated voltage regulation may not be maintained in the presence of certain radio transmitted signals. Any change in performance will fall within the limits of Criteria 'B' of EN 61000-6-2:2001. At no time will the steady-state voltage regulation exceed 2%.

NB Continuous development of our products entitles us to change specification details without notice, therefore they must not be regarded as binding.

Front cover drawing is typical of the product range.

FRAME LV 804 R WINDING 12

STAMFORD | AvK

RATINGS	REFER TO SALES AND SERVICE BRIEFING
MAXIMUM ALTITUDE	1000 METRES ABOVE SEA LEVEL
MAXIMUM AMBIENT TEMPERATURE	40° C

CONTROL SYSTEM SERIES 3	SEPARATELY EXCITED BY P.M.G.
A.V.R.	FULL WAVE RECTIFIED
VOLTAGE REGULATION	± 0.25%
SUSTAINED SHORT CIRCUIT	REFER TO SHORT CIRCUIT DECREMENT CURVES OF THIS SECTION

INSULATION SYSTEM	CLASS H
PROTECTION	IP23 STANDARD
RATED POWER FACTOR	0.8
STATOR WINDING	DOUBLE LAYER LAP
WINDING PITCH	2/3
WINDING LEADS	6
R.F.I. SUPPRESSION	BS EN 50081/2-1/2 VDE 0875G VDE 0875N For other standards apply to the factory
WAVEFORM DISTORTION	NO LOAD < 1.5% NON-DISTORTING BALANCED LINEAR LOAD < 3.0%
MAXIMUM OVERSPEED	2250 Rev/Min
BEARING DRIVE END	ISO 6232 C3
BEARING NON DRIVE END	ISO 6324 C3
EFFICIENCY	REFER TO EFFICIENCY CURVES OF THIS SECTION

FREQUENCY	50Hz				60Hz			
	THF < 2%							
TELEPHONE INTERFERENCE	3.2 m³/sec				3.7 m³/sec			
COOLING AIR	380	400	415	440	416	440	460	480
VOLTAGE STAR (Y)	380	400	415	440	416	440	460	480
KVA BASE RATING FOR REACTANCE VALUES	2290	2410	2410	2265	2600	2750	2875	3000
Xd DIRECT AXIS SYNCHRONOUS	2.95	2.80	2.60	2.17	3.35	3.16	3.03	2.90
X'd DIRECT AXIS TRANSIENT	0.232	0.221	0.205	0.171	0.264	0.249	0.239	0.229
X''d DIRECT AXIS SUB-TRANSIENT	0.172	0.164	0.152	0.127	0.196	0.186	0.177	0.170
Xq QUADRATURE AXIS REACTANCE	1.98	1.88	1.75	1.46	2.25	2.13	2.03	1.95
X''q QUAD. AXIS SUB-TRANSIENT	0.318	0.302	0.281	0.235	0.361	0.341	0.327	0.313
Xl LEAKAGE REACTANCE	0.109	0.104	0.097	0.081	0.125	0.118	0.113	0.108
X2 NEGATIVE PHASE SEQUENCE	0.246	0.234	0.217	0.182	0.280	0.265	0.254	0.243
X0 ZERO PHASE SEQUENCE	0.037	0.035	0.033	0.027	0.042	0.039	0.038	0.036

REACTANCES ARE SATURATED	VALUES ARE PER UNIT AT RATING AND VOLTAGE INDICATED TO IEC60034 TOLERANCES
T'd TRANSIENT TIME CONSTANT	0.184
T''d SUB-TRANSIENT TIME CONSTANT	0.015
T'do O.C. FIELD TIME CONSTANT	3.950
Ta ARMATURE TIME CONSTANT	0.068
SHORT CIRCUIT RATIO	1/Xd

STATOR WINDING RESISTANCE (L-N)	0.000666
ROTOR WINDING RESISTANCE	1.320
EXCITER STATOR FIELD RESISTANCE	17.50
EXCITER ROTOR RESISTANCE (L-L)	0.076
PMG STATOR RESISTANCE (L-L)	3.800

RESISTANCE VALUES ARE IN OHMS AT 20° C

NO LOAD EXCITATION VOLTAGE	15.0
FULL LOAD EXCITATION VOLTAGE	63.0

Continuous development of our products entitles us to change specification details without notice, therefore they must not be regarded as binding.

THREE PHASE EFFICIENCY CURVES

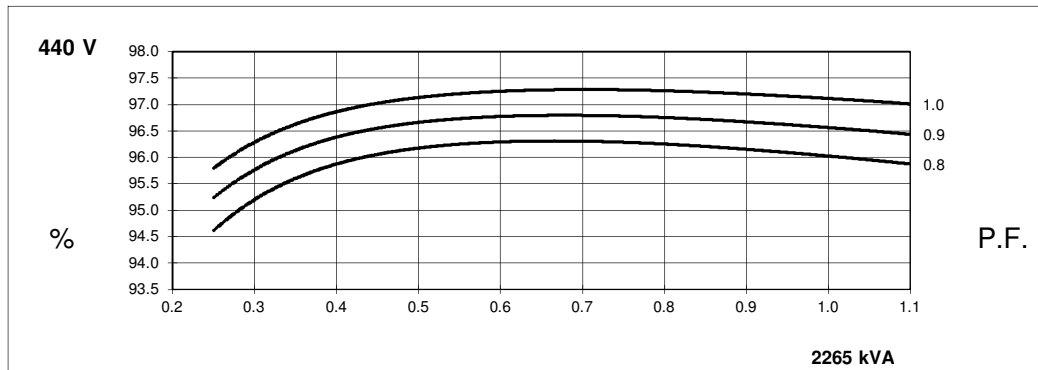
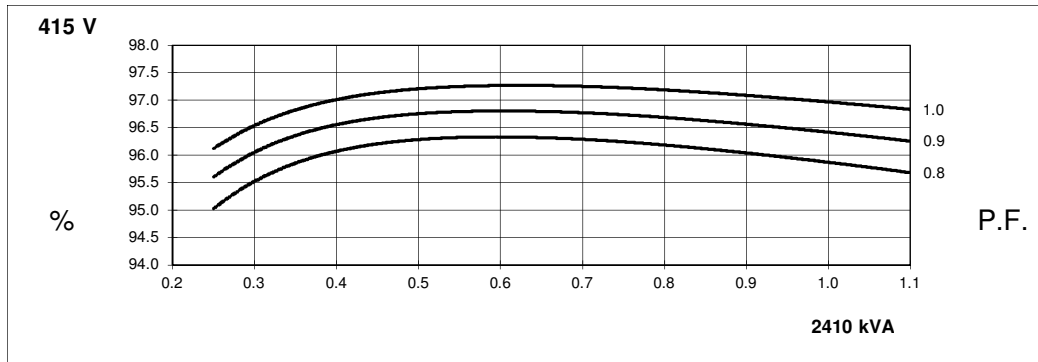
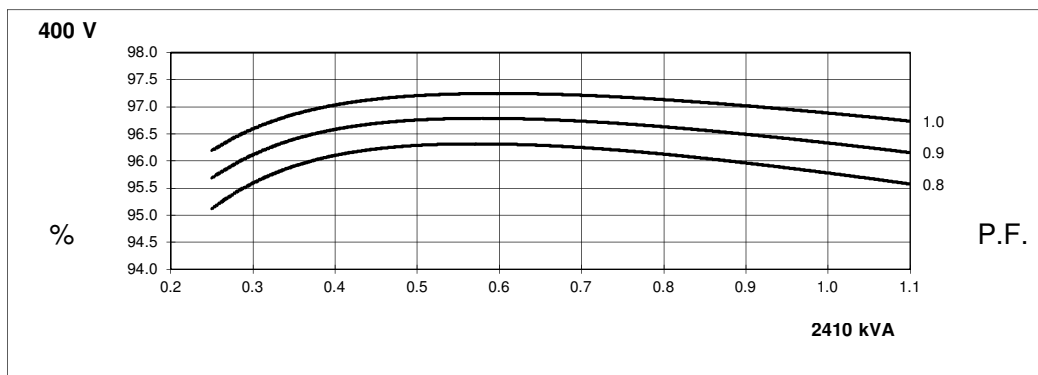
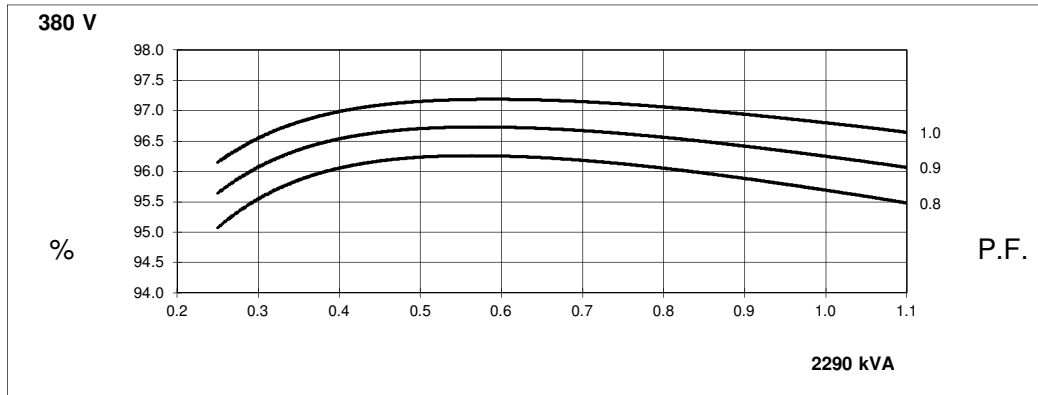

THREE PHASE EFFICIENCY CURVES

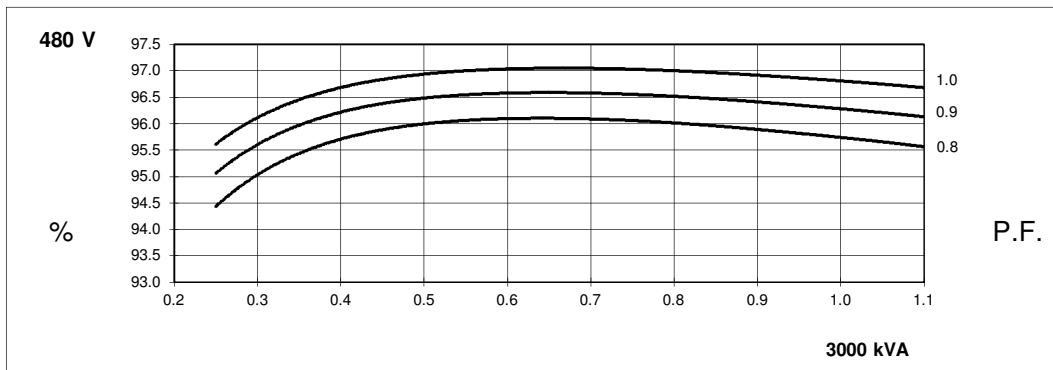
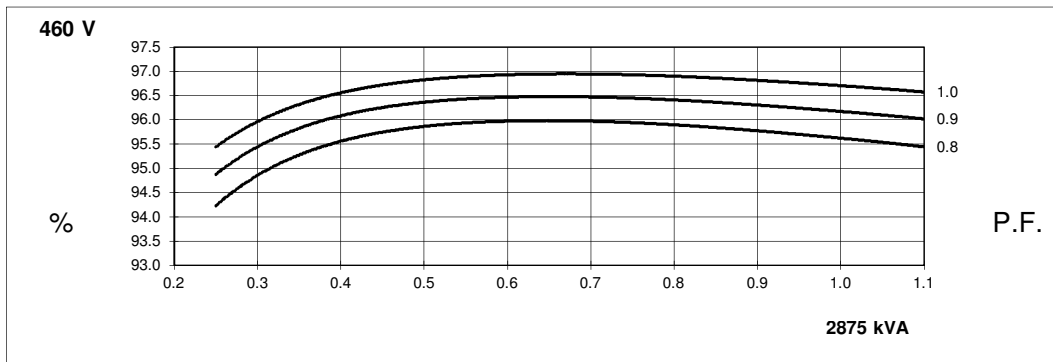
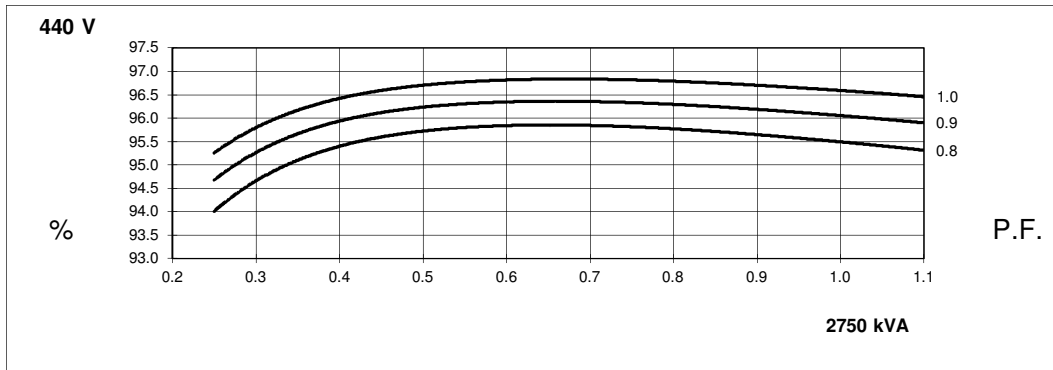
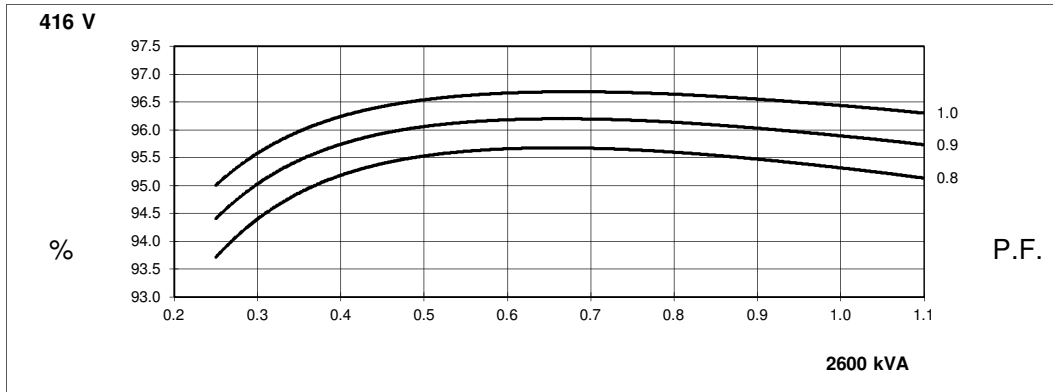

FULL WAVE RECTIFIED AVR
 LOCKED ROTOR MOTOR STARTING CURVE

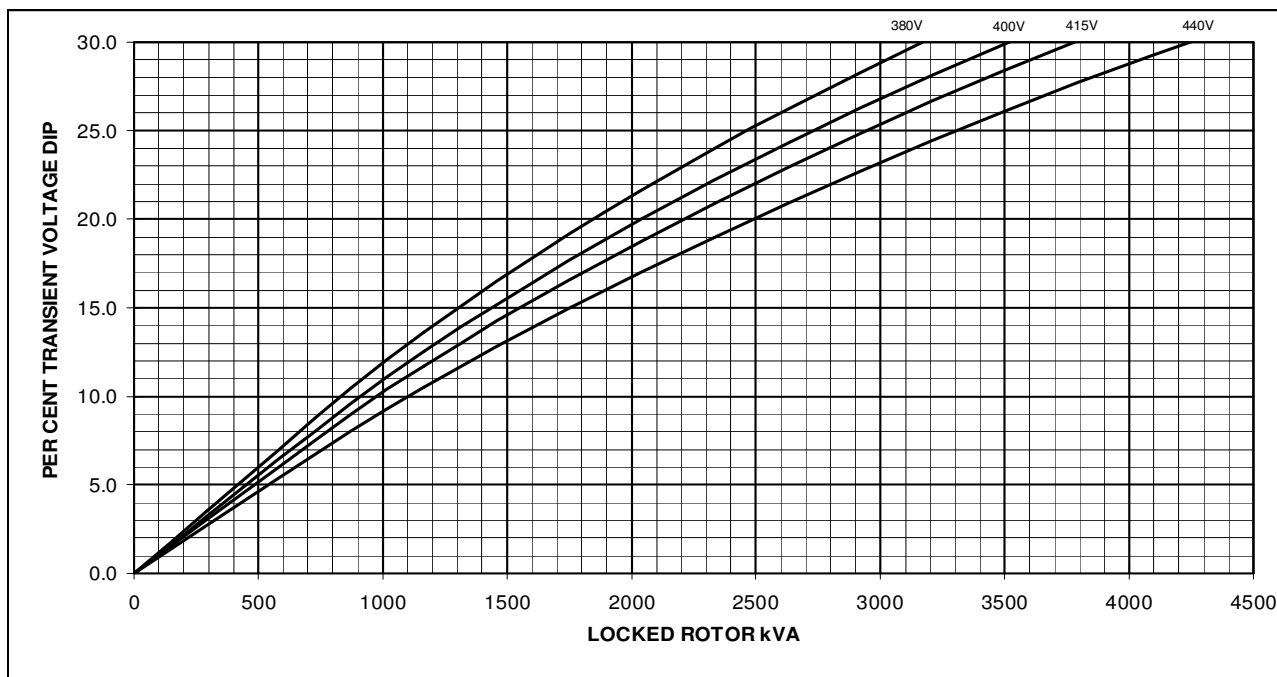

FRAME LV 804 R WDG 12 50Hz

Three Phase Short Circuit Decrement Curve
 No- Load Excitation at Rated Speed

Based on series star (wye) connection

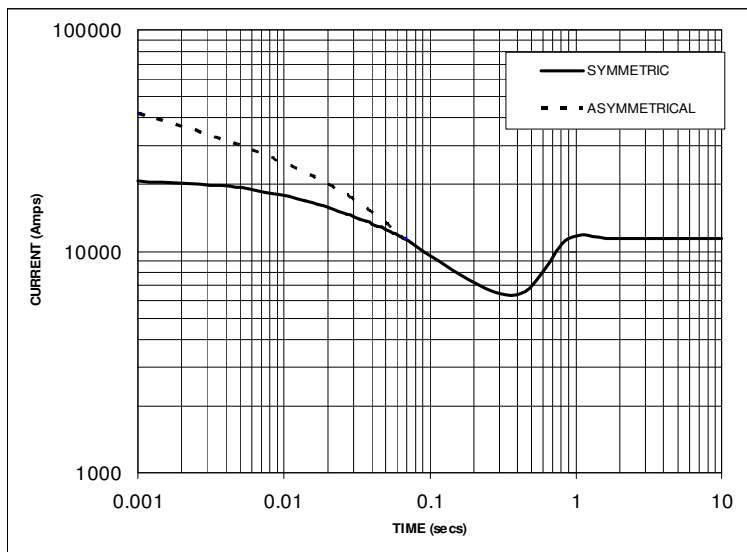

NOTE 1
 THE FOLLOWING MULTIPLICATION FACTORS SHOULD BE USED TO ADJUST THE VALUES FROM CURVES BETWEEN THE 0.001 SECONDS AND THE MINIMUM CURRENT POINT IN RESPECT OF NOMINAL OPERATING VOLTAGE

VOLTAGE	FACTOR
380V	X 0.95
400V	X 1.00
415V	X 1.04
440V	X 1.10

THE SUSTAINED CURRENT VALUE IS CONSTANT IRRESPECTIVE OF VOLTAGE LEVEL

NOTE 2
 THE FOLLOWING MULTIPLICATION FACTORS SHOULD BE USED TO CONVERT THE VALUES CALCULATED IN ACCORDANCE WITH NOTE 1 TO THOSE APPLICABLE TO THE VARIOUS TYPES OF SHORT CIRCUIT

	3 PHASE	2 PHASE L-L	1 PHASE L-N
INSTANTANEOUS	X 1.0	X 0.87	X 1.30
MINIMUM	X 1.0	X 1.80	X 3.20
SUSTAINED	X 1.0	X 1.50	X 2.50
MAX SUSTAINED DURATION	10 SEC	5 SEC	2 SEC

ALL OTHER TIMES ARE UNCHANGED

SUSTAINED SHORT CIRCUIT = 11479 Amps

FULL WAVE RECTIFIED AVR
 LOCKED ROTOR MOTOR STARTING CURVE

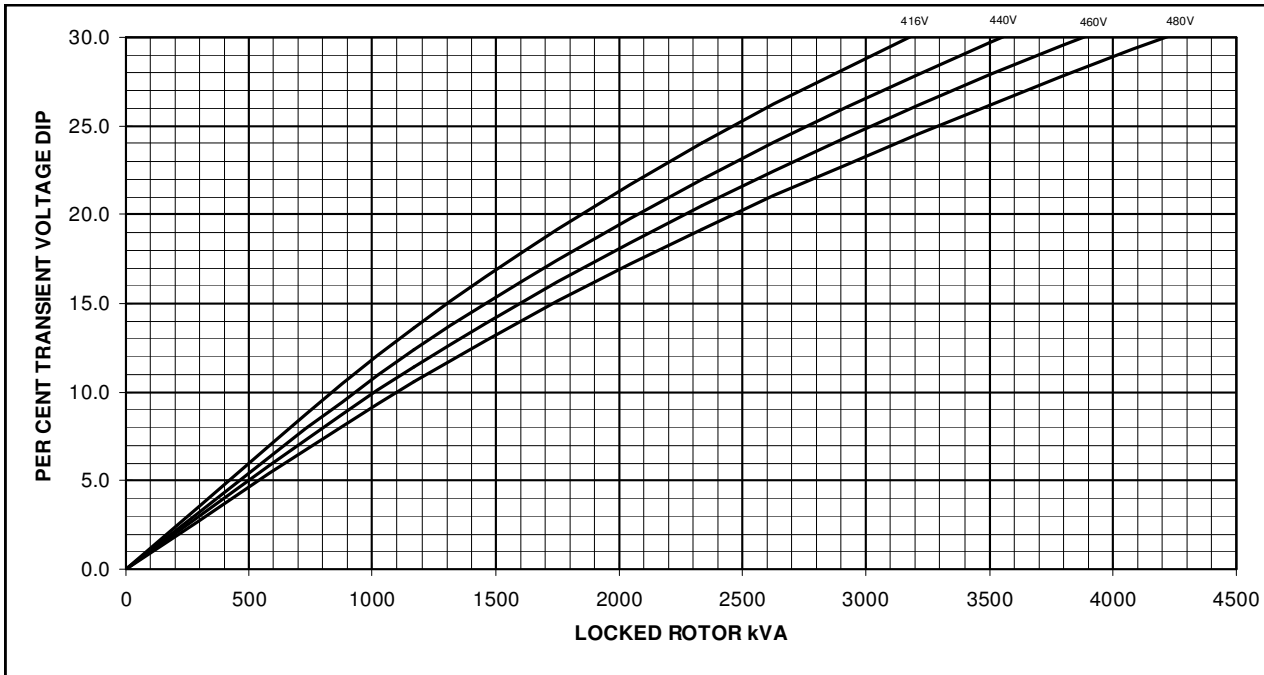

FRAME LV 804 R WDG 12 60Hz

Three Phase Short Circuit Decrement Curve
 No- Load Excitation at Rated Speed

Based on series star (wye) connection

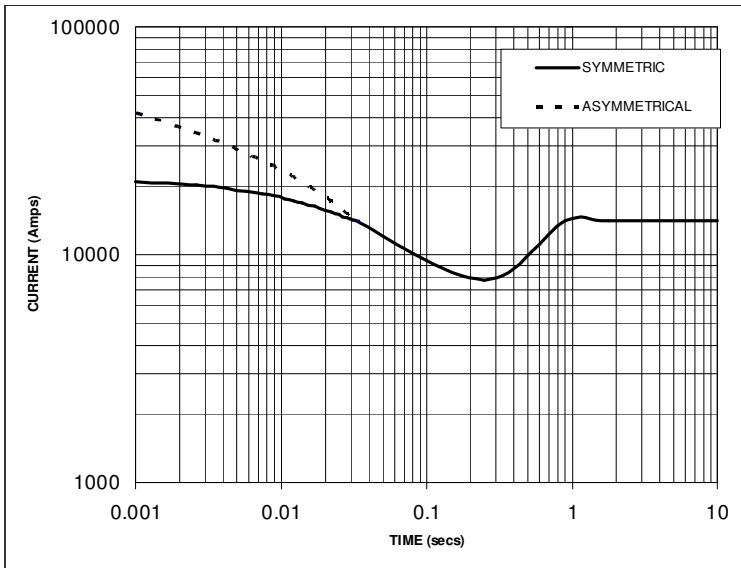

NOTE 1
 THE FOLLOWING MULTIPLICATION FACTORS SHOULD BE USED TO ADJUST THE VALUES FROM CURVES BETWEEN THE 0.001 SECONDS AND THE MINIMUM CURRENT POINT IN RESPECT OF NOMINAL OPERATING VOLTAGE

VOLTAGE	FACTOR
416V	X 0.87
440V	X 0.92
460V	X 0.96
480V	X 1.00

THE SUSTAINED CURRENT VALUE IS CONSTANT IRRESPECTIVE OF VOLTAGE LEVEL

NOTE 2
 THE FOLLOWING MULTIPLICATION FACTORS SHOULD BE USED TO CONVERT THE VALUES CALCULATED IN ACCORDANCE WITH NOTE 1 TO THOSE APPLICABLE TO THE VARIOUS TYPES OF SHORT CIRCUIT

	3 PHASE	2 PHASE L-L	1 PHASE L-N
INSTANTANEOUS	X 1.0	X 0.87	X 1.30
MINIMUM	X 1.0	X 1.80	X 3.20
SUSTAINED	X 1.0	X 1.50	X 2.50
MAX SUSTAINED DURATION	10 SEC	5 SEC	2 SEC

ALL OTHER TIMES ARE UNCHANGED

SUSTAINED SHORT CIRCUIT = 14073 Amps

FRAME LV 804 R
WINDING 12 0.8 Power Factor



RATINGS

Class - Temp Rise	Cont. F - 105/40°C				Cont. H - 125/40°C				Standby - 150/40°C				Standby - 163/27°C				
50Hz	Ir (V)	380	400	415	440	380	400	415	440	380	400	415	440	380	400	415	440
	kVA	2100	2210	2210	2075	2290	2410	2410	2265	2445	2575	2575	2420	2515	2650	2650	2490
	kW	1680	1768	1768	1660	1832	1928	1928	1812	1956	2060	2060	1936	2012	2120	2120	1992
	Efficiency (%)	95.8	95.9	96.0	96.1	95.7	95.8	95.9	96.0	95.5	95.6	95.7	95.9	95.5	95.6	95.7	95.9
	kW Input	1754	1844	1843	1728	1914	2013	2011	1887	2047	2154	2152	2019	2107	2218	2215	2077
60Hz	Ir (V)	416	440	460	480	416	440	460	480	416	440	460	480	416	440	460	480
	kVA	2385	2520	2635	2750	2600	2750	2875	3000	2780	2940	3067	3200	2860	3025	3163	3300
	kW	1908	2016	2108	2200	2080	2200	2300	2400	2224	2352	2454	2560	2288	2420	2530	2640
	Efficiency (%)	95.4	95.6	95.7	95.8	95.3	95.5	95.6	95.7	95.2	95.4	95.5	95.6	95.1	95.3	95.5	95.6
	kW Input	2000	2109	2203	2296	2182	2304	2405	2507	2336	2466	2569	2677	2405	2539	2651	2762

TYPICAL DIMENSIONS - Further arrangements available - please refer to factory

P80 R/S/T CORES

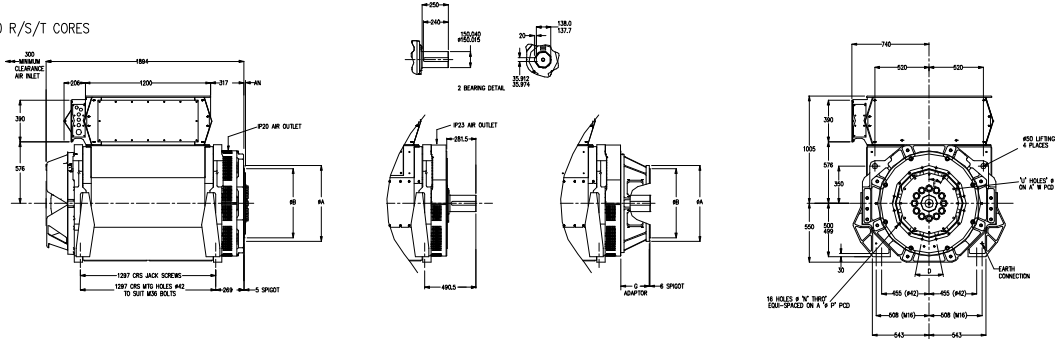

P80 R/S/T CORES 1-BRG ADAPTORS					
SAE	A	B	N	P	D
SAE 0 711	647.7	14	679.5	22.5°	
SAE 00 883	787.4	14	851.0	22.5°	

P80 R/S/T/W/X CORES 1-BRG COUPLING DISC						
SAE	AN	C	U	V	W	E
18	15.9	571.4	12	16.7	543.0	30°
21	0	673.0	12	16.7	641.5	30°
24	0	733.3	12	20.7	692.0	30°

P80 R/S/T/W/X CORES 2-BRG ADAPTORS		
SAE	G	
P80 R/S/T	0	271.5
P80 R/S/T	00	271.5
P80 W/X	0	271.5
P80 W/X	00	329.0

P80 R/S/T/W/X CORES 2-BRG ADAPTORS					
SAE	A	B	N	P	D
SAE 0 711	647.7	14	679.5	22.5°	
SAE 00 883	787.4	14	851.0	22.5°	

P80 W/X CORES

