

STAMFORD® | AvK®

MV 804 S WDG 51 - Technical Data Sheet

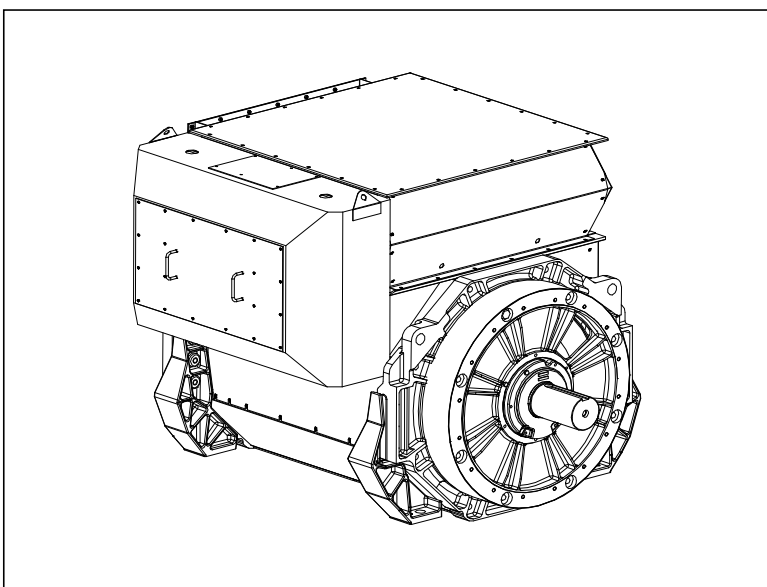

FRAME MV 804 S

STAMFORD | AvK

SPECIFICATIONS & OPTIONS

STANDARDS

Cummins Generator Technologies industrial generators meet the requirements of BS EN 60034 and the relevant sections of other national and international standards such as BS5000, VDE 0530, NEMA MG1-32, IEC60034, CSA C22.2-100, AS1359.

Other standards and certifications can be considered on request.

DESCRIPTION

The STAMFORD PI range of synchronous ac generators are brushless with a rotating field. They are separately excited by the STAMFORD Permanent Magnet Generator (PMG). This is a shaft mounted, high frequency, pilot exciter which provides a constant supply of clean power via the Automatic Voltage Regulator (AVR) to the main exciter. The main exciter output is fed to the main rotor, through a full wave bridge rectifier, protected by surge suppression.

VOLTAGE REGULATORS

The P80 range generators complete with a PMG are available with one AVR. Underspeed protection (UFRO) is also provided by the AVR. The UFRO will reduce the generator output voltage proportional to the speed of the generator below a pre-settable level.

The STAMFORD | AvK Digital Excitation Control System (DM110) is an electronic, solid-state, microprocessor based control device. The DM110 regulates the output voltage of a the ac generator by controlling the current into the generator exciter field. Input power to the DM110 is provided by a multi-pole, high-frequency, permanent magnet generator (PMG).

The DM110 is supplied in an encapsulated package designed for behind-the-panel mounting. Front panel indicators (LEDs) annunciate DM110 status and system conditions. DM110 connections are made through quarterinch, quick-connect terminals on the rear panel. A 9-pin DB-9 type connector on the rear panel provides communication between the DM110 and an IBM compatible PC.

Technical details on the DM110 are available on the Stamford-AvK website using the following URL:
<https://www.stamford-avk.com/downloads/avr-manuals>

WINDINGS & ELECTRICAL PERFORMANCE

All generator stators are wound to 2/3 pitch. This eliminates triplen (3rd, 9th, 15th ...) harmonics on the voltage waveform and is found to be the optimum design for trouble-free supply of non-linear loads. The 2/3 pitch design avoids excessive neutral currents sometimes seen with higher winding pitches. A fully connected damper winding reduces oscillations during paralleling. This winding, with the 2/3 pitch and carefully selected pole and tooth designs, ensures very low levels of voltage waveform distortion.

TERMINALS & TERMINAL BOX

Standard generators feature a main stator with 6 ends brought out to the terminals, which are mounted on the frame at the non-drive end of the generator. A sheet steel terminal box contains the AVR and provides ample space for the customers' wiring and gland arrangements. It has removable panels for easy access.

SHAFT & KEYS

All generator rotors are dynamically balanced to better than BS6861:Part 1 Grade 2.5 for minimum vibration in operation. Two bearing generators are balanced with a half key.

INSULATION/IMPREGNATION

The insulation system is class 'H'. All wound components are impregnated with materials and processes designed specifically to provide the high build required for static windings and the high mechanical strength required for rotating components.

QUALITY ASSURANCE

Generators are manufactured using production procedures having a quality assurance level to BS EN ISO 9001.

NOTE ON REGULATION

The stated voltage regulation may not be maintained in the presence of certain radio transmitted signals. Any change in performance will fall within the limits of Criteria 'B' of EN 61000-6-2:2001. At no time will the steady-state voltage regulation exceed 2%.

NB Continuous development of our products entitles us to change specification details without notice, therefore they must not be

FRAME MV 804 S WINDING 51

RATINGS	REFER TO SALES AND SERVICE BRIEFING
MAXIMUM ALTITUDE	1000 METRES ABOVE SEA LEVEL
MAXIMUM AMBIENT TEMPERATURE	40° C

CONTROL SYSTEM SERIES 3	SEPARATELY EXCITED BY P.M.G.
A.V.R.	FULL WAVE RECTIFIED
VOLTAGE REGULATION	± 0.25%
SUSTAINED SHORT CIRCUIT	REFER TO SHORT CIRCUIT DECREMENT CURVES OF THIS SECTION

INSULATION SYSTEM	CLASS H
PROTECTION	IP23 STANDARD
RATED POWER FACTOR	0.8
STATOR WINDING	DOUBLE LAYER LAP
WINDING PITCH	2/3
WINDING LEADS	6
R.F.I. SUPPRESSION	BS EN 50081/2-1/2 VDE 0875G VDE 0875N For other standards apply to the factory
WAVEFORM DISTORTION	NO LOAD < 1.5% NON-DISTORTING BALANCED LINEAR LOAD < 3.0%
MAXIMUM OVERSPEED	2250 Rev/Min
BEARING DRIVE END	ISO 6232 C3
BEARING NON DRIVE END	ISO 6324 C3
EFFICIENCY	REFER TO EFFICIENCY CURVES OF THIS SECTION

	50Hz	60Hz
FREQUENCY	50Hz	60Hz
TELEPHONE INTERFERENCE	THF< 2%	TIF<50
COOLING AIR	3 m ³ /sec	3.5 m ³ /sec
VOLTAGE STAR (Y)	3300	4160
kVA BASE RATING FOR REACTANCE VALUES	2900	3530
X _d DIRECT AXIS SYNCHRONOUS	2.900	2.500
X' _d DIRECT AXIS TRANSIENT	0.231	0.213
X'' _d DIRECT AXIS SUB-TRANSIENT	0.170	0.157
X _q QUADRATURE AXIS REACTANCE	2.000	1.840
X'' _q QUAD. AXIS SUB-TRANSIENT	0.323	0.297
X _L LEAKAGE REACTANCE	0.120	0.110
X ₂ NEGATIVE PHASE SEQUENCE	0.247	0.227
X ₀ ZERO PHASE SEQUENCE	0.039	0.036

REACTANCES ARE SATURATED		VALUES ARE PER UNIT AT RATING AND VOLTAGE INDICATED
T' _d TRANSIENT TIME CONSTANT		0.200
T'' _d SUB-TRANSIENT TIME CONSTANT		0.015
T' _{do} O.C. FIELD TIME CONSTANT		4.150
T _a ARMATURE TIME CONSTANT		0.083
SHORT CIRCUIT RATIO		1/X _d

STATOR WINDING RESISTANCE (L-N)	0.03390
ROTOR WINDING RESISTANCE	1.400
EXCITER STATOR FIELD RESISTANCE	17.50
EXCITER ROTOR RESISTANCE (L-L)	0.076
PMG STATOR RESISTANCE (L-L)	3.800
RESISTANCE VALUES ARE IN OHMS AT 20° C	

NO LOAD EXCITATION VOLTAGE	15.0
FULL LOAD EXCITATION VOLTAGE	63.0

Continuous development of our products entitles us to change specification details without notice, therefore they must not be regarded as binding.

FRAME MV 804 S WDG 51 50 Hz

THREE PHASE EFFICIENCY CURVES

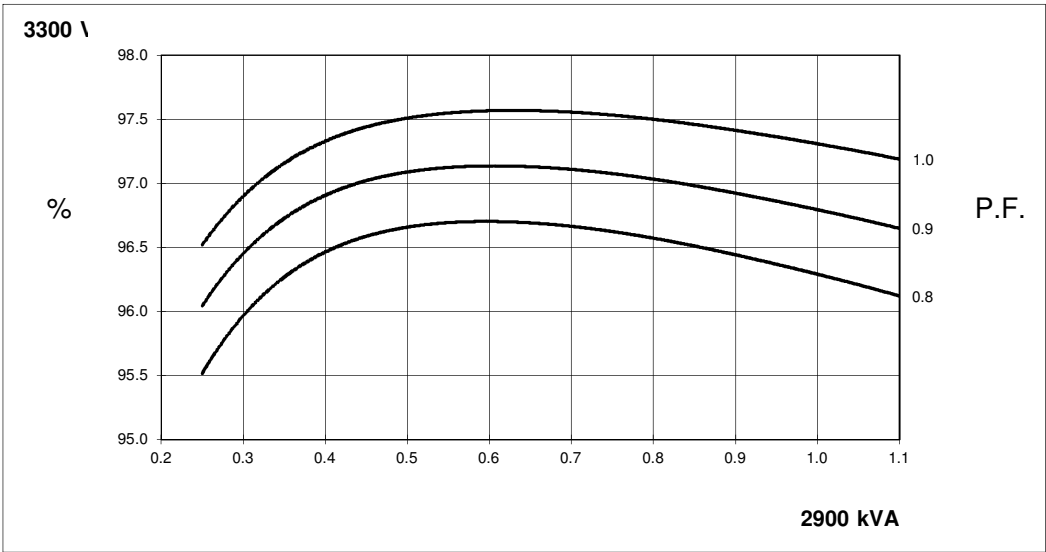

FRAME MV 804 S WDG 51 60 Hz

THREE PHASE EFFICIENCY CURVES

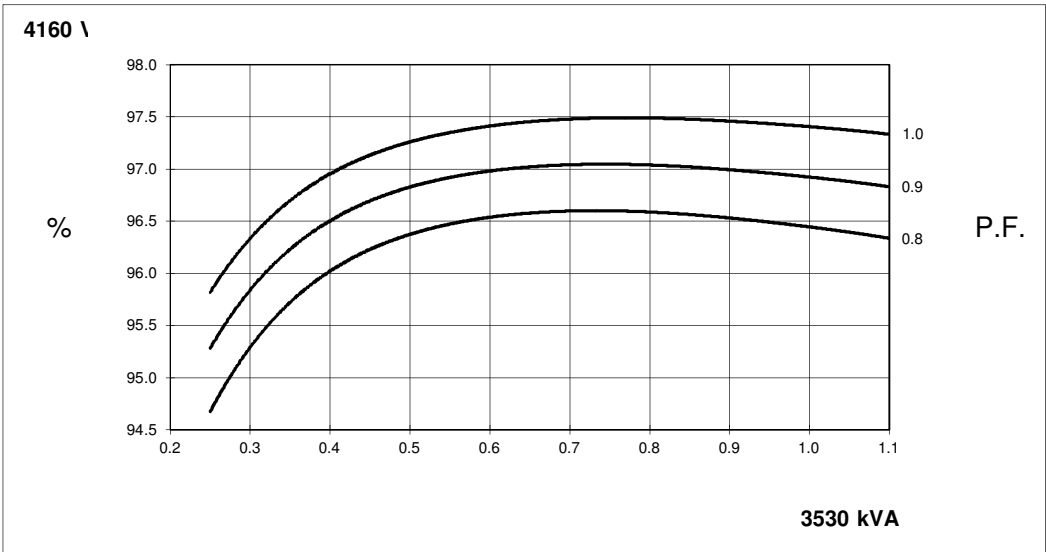

FULL WAVE RECTIFIED AVR
 LOCKED ROTOR MOTOR STARTING CURVE

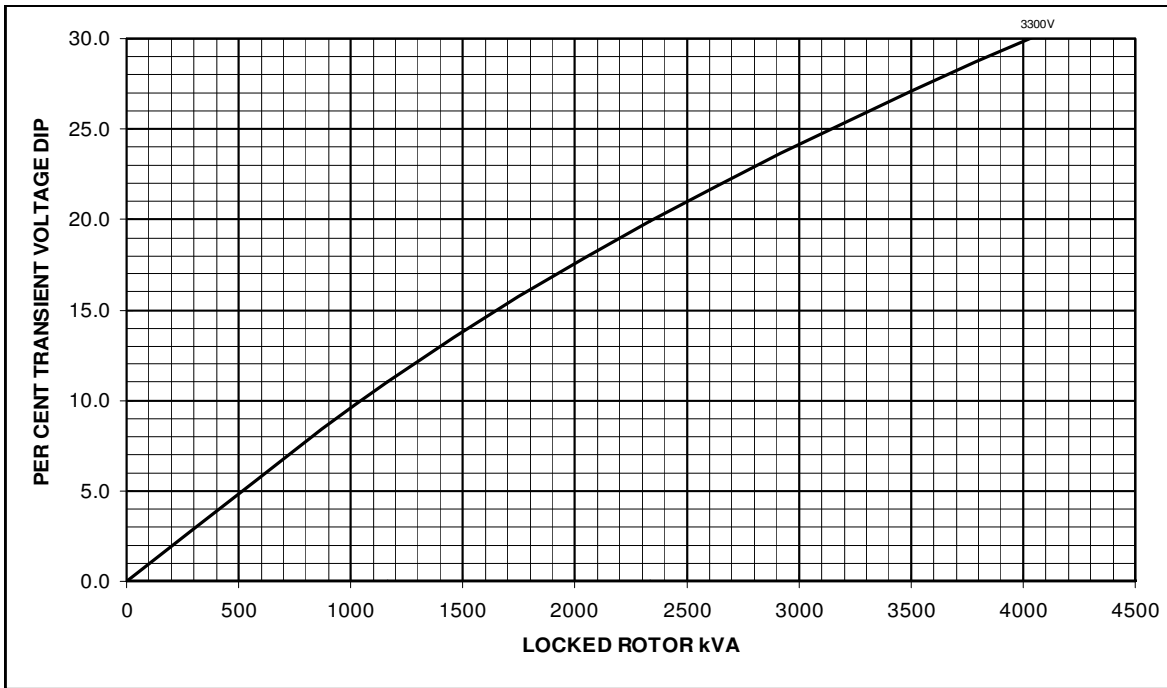

FRAME MV 804 S WDG 51 50Hz

Three Phase Short Circuit Decrement Curve
 No- Load Excitation at Rated Speed

Based on series star (wye) connection

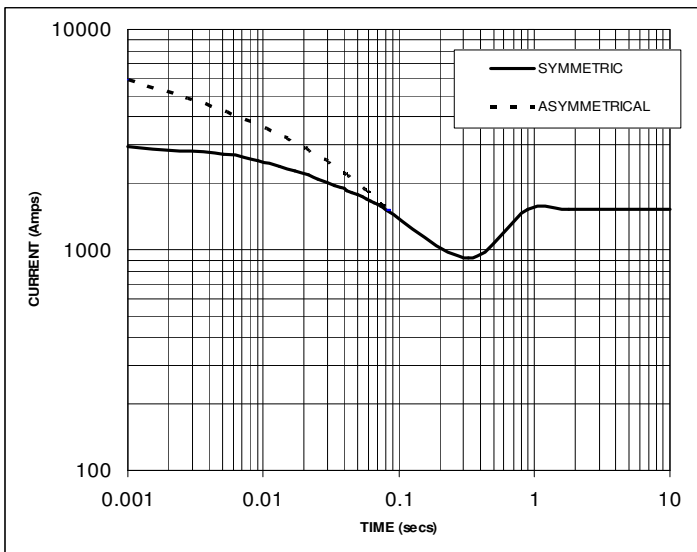

NOTE 1
 THE FOLLOWING MULTIPLICATION FACTORS SHOULD BE USED TO ADJUST THE VALUES FROM CURVES BETWEEN THE 0.001 SECONDS AND THE MINIMUM CURRENT POINT IN RESPECT OF NOMINAL OPERATING VOLTAGE

VOLTAGE	FACTOR
3300V	X 1.00

THE SUSTAINED CURRENT VALUE IS CONSTANT IRRESPECTIVE OF VOLTAGE LEVEL

NOTE 2
 THE FOLLOWING MULTIPLICATION FACTORS SHOULD BE USED TO CONVERT THE VALUES CALCULATED IN ACCORDANCE WITH NOTE 1 TO THOSE APPLICABLE TO THE VARIOUS TYPES OF SHORT CIRCUIT

	3 PHASE	2 PHASE L-L	1 PHASE L-N
INSTANTANEOUS	X 1.0	X 0.87	X 1.30
MINIMUM	X 1.0	X 1.80	X 3.20
SUSTAINED	X 1.0	X 1.50	X 2.50
MAX SUSTAINED DURATION	10 SEC	5 SEC	2 SEC

ALL OTHER TIMES ARE UNCHANGED

SUSTAINED SHORT CIRCUIT = 1522 Amps

**FULL WAVE RECTIFIED AVR
LOCKED ROTOR MOTOR STARTING CURVE**

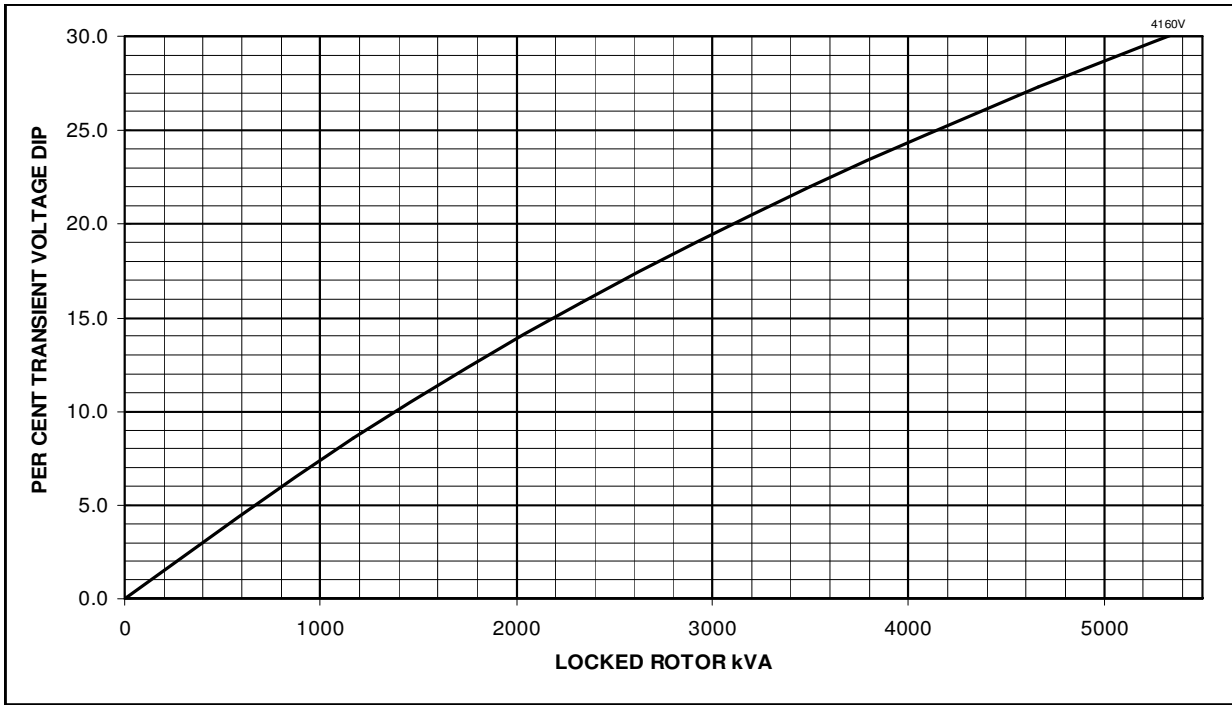

FRAME MV 804 S WDG 51 60Hz

**Three Phase Short Circuit Decrement Curve
No- Load Excitation at Rated Speed**

Based on series star (wye) connection

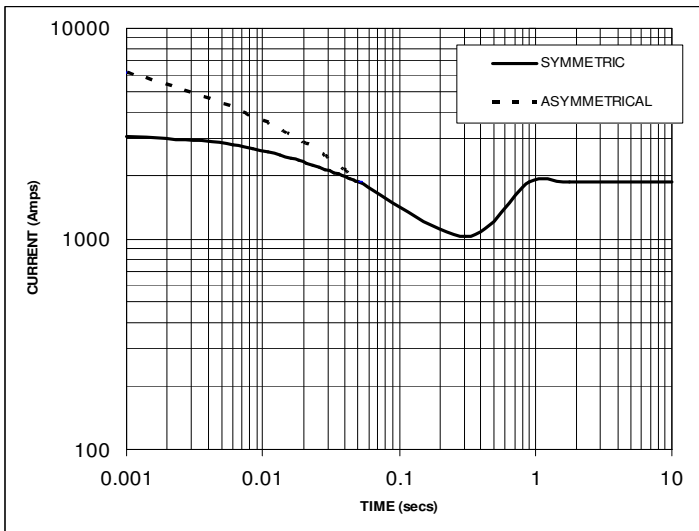

NOTE 1
THE FOLLOWING MULTIPLICATION FACTORS SHOULD BE USED TO ADJUST THE VALUES FROM CURVES BETWEEN THE 0.001 SECONDS AND THE MINIMUM CURRENT POINT IN RESPECT OF NOMINAL OPERATING VOLTAGE

VOLTAGE	FACTOR
4160V	X 1.00

THE SUSTAINED CURRENT VALUE IS CONSTANT IRRESPECTIVE OF VOLTAGE LEVEL

NOTE 2
THE FOLLOWING MULTIPLICATION FACTORS SHOULD BE USED TO CONVERT THE VALUES CALCULATED IN ACCORDANCE WITH NOTE 1 TO THOSE APPLICABLE TO THE VARIOUS TYPES OF SHORT CIRCUIT

	3 PHASE	2 PHASE L-L	1 PHASE L-N
INSTANTANEOUS	X 1.0	X 0.87	X 1.30
MINIMUM	X 1.0	X 1.80	X 3.20
SUSTAINED	X 1.0	X 1.50	X 2.50
MAX SUSTAINED DURATION	10 SEC	5 SEC	2 SEC

ALL OTHER TIMES ARE UNCHANGED

SUSTAINED SHORT CIRCUIT = 1862 Amps

FRAME MV 804 S

WINDING 51 0.8 Power Factor

STAMFORD | AvK

RATINGS

Class - Temp Rise		Cont. F - 105/40°C	Cont. H - 125/40°C	Standby - 150/40°C	Standby - 163/27°C
50	Star (V)	3300	3300	3300	3300
	kVA	2660	2900	3100	3190
	kW	2128	2320	2480	2552
	Efficiency (%)	96.4	96.3	96.2	96.1
	kW Input	2208	2409	2579	2655
60	Star (V)	4160	4160	4160	4160
	kVA	3250	3530	3775	3880
	kW	2600	2824	3020	3104
	Efficiency (%)	96.5	96.4	96.4	96.3
	kW Input	2695	2928	3134	3222

TYPICAL DIMENSIONS - Further arrangements available - please refer to factory

P80 R/S/T CORES

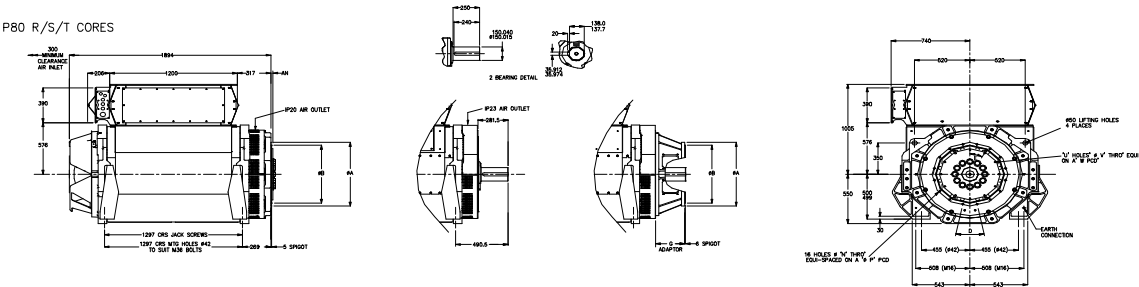

P80 R/S/T CORES 1-BRIG ADAPTORS					
SAE	A	B	N	P	D
SAE 0	711	647.7	14	679.5	22.5°
SAE 00	883	787.4	14	851.0	22.5°

P80 R/S/T/W/X CORES 1-BRIG COUPLING DISC						
SAE	AN	C	U	V	W	E
1B	15.9	571.4	12	16.7	543.0	30°
21	0	673.0	12	16.7	641.3	30°
24	0	733.3	12	20.7	692.0	30°

P80 R/S/T/W/X CORES 2-BRIG ADAPTORS	
SAE	D
P80 R/S/T	0 271.5
P80 R/S/T	00 271.5
P80 W/X	0 271.5
P80 W/X	00 329.0

P80 R/S/T/W/X CORES 2-BRIG ADAPTORS					
SAE	A	B	N	P	D
SAE 0	711	647.7	14	679.5	22.5°
SAE 00	883	787.4	14	851.0	22.5°

P80 W/X CORES

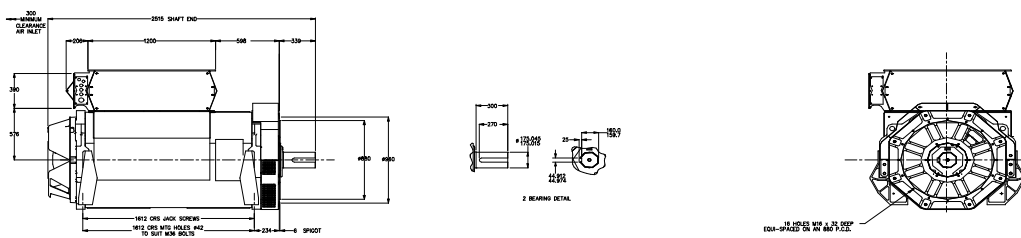

STAMFORD | AvK