

STAMFORD[®]

HCI534F/544F - Winding 14

Technical  Data Sheet

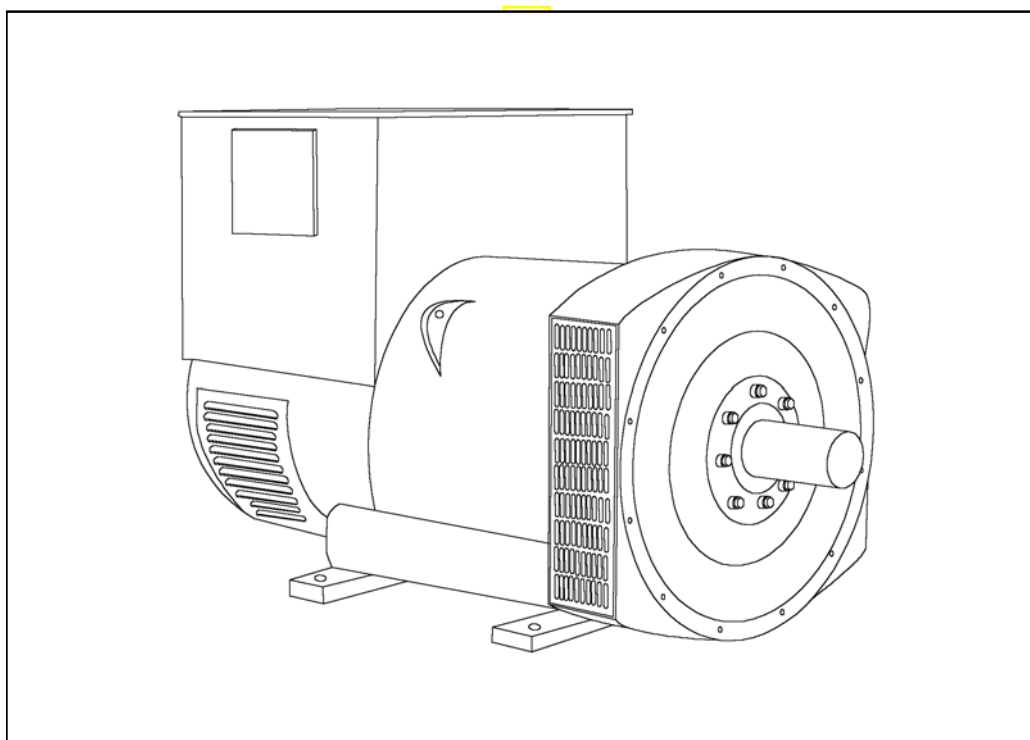

HCI534F/544F

SPECIFICATIONS & OPTIONS

STAMFORD

STANDARDS

Stamford industrial generators meet the requirements of BS EN 60034 and the relevant section of other international standards such as BS5000, VDE 0530, NEMA MG1-32, IEC34, CSA C22.2-100, AS1359. Other standards and certifications can be considered on request.

VOLTAGE REGULATORS

AS440 AVR - STANDARD

With this self-excited system the main stator provides power via the Automatic Voltage Regulator (AVR) to the exciter stator. The high efficiency semi-conductors of the AVR ensure positive build-up from initial low levels of residual voltage.

The exciter rotor output is fed to the main rotor through a three-phase full-wave bridge rectifier. The rectifier is protected by a surge suppressor against surges caused, for example, by short circuit or out-of-phase paralleling.

The AS440 will support a range of electronic accessories, including a 'droop' Current Transformer (CT) to permit parallel operation with other ac generators.

MX341 AVR

This sophisticated AVR is incorporated into the Stamford Permanent Magnet Generator (PMG) control system.

The PMG provides power via the AVR to the main exciter, giving a source of constant excitation power independent of generator output. The main exciter output is then fed to the main rotor, through a full wave bridge, protected by a surge suppressor. The AVR has in-built protection against sustained over-excitation, caused by internal or external faults. This de-excites the machine after a minimum of 5 seconds.

An engine relief load acceptance feature can enable full load to be applied to the generator in a single step.

If three-phase sensing is required with the PMG system the MX321 AVR must be used.

We recommend three-phase sensing for applications with greatly unbalanced or highly non-linear loads.

MX321 AVR

The most sophisticated of all our AVRs combines all the features of the MX341 with, additionally, three-phase rms sensing, for improved regulation and performance.

Over voltage protection is built-in and short circuit current level adjustments is an optional facility.

WINDINGS & ELECTRICAL PERFORMANCE

All generator stators are wound to 2/3 pitch. This eliminates triplen (3rd, 9th, 15th ...) harmonics on the voltage waveform and is found to be the optimum design for trouble-free supply of non-linear loads. The 2/3 pitch design avoids excessive neutral currents sometimes seen with higher winding pitches, when in parallel with the mains. A fully connected damper winding reduces oscillations during paralleling. This winding, with the 2/3 pitch and carefully selected pole and tooth designs, ensures very low waveform distortion.

TERMINALS & TERMINAL BOX

Standard generators are 3-phase reconnectable with 12 ends brought out to the terminals, which are mounted on a cover at the non-drive end of the generator. A sheet steel terminal box contains the AVR and provides ample space for the customers' wiring and gland arrangements. It has removable panels for easy access.

SHAFT & KEYS

All generator rotors are dynamically balanced to better than BS6861:Part 1 Grade 2.5 for minimum vibration in operation. Two bearing generators are balanced with a half key.

INSULATION/IMPREGNATION

The insulation system is class 'H'.

All wound components are impregnated with materials and processes designed specifically to provide the high build required for static windings and the high mechanical strength required for rotating components.

QUALITY ASSURANCE

Generators are manufactured using production procedures having a quality assurance level to BS EN ISO 9001.

The stated voltage regulation may not be maintained in the presence of certain radio transmitted signals. Any change in performance will fall within the limits of Criteria 'B' of EN 61000-6-2:2001. At no time will the steady-state voltage regulation exceed 2%.

DE RATES

All values tabulated on page 7 are subject to the following reductions

5% when air inlet filters are fitted.

3% for every 500 metres by which the operating altitude exceeds 1000 metres above mean sea level.

3% for every 5 C by which the operational ambient temperature exceeds 40 C.

Note: Requirement for operating in an ambient exceeding 60 C must be referred to the factory.

NB Continuous development of our products entitles us to change specification details without notice, therefore they must not be regarded as binding.

Front cover drawing typical of product range.

APPROVED DOCUMENT

WINDING 14

CONTROL SYSTEM	SEPARATELY EXCITED BY P.M.G.		
A.V.R.	MX341	MX321	
VOLTAGE REGULATION	± 1%	± 0.5 %	With 4% ENGINE GOVERNING
SUSTAINED SHORT CIRCUIT	REFER TO SHORT CIRCUIT DECREMENT CURVES (page 6)		

CONTROL SYSTEM	SELF EXCITED		
A.V.R.	SX440	SX421	
VOLTAGE REGULATION	± 1.0 %	± 0.5 %	With 4% ENGINE GOVERNING
SUSTAINED SHORT CIRCUIT	DOES NOT SUSTAIN A SHORT CIRCUIT CURRENT		

INSULATION SYSTEM	CLASS H		
PROTECTION	IP23		
RATED POWER FACTOR	0.8		
STATOR WINDING	DOUBLE LAYER LAP		
WINDING PITCH	TWO THIRDS		
WINDING LEADS	12		
MAIN STATOR RESISTANCE	0.0025 Ohms PER PHASE AT 22°C STAR CONNECTED		
MAIN ROTOR RESISTANCE	2.16 Ohms at 22°C		
EXCITER STATOR RESISTANCE	17 Ohms at 22°C		
EXCITER ROTOR RESISTANCE	0.092 Ohms PER PHASE AT 22°C		
R.F.I. SUPPRESSION	BS EN 61000-6-2 & BS EN 61000-6-4, VDE 0875G, VDE 0875N. refer to factory for others		
WAVEFORM DISTORTION	NO LOAD < 1.5% NON-DISTORTING BALANCED LINEAR LOAD < 5.0%		
MAXIMUM OVERSPEED	2250 Rev/Min		
BEARING DRIVE END	BALL. 6220 (ISO)		
BEARING NON-DRIVE END	BALL. 6314 (ISO)		

	1 BEARING	2 BEARING	
WEIGHT COMP. GENERATOR	1685 kg	1694 kg	
WEIGHT WOUND STATOR	805 kg	805 kg	
WEIGHT WOUND ROTOR	684 kg	655 kg	
WR ² INERTIA	10.033 kgm ²	9.7551 kgm ²	
SHIPPING WEIGHTS in a crate	1775 kg	1780 kg	
PACKING CRATE SIZE	166 x 87 x 124(cm)	166 x 87 x 124(cm)	
TELEPHONE INTERFERENCE	THF<2%	TIF<50	
COOLING AIR	1.312 m ³ /sec 2780 cfm		
VOLTAGE STAR	380	400	416
kVA BASE RATING FOR REACTANCE VALUES	825	825	825
X _d DIR. AXIS SYNCHRONOUS	3.11	2.80	2.60
X' _d DIR. AXIS TRANSIENT	0.14	0.13	0.12
X'' _d DIR. AXIS SUBTRANSIENT	0.10	0.09	0.08
X _q QUAD. AXIS REACTANCE	2.49	2.24	2.08
X'' _q QUAD. AXIS SUBTRANSIENT	0.29	0.26	0.24
X _L LEAKAGE REACTANCE	0.06	0.05	0.05
X ₂ NEGATIVE SEQUENCE	0.20	0.18	0.17
X ₀ ZERO SEQUENCE	0.09	0.08	0.07

REACTANCES ARE SATURATED

VALUES ARE PER UNIT AT RATING AND VOLTAGE INDICATED

T' _d TRANSIENT TIME CONST.	0.08s
T'' _d SUB-TRANSTIME CONST.	0.012s
T' _{do} O.C. FIELD TIME CONST.	2.5s
T _a ARMATURE TIME CONST.	0.019s
SHORT CIRCUIT RATIO	1/X _d

HCI534F/544F
Winding 14

STAMFORD

THREE PHASE EFFICIENCY CURVES

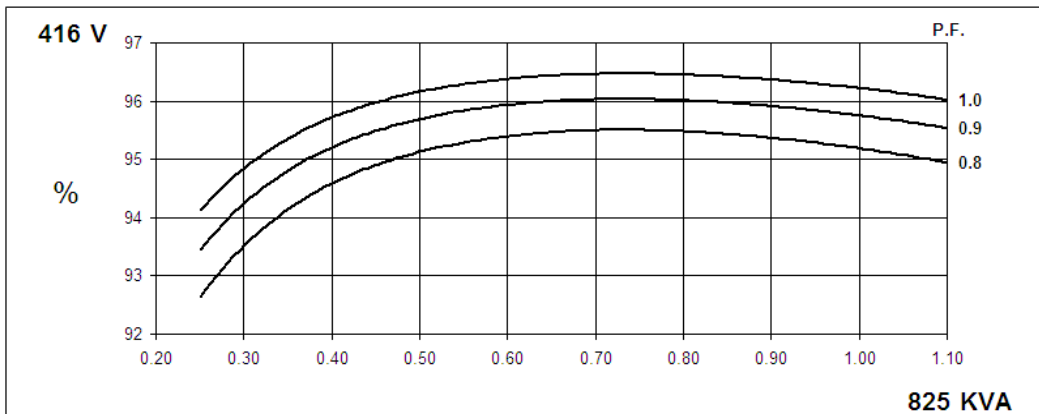
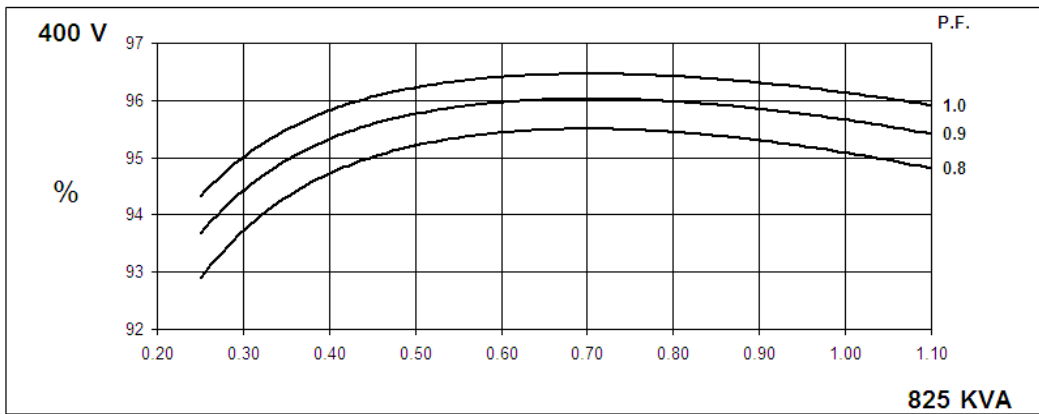
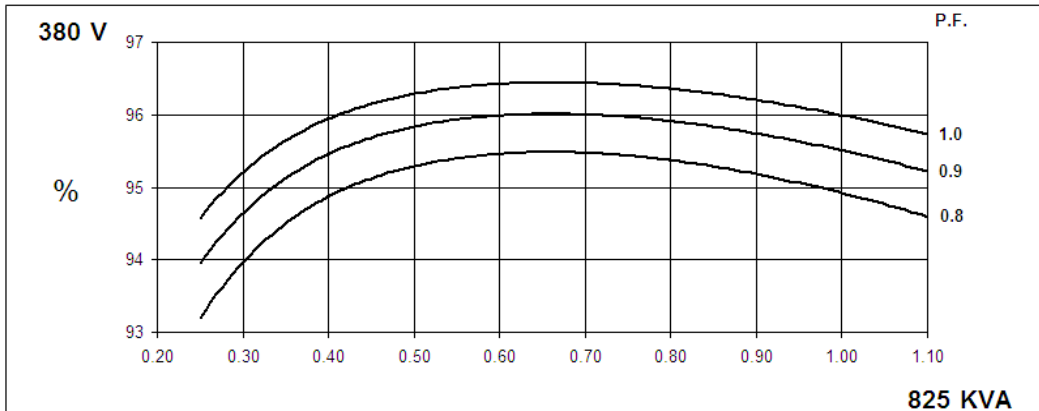

HCI534F/544F
Winding 14

STAMFORD

SX

Locked Rotor Motor Starting Curves

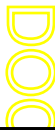
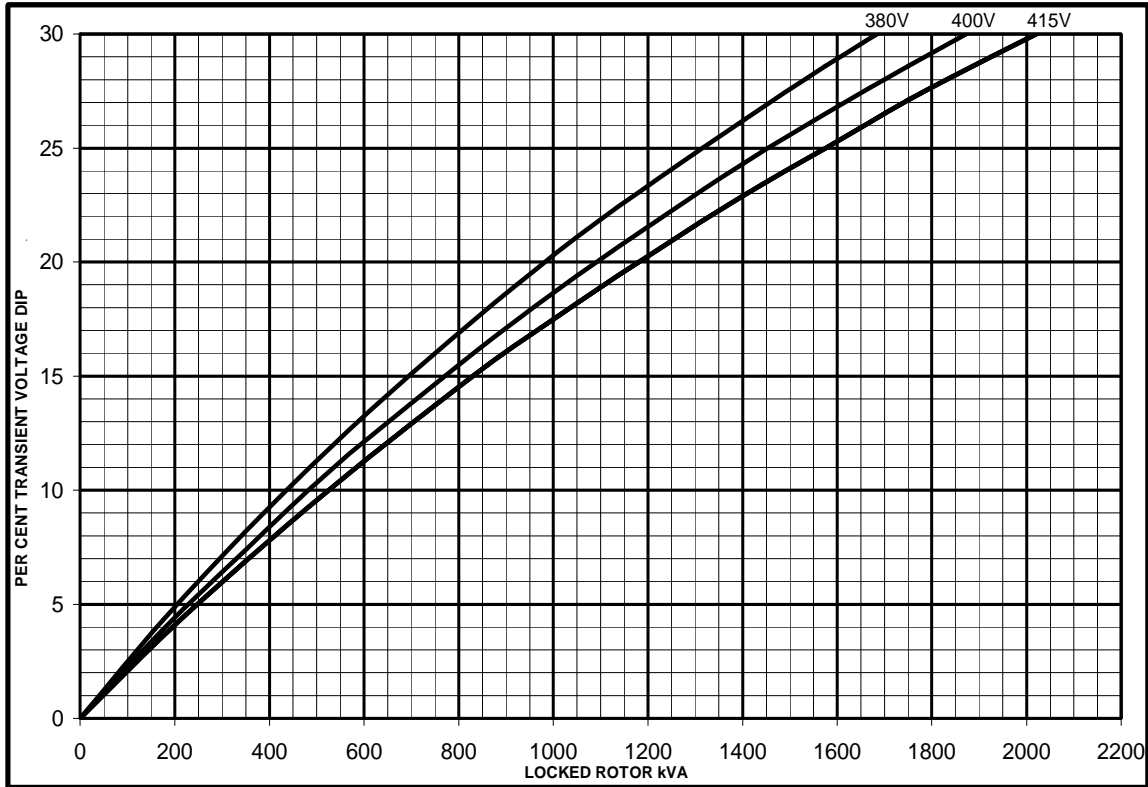

MX

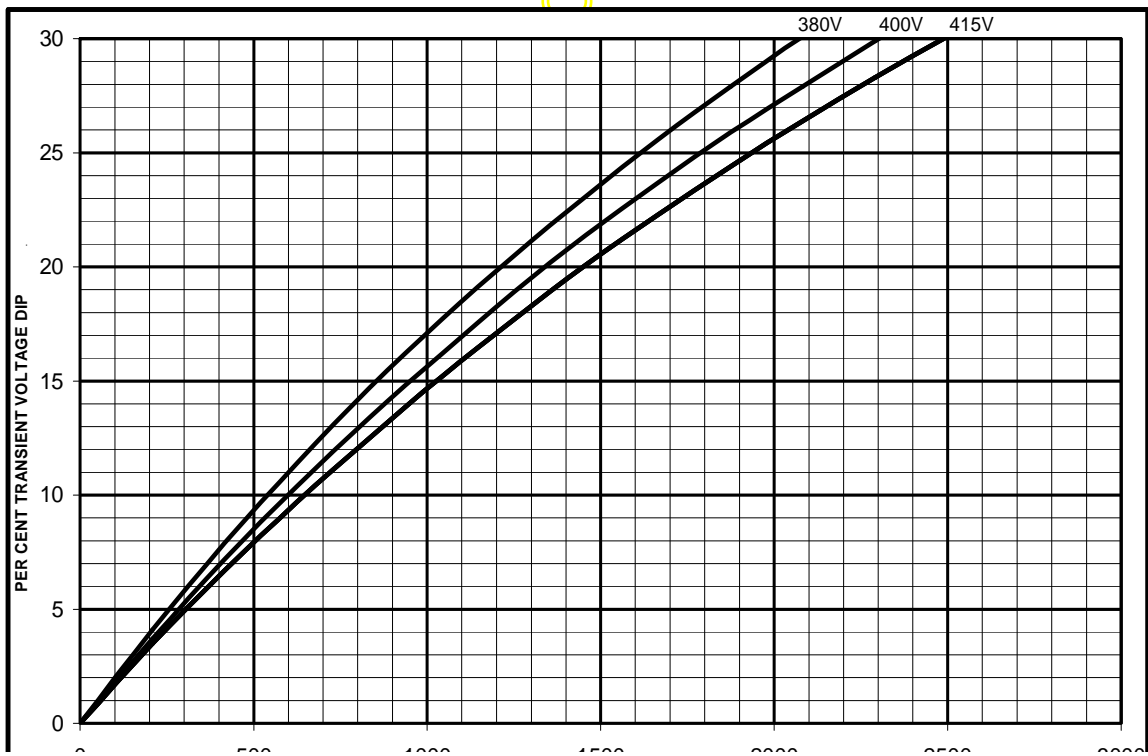

**Three-phase Short Circuit Decrement Curve. No-load Excitation at Rated Speed
Based on star (wye) connection.**

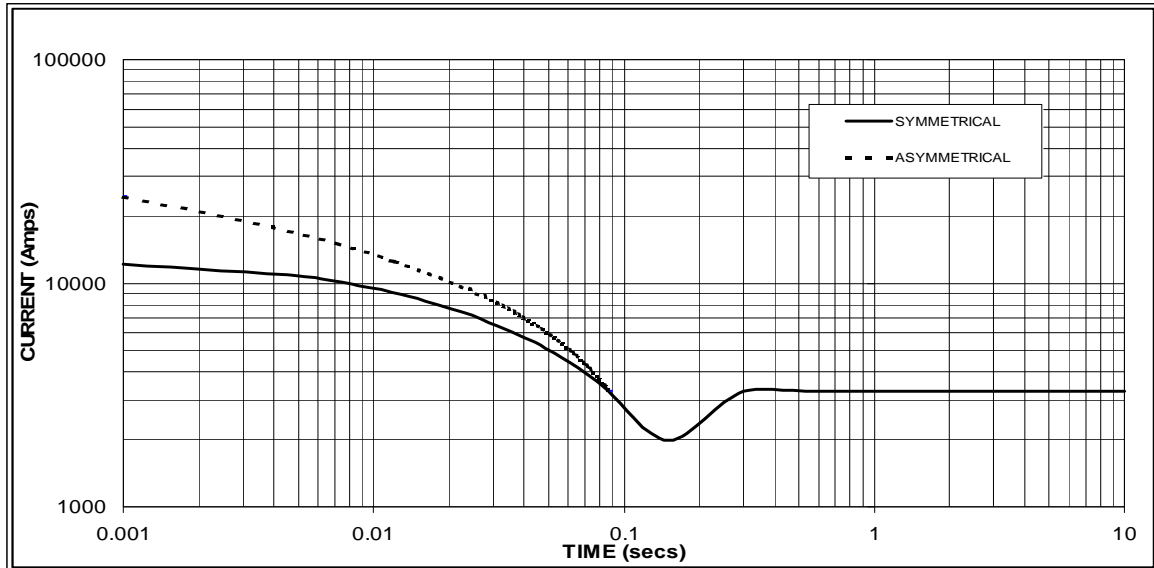

Sustained Short Circuit = 3300 Amps

Note 1

The following multiplication factors should be used to adjust the values from curve between time 0.001 seconds and the minimum current point in respect of nominal operating

Voltage	Factor
380V	X 1.00
400V	X 1.05
416V	X 1.09

The sustained current value is constant irrespective of voltage level

Note 2

The following multiplication factor should be used to convert the values calculated in accordance with NOTE 1 to those applicable to the various types of short circuit :

	3-phase	2-phase L-L	1-phase L-N
Instantaneous	x 1.00	x 0.87	x 1.30
Minimum	x 1.00	x 1.80	x 3.20
Sustained	x 1.00	x 1.50	x 2.50
Max. sustained duration	10 sec.	5 sec.	2 sec.

All other times are unchanged

HCI534F/544F
Winding 14 / 0.8 Power Factor

60Hz

RATINGS

Class - Temp Rise	Cont. F - 105/40°C			Cont. H - 125/40°C			Standby - 150/40°C			Standby - 163/27°C		
Series Star (V)	380	400	416	380	400	416	380	400	416	380	400	416
Parallel StarStar (V)	190	200	208	190	200	208	190	200	208	190	200	208
Series Delta (V)	220	230	240	220	230	240	220	230	240	220	230	240
kVA	750	750	750	825	825	825	875	875	875	906	906	906
kW	600	600	600	660	660	660	700	700	700	725	725	725
Efficiency (%)	95.2	95.3	95.4	94.9	95.1	95.2	94.7	94.9	95.0	94.6	94.8	94.9
kW Input	631	630	629	695	694	693	739	737	737	766	765	763

APPROVED

DIMENSIONS

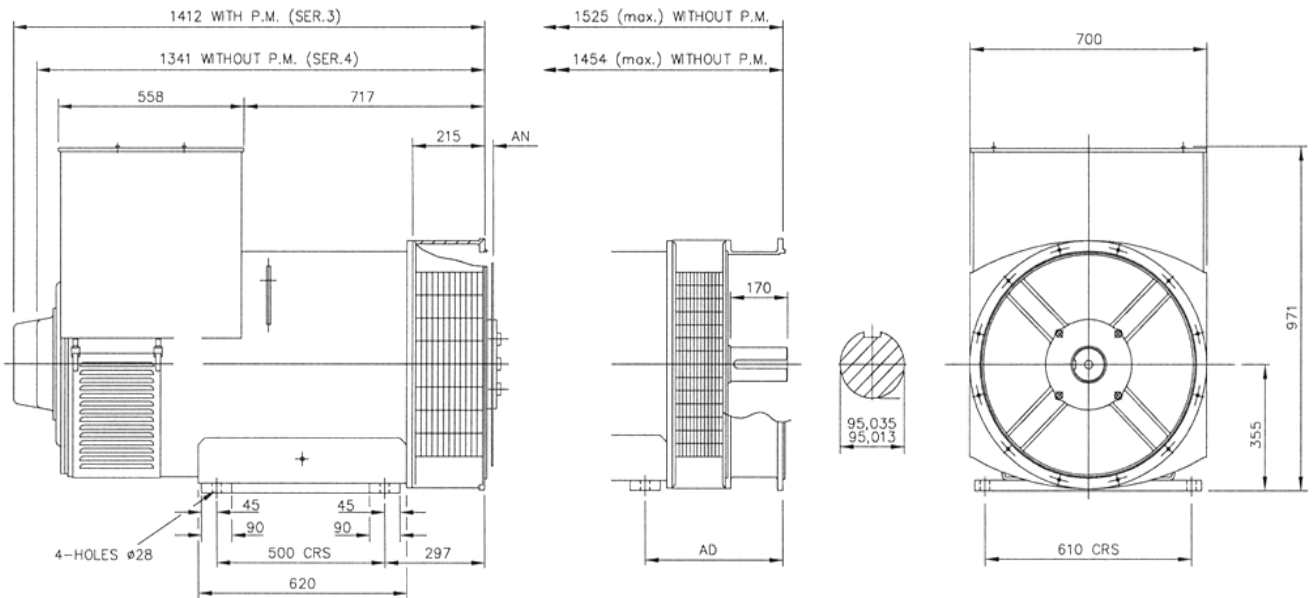

COUPLING DISC	AN
SAE 14	25,4
SAE 18	13,87
SAE 21	0

ADAPTOR	AD
SAE 00	410
SAE 0	410
SAE 1/2	390
SAE 1	390

APPROVED DOCUMENT

STAMFORD

Head Office Address:
Barnack Road, Stamford
Lincolnshire, PE9 2NB
United Kingdom
Tel: +44 (0) 1780 484000
Fax: +44 (0) 1780 484100

www.cumminsgeneratortechnologies.com

Copyright 2010, Cummins Generator Technologies Ltd, All Rights Reserved
Stamford and AvK are registered trade marks of Cummins Generator Technologies Ltd
Cummins and the Cummins logo are registered trade marks of Cummins Inc.