

TABULATION							
PART NO.	CORE	DIM "A"	DIM "B"	DIM "C"	DIM "D"	C OF G	WEIGHT(Kg)
A077F855	G	673.5	568.5	314.3	269	284	178
A077G693	H	673.5	568.5	314.3	269	279	183
A077G694	J	673.5	568.5	314.3	269	272	191
A077G695	K	693.5	588.5	334.3	289	284	200
A077G696	N	713.5	608.5	354.3	309	291	216
A077G697	R	733.5	628.5	374.3	329	300	233
A077G698	Y	803.5	698.5	444.3	399	331	263

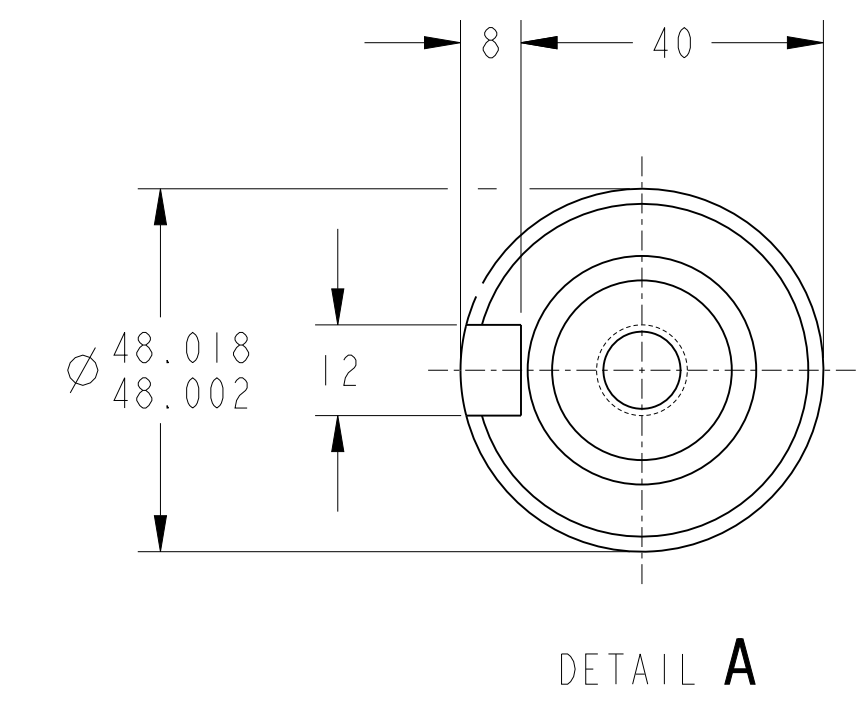
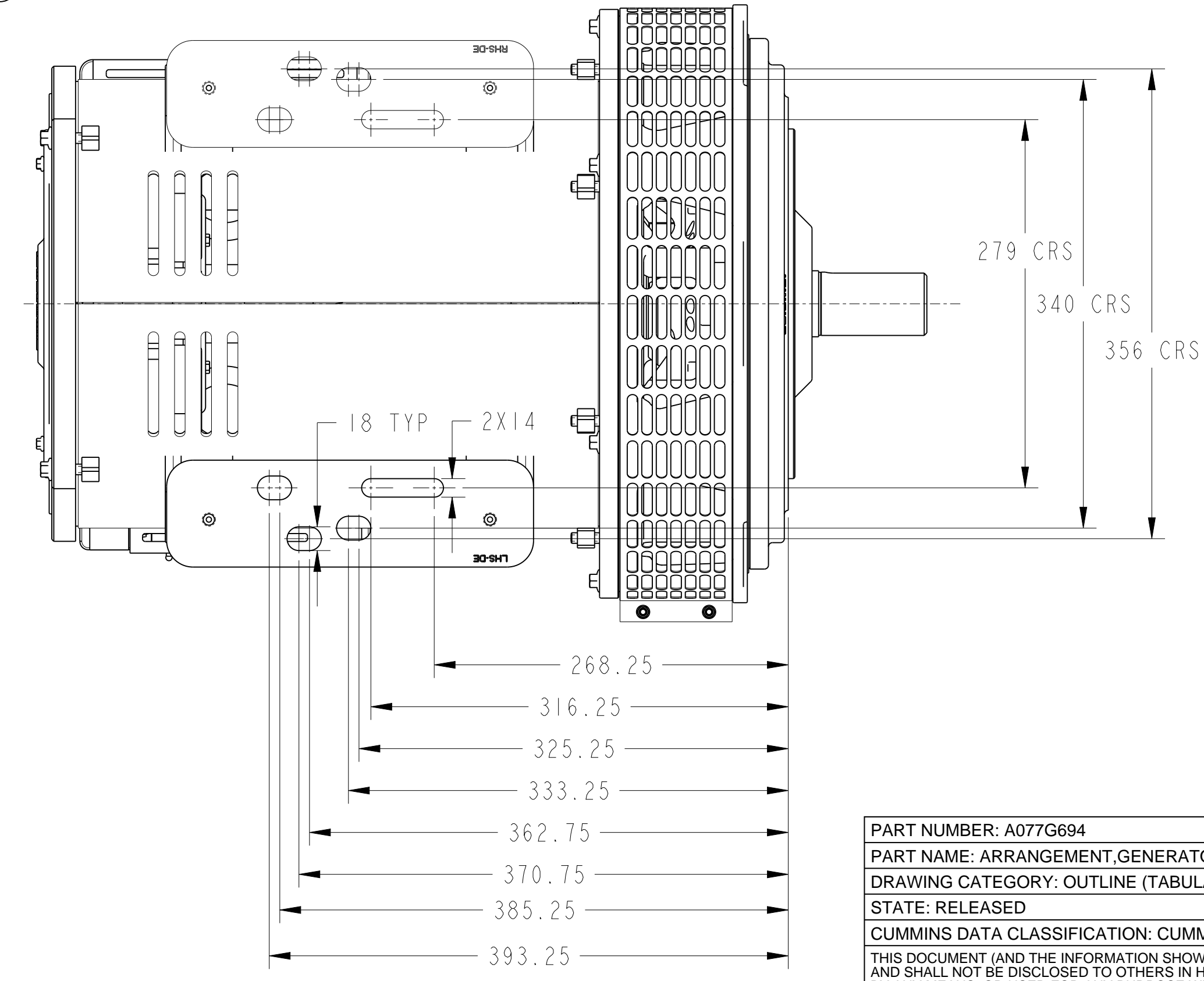
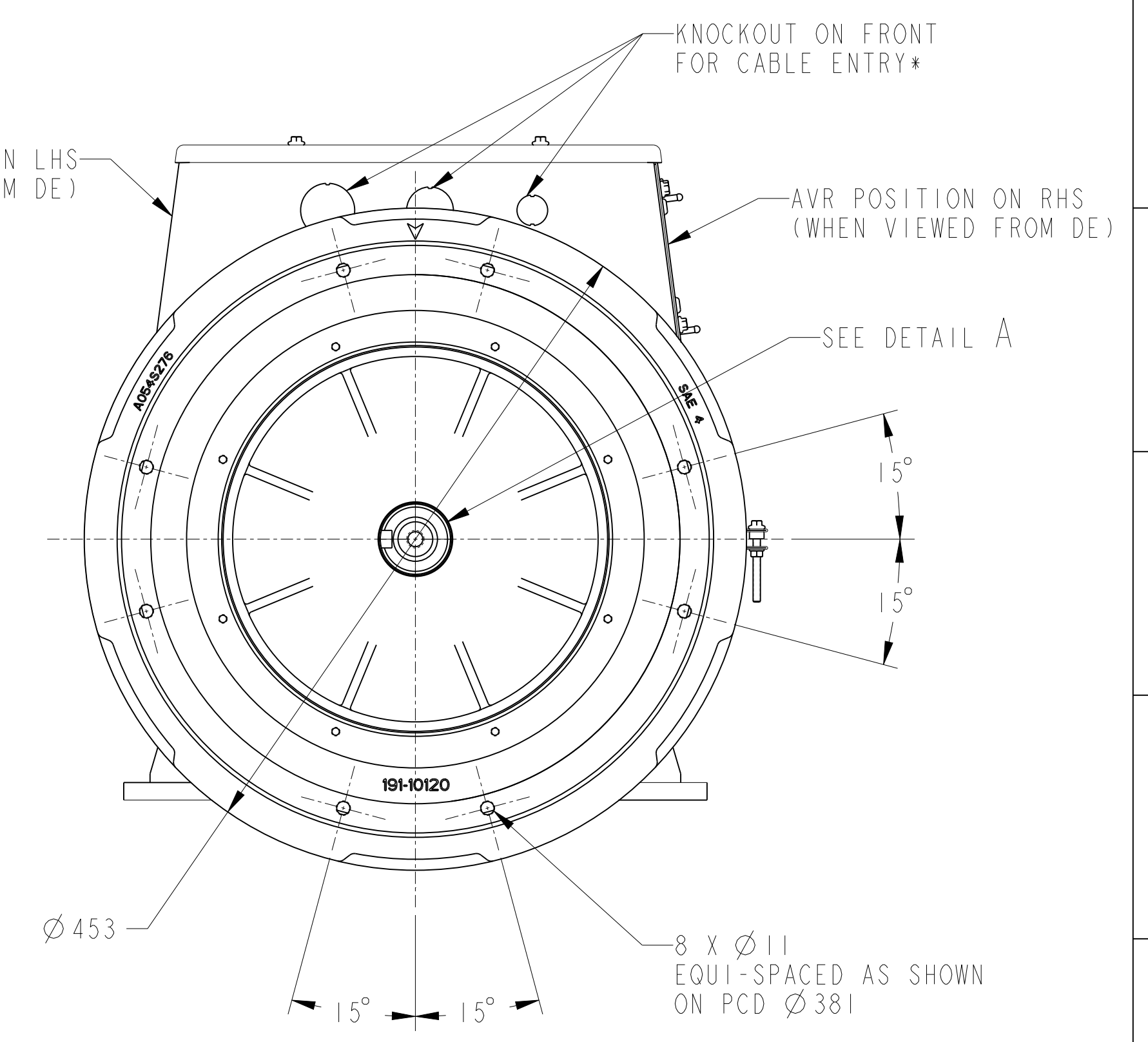
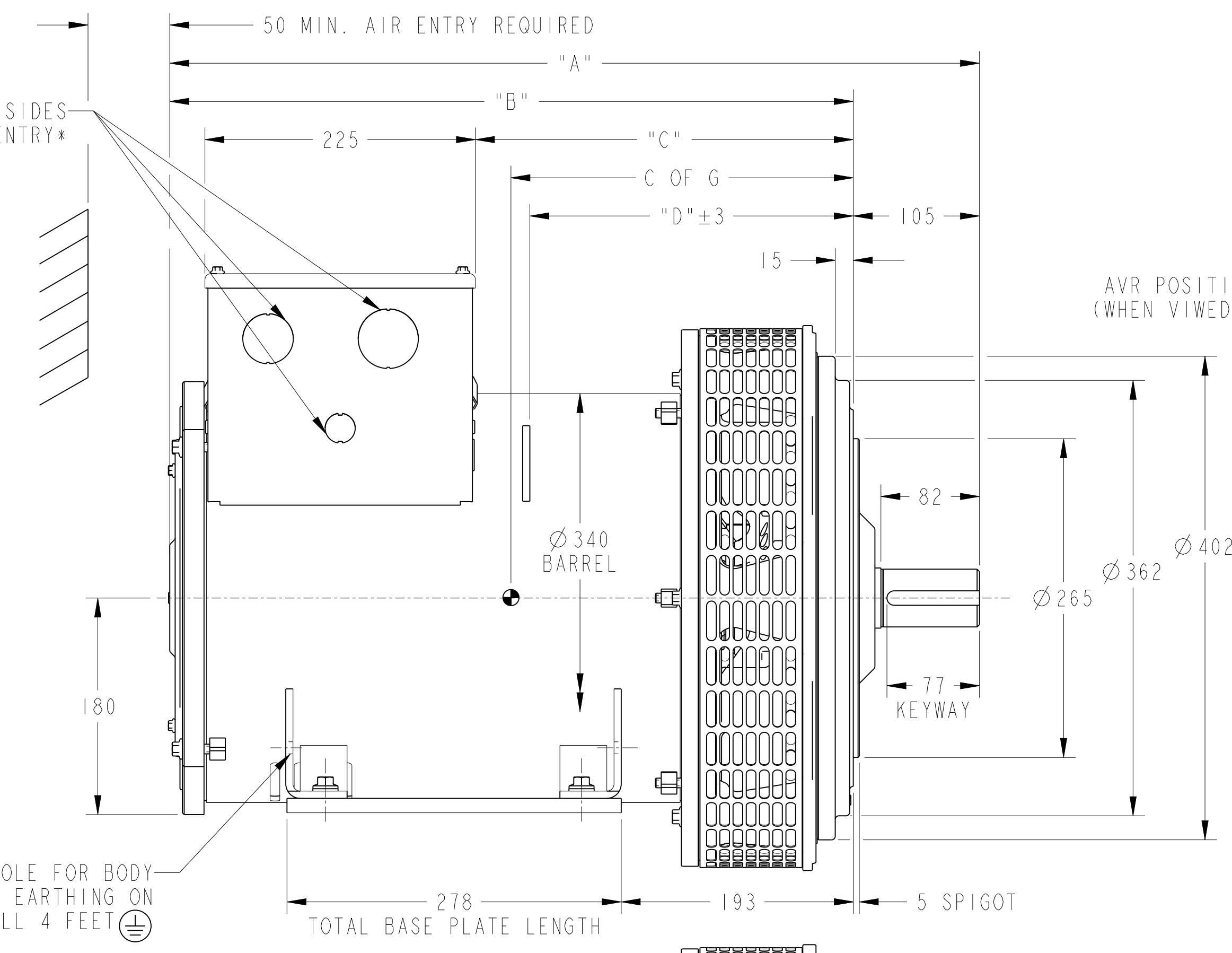
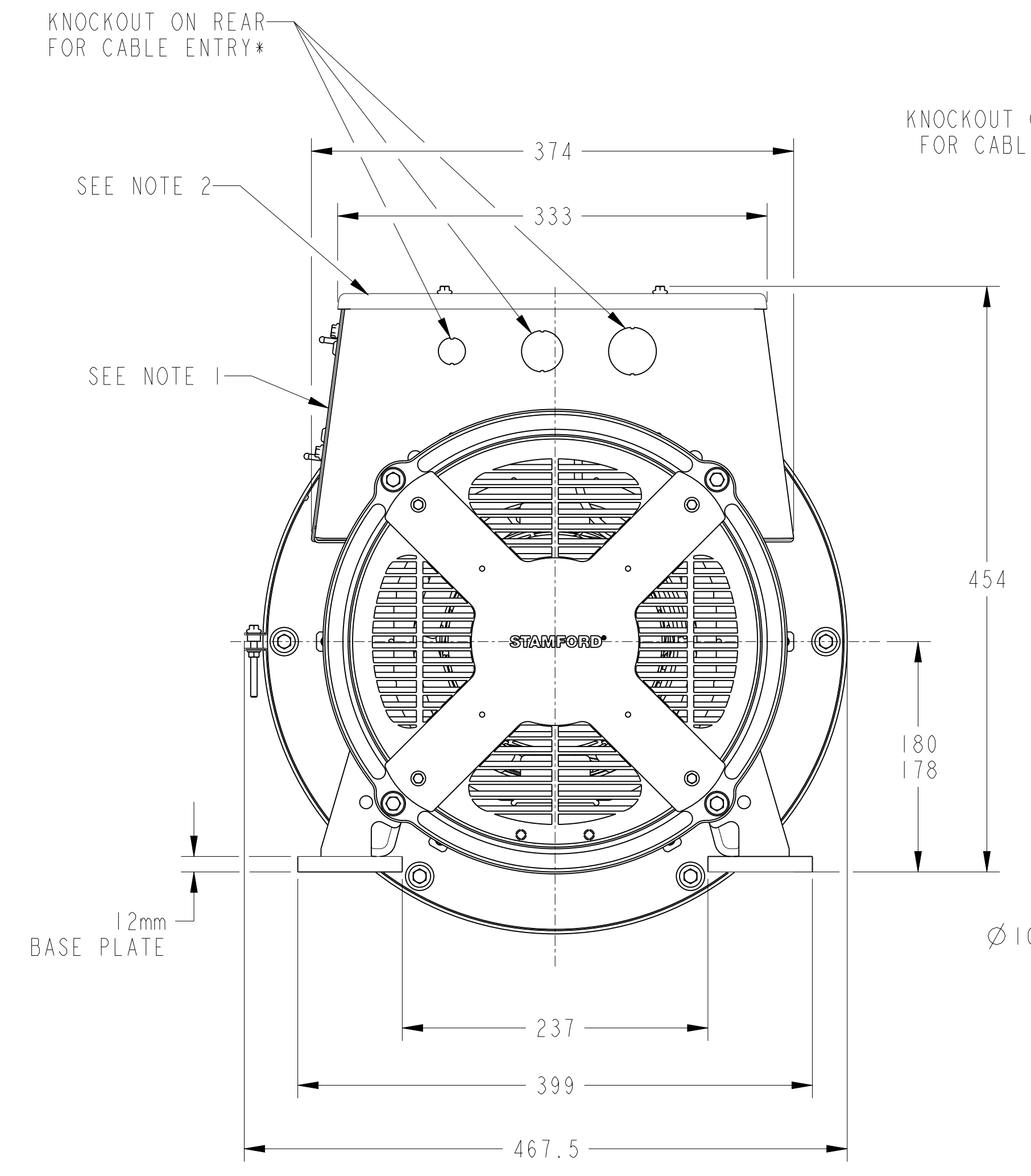
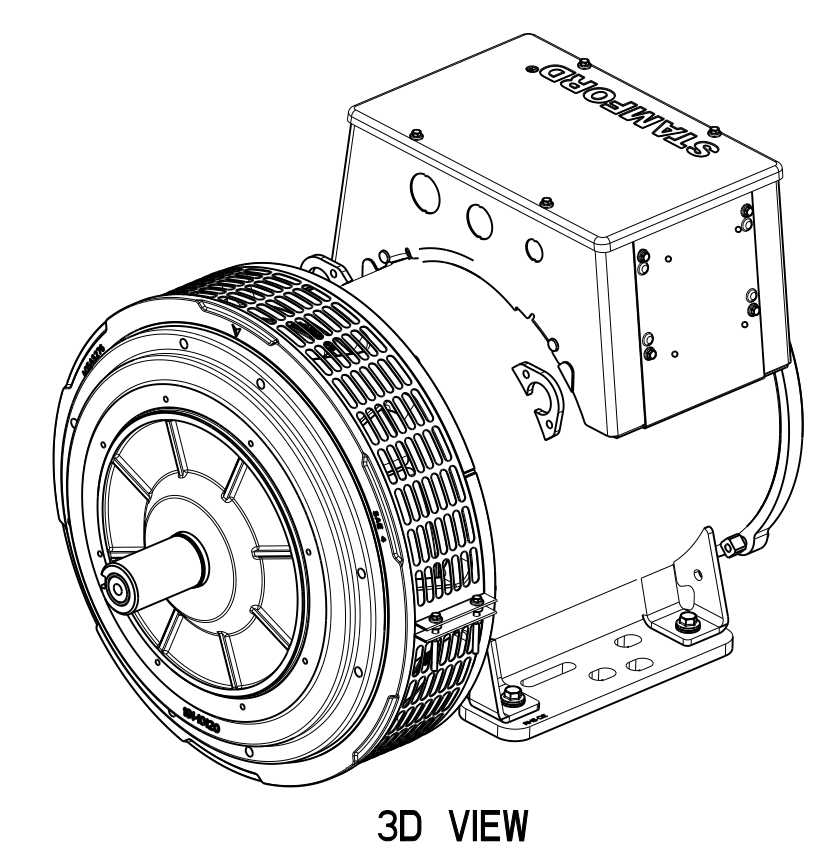

- NOTES:
1. REMOVABLE COVER FOR ACCESS TO AVR
 2. REMOVABLE COVER FOR ACCESS TO MAIN TERMINALS
 3. * FOR KNOCKOUT DETAILS REFER TERMINAL BOX DRAWING
 4. CUSTOMER MUST ENSURE THAT AIR INLET & OUTLET POSITIONS ARE NOT OBSTRUCTED

PART NUMBER: A077G694	PART REVISION: A
PART NAME: ARRANGEMENT_GENERATOR GENERAL	
DRAWING CATEGORY: OUTLINE (TABULATION)	
STATE: RELEASED	SHEET: 1 OF 2
CUMMINS DATA CLASSIFICATION: CUMMINS CONFIDENTIAL	
THIS DOCUMENT (AND THE INFORMATION SHOWN THEREON) IS CONFIDENTIAL AND PROPRIETARY AND SHALL NOT BE DISCLOSED TO OTHERS IN HARD COPY OR ELECTRONIC FORM, REPRODUCED BY ANY MEANS, OR USED FOR ANY PURPOSE WITHOUT WRITTEN CONSENT OF CUMMINS INC.	

DRAWING SPECIFICATION DESCRIPTION			
SIL2, 2B, 4P, NO ADAPTER			
Cummins Generator Technologies		SIZE: A1	SCALE: 1:6
DIMENSIONS ARE IN: MILLIMETERS		[] ARE IN: -	
DIMENSIONING AND TOLERANCING PER: ASME Y14.5-2009		THIRD ANGLE PROJECTION	
CAD SYSTEM		PTC® Creo® Parametric	

4

3

2

1

D



Part Number: A077G694

Change Notice	CN00158855	Alternates	
Manufacturer Part (MEP)	No	Usage	Production Only
Release Phase Code	Production (P)	Drawing Specification	Number: DS47159607
External Regulations	No External Regulation		Revision: A

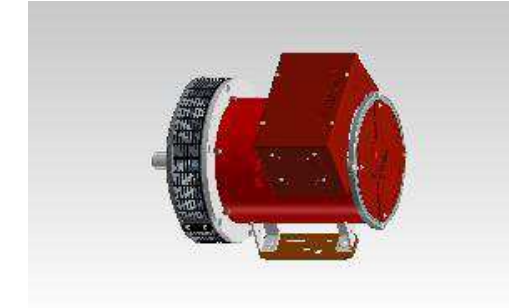

3D image provided when available for visual reference only.

C

Drawing Revision Information

Description of Change(s) Note: Change information is provided for reference only and does not supersede the drawing's primary content.
SEE CHANGE NOTICE.
PRODUCTION RELEASE

Drawing Authorization

Drafter	Aishwarya Rajaram Shelar	Date	21MAR2025
Checker	Kuldeep Dilip Pawar	Date	21MAR2025
Approver	Alin Dumitru Visian	Date	25MAR2025

B

A

Cummins Data Classification: **Cummins Confidential** This document (and the information shown thereon) is **Confidential and Proprietary** and shall not be disclosed to others in hard copy or electronic form, reproduced by any means, or used for any purpose without written consent of Cummins Inc.

Part Number: **A077G694** Part Revision: **A**
 Part Name: **ARRANGEMENT,GENERATOR GENERAL**
 Drawing Category: **Outline (Tabulation)** State: **Released** Sheet 2 of 2

4

3

2

1