

TABULATION							
PART NO.	CORE	DIM 'A'	DIM 'B'	DIM 'C'	DIM 'D'	C OF G	WEIGHT(Kg)
A077D184	D	526.4	434.4	241	185	222	79
A077N535	H	561.4	469.4	276	220	243	88
A077N536	J	561.4	469.4	276	220	239	89
A077N537	L	606.4	514.4	321	265	271	98
A077D398	P	606.4	514.4	321	265	261	103
A077N538	S	606.4	514.4	321	265	258	104

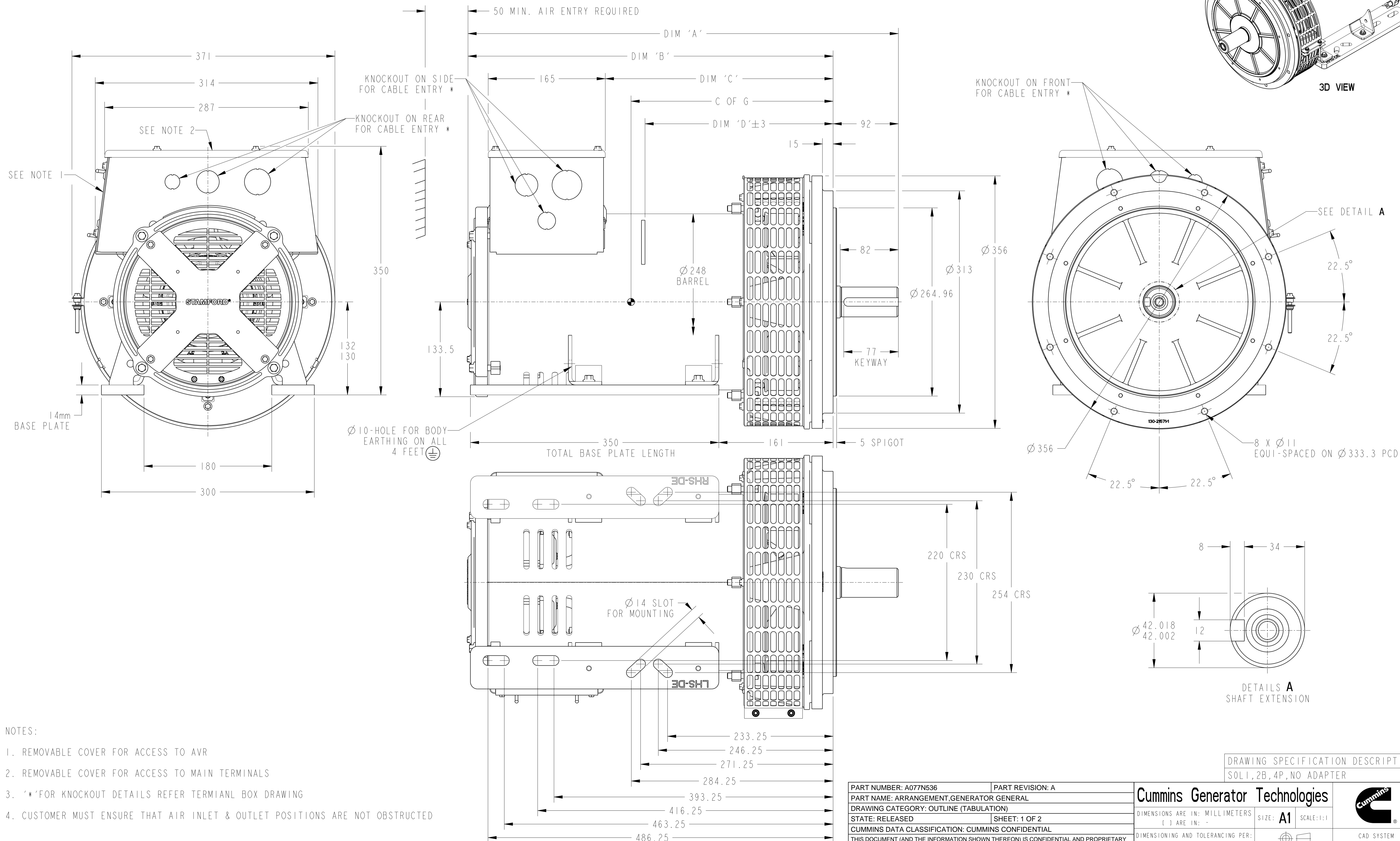
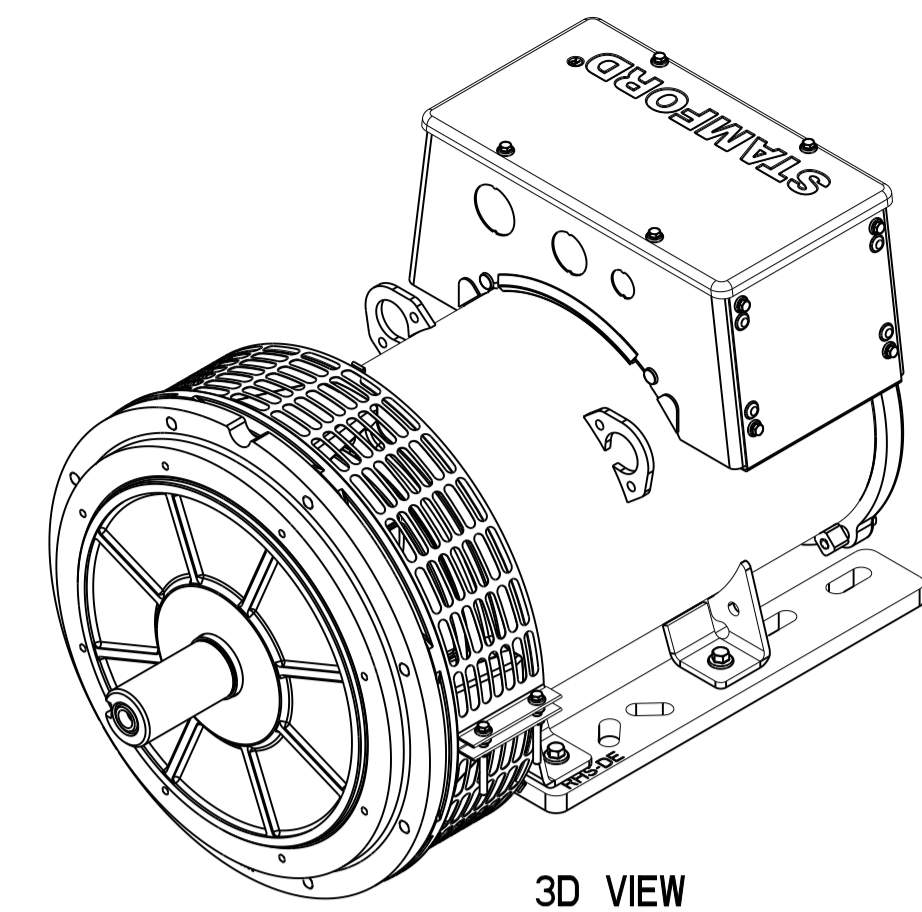

4

3

2

1

D



Part Number: A077N536

Change Notice	CN00159782	Alternates	
Manufacturer Part (MEP)	No	Usage	Production Only
Release Phase Code	Production (P)	Drawing Specification	Number: DS47158812
External Regulations	No External Regulation		Revision: A

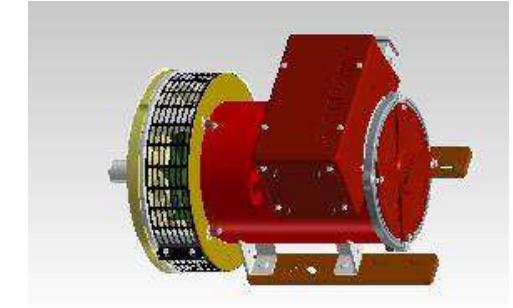

3D image provided when available for visual reference only.

C

Drawing Revision Information

<b>Description of Change(s)</b> Note: Change information is provided for reference only and does not supersede the drawing's primary content.
SEE CHANGE NOTICE.
PRODUCTION RELEASE

Drawing Authorization

Drafter	Aishwarya Rajaram Shelar	Date	20MAR2025
Checker	Kuldeep Dilip Pawar	Date	21MAR2025
Approver	Alin Dumitru Visian	Date	25MAR2025

B

A

Cummins Data Classification: **Cummins Confidential** This document (and the information shown thereon) is **Confidential and Proprietary** and shall not be disclosed to others in hard copy or electronic form, reproduced by any means, or used for any purpose without written consent of Cummins Inc.

Part Number: **A077N536** Part Revision: **A**  
 Part Name: **ARRANGEMENT,GENERATOR GENERAL**  
 Drawing Category: **Outline (Tabulation)** State: **Released** Sheet 2 of 2

4

3

2

1