

STAMFORD®

S5L1S-C4 Wdg.27 - Technical Data Sheet

Standards

STAMFORD industrial alternators meet the requirements of the relevant parts of the IEC EN 60034 and the relevant section of other international standards such as BS5000, VDE 0530, NEMA MG1-32, IEC34, CSA C22.2-100 and AS1359. Other standards and certifications can be considered on request.

Quality Assurance

Alternators are manufactured using production procedures having a quality assurance level to BS EN ISO 9001.

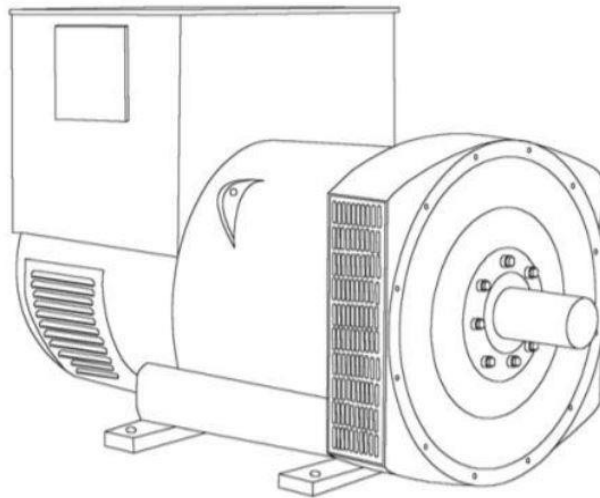

Excitation and Voltage Regulators

Excitation System					
AVR Type	AS440	MX341	MX321		
Voltage Regulation	± 1%	± 1%	± 0.5%		with 4% Engine Governing
AVR Power	Self-Excited	PMG	PMG		

No Load Excitation Voltage (V)	9.52
No Load Excitation Current (A)	0.56
Full Load Excitation Voltage (V)	41.08
Full Load Excitation Current (A)	2.24
Exciter Time Constant (seconds)	0.099

STAMFORD

S5L1S-C4 Wdg.27

Electrical Data		
Insulation System	H	
Stator Winding	Double Layer Lap	
Winding Pitch	2/3	
Winding Leads	12	
Winding Number	27	
Number of Poles	4	
IP Rating	IP23	
RFI Suppression	BS EN 61000-6-2 & BS EN 61000-6-4, VDE 0875G, VDE 0875N. Refer to factory for others	
Waveform Distortion	NO LOAD < 1.5% NON-DISTORTING BALANCED LINEAR LOAD < 5.0%	
Short Circuit Ratio	1/Xd	
Steady State X/R Ratio	13.96	
60 Hz		
Telephone Interference	TIF<50	
Cooling Air Flow	1.312 m ³ /sec	
Voltage Series Star (V)	660	690
Voltage Parallel Star (V)	330	345
Voltage Series Delta (V)	380	400
kVA Base Rating (Class H) for Reactance Values (kVA)	550	550
Saturated Values in Per Unit at Base Ratings and Voltages		
Xd Dir. Axis Synchronous	3.22	2.95
X'd Dir. Axis Transient	0.14	0.13
X''d Dir. Axis Subtransient	0.11	0.10
Xq Quad. Axis Reactance	2.55	2.33
X''q Quad. Axis Subtransient	0.28	0.26
XL Stator Leakage Reactance	0.07	0.06
X2 Negative Sequence Reactance	0.20	0.18
X0 Zero Sequence Reactance	0.09	0.08
Unsaturated Values in Per Unit at Base Ratings and Voltages		
Xd Dir. Axis Synchronous	3.87	3.54
X'd Dir. Axis Transient	0.16	0.15
X''d Dir. Axis Subtransient	0.13	0.12
Xq Quad. Axis Reactance	2.62	2.40
X''q Quad. Axis Subtransient	0.34	0.31
XL Stator Leakage Reactance	0.07	0.07
Xlr Rotor Leakage Reactance	0.10	0.09
X2 Negative Sequence Reactance	0.24	0.22
X0 Zero Sequence Reactance	0.10	0.09

STAMFORD®

S5L1S-C4 Wdg.27

Time Constants (Seconds)		
T'd Transient Time Const.	0.08	
T''d Sub-Transient Time Const.	0.0120	
T'do O.C. Field Time Const.	2.5	
Ta Armature Time Const.	0.0190	
T''q Sub-Transient Time Const.	0.0192	
Resistances in Ohms (Ω) at 22°C		
Stator Winding Resistance (Ra), per phase for series connected	0.0130	
Rotor Winding Resistance (Rf)	1.55	
Exciter Stator Winding Resistance	17	
Exciter Rotor Winding Resistance per phase	0.092	
PMG Phase Resistance (Rpmg) per phase	1.9	
Positive Sequence Resistance (R1)	0.0163	
Negative Sequence Resistance (R2)	0.0187	
Zero Sequence Resistance (R0)	0.0163	
Saturation Factors		
	690V	
SG1.0	0.418	
SG1.2	1.987	
Mechanical Data		
Shaft and Keys	All alternator rotors are dynamically balanced to better than BS6861: Part 1 Grade 2.5 for minimum vibration in operation. Two bearing generators are balanced with a half key.	
	1 Bearing	2 Bearing
SAE Adaptor	SAE 00, 0, 0.5, 1	SAE 00, 0, 0.5, 1
Moment of Inertia	6.8928 kgm ²	6.6149 kgm ²
Weight Wound Stator	584kg	584kg
Weight Wound Rotor	502kg	473kg
Weight Complete Alternator	1263kg	1275kg
Shipping weight in a Crate	1355kg	1395kg
Packing Crate Size	166x87x124(cm)	166x87x124(cm)
Maximum Over Speed	2250 RPM for two minutes	
Bearing Drive End	-	BALL.6220(ISO)
Bearing Non-Drive End	BALL.6314(ISO)	BALL.6314(ISO)

STAMFORD®

S5L1S-C4 Wdg.27

THREE PHASE EFFICIENCY CURVES

60Hz

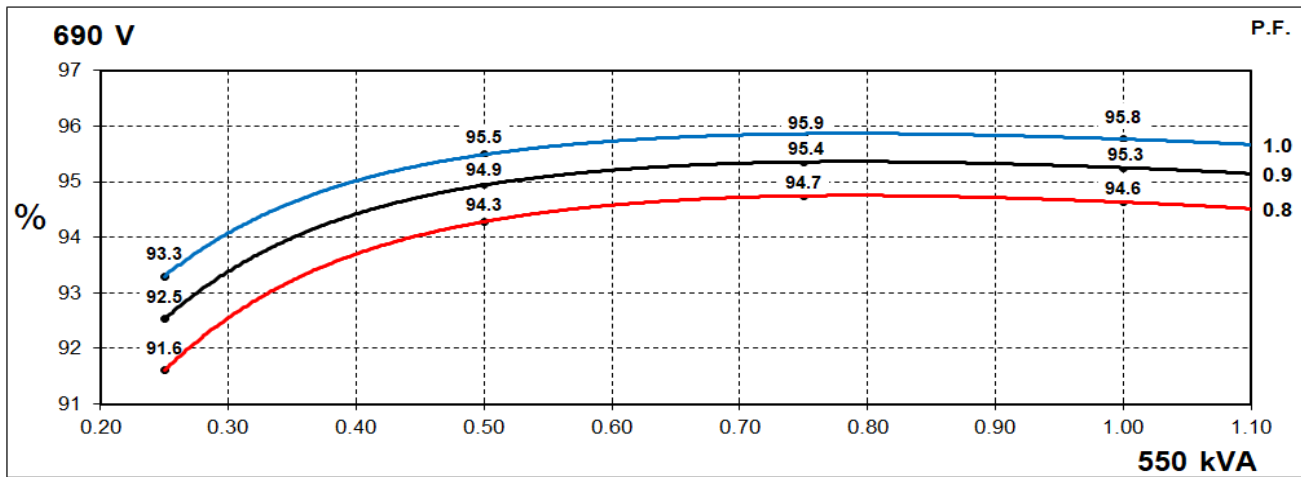
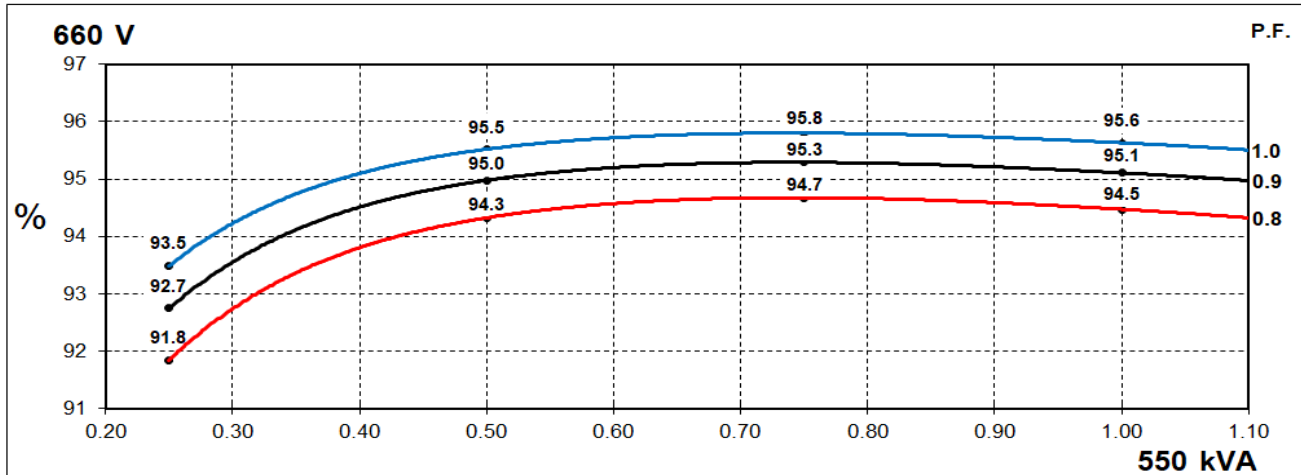

STAMFORD

S5L1S-C4 Wdg.27

Locked Rotor Motor Starting Curves - Separately Excited

60Hz

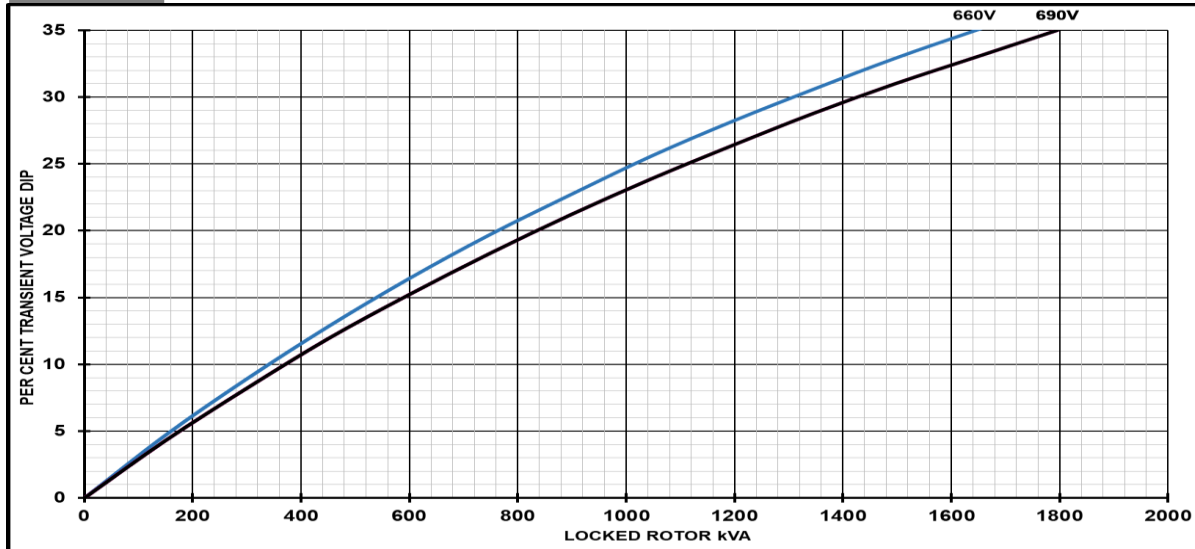

Transient Voltage Dip Scaling Factor		Transient Voltage Rise Scaling Factor
PF	Factor	For voltage rise multiply voltage dip by 1.25
< 0.5	1	
0.5	0.97	
0.6	0.93	
0.7	0.9	
0.8	0.85	
0.9	0.83	

STAMFORD

S5L1S-C4 Wdg.27

Locked Rotor Motor Starting Curves - Self Excited

60Hz

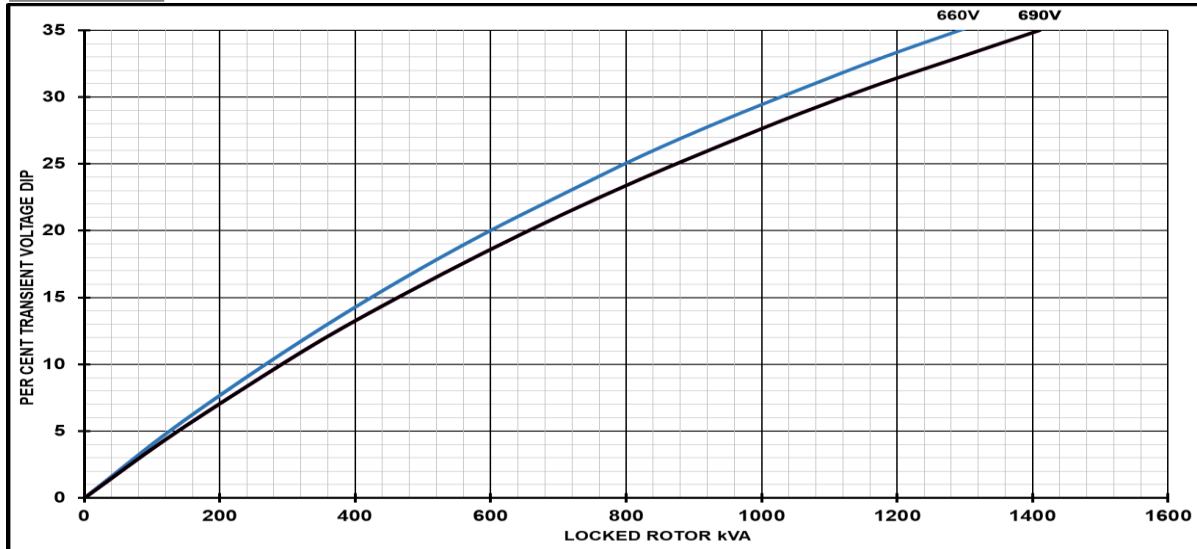

Transient Voltage Dip Scaling Factor		Transient Voltage Rise Scaling Factor
PF	Factor	For voltage rise multiply voltage dip by 1.25
< 0.5	1	
0.5	0.97	
0.6	0.93	
0.7	0.9	
0.8	0.85	
0.9	0.83	

STAMFORD[®]

S5L1S-C4 Wdg.27

Three-phase Short Circuit Decrement Curve - Separately Exited

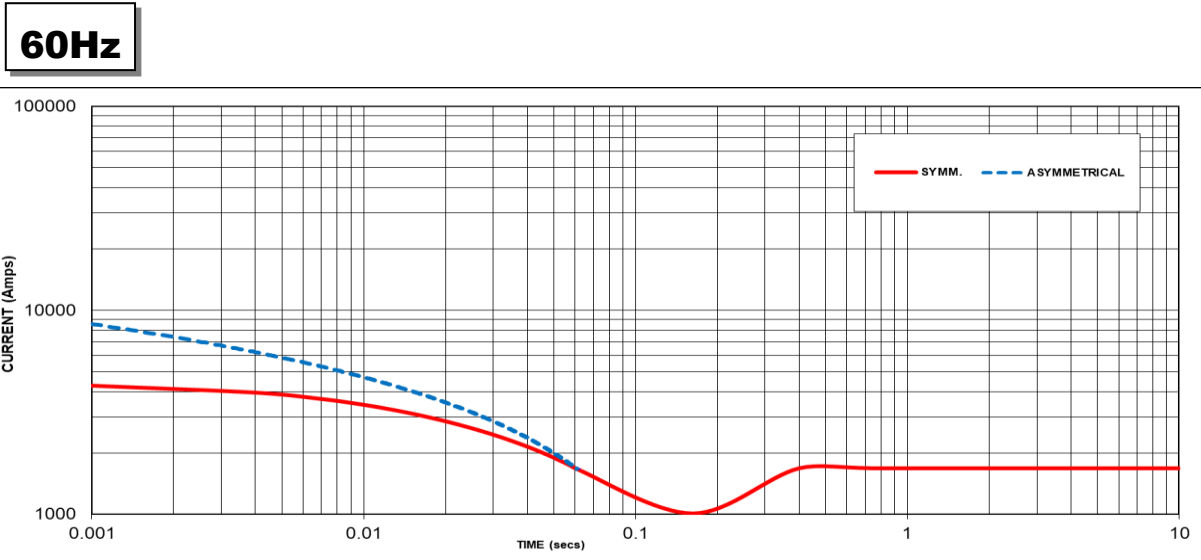

Sustained Short Circuit = 1680 Amps

Note 1

The following multiplication factors should be used to adjust the values from curve between time 0.001 seconds and the minimum current point in respect of nominal operating voltage :

50Hz		60Hz	
Voltage	Factor	Voltage	Factor
-	-	660V	X 1.00
-	-	690V	X 1.05
-	-	-	-
-	-	-	-

The sustained current value is constant irrespective of voltage level

Note 2

The following multiplication factor should be used to convert the values calculated in accordance with NOTE 1 to those applicable to the various types of short circuit :

	3-phase	2-phase L-L	1-phase L-N
Instantaneous	x 1.00	x 0.87	x 1.30
Minimum	x 1.00	x 1.80	x 3.20
Sustained	x 1.00	x 1.50	x 2.50
Max. sustained duration	10 sec.	5 sec.	2 sec.

All other times are unchanged

Note 3

Curves are drawn for Star connected machines under no-load excitation at rated speeds. For other connection (where applicable) the following multipliers should be applied to current values as shown :

Parallel Star = Curve current value X 2

Series Delta = Curve current value X 1.732

STAMFORD

S5L1S-C4 Wdg.27

Typical Alternator Operating Charts

690V/60Hz

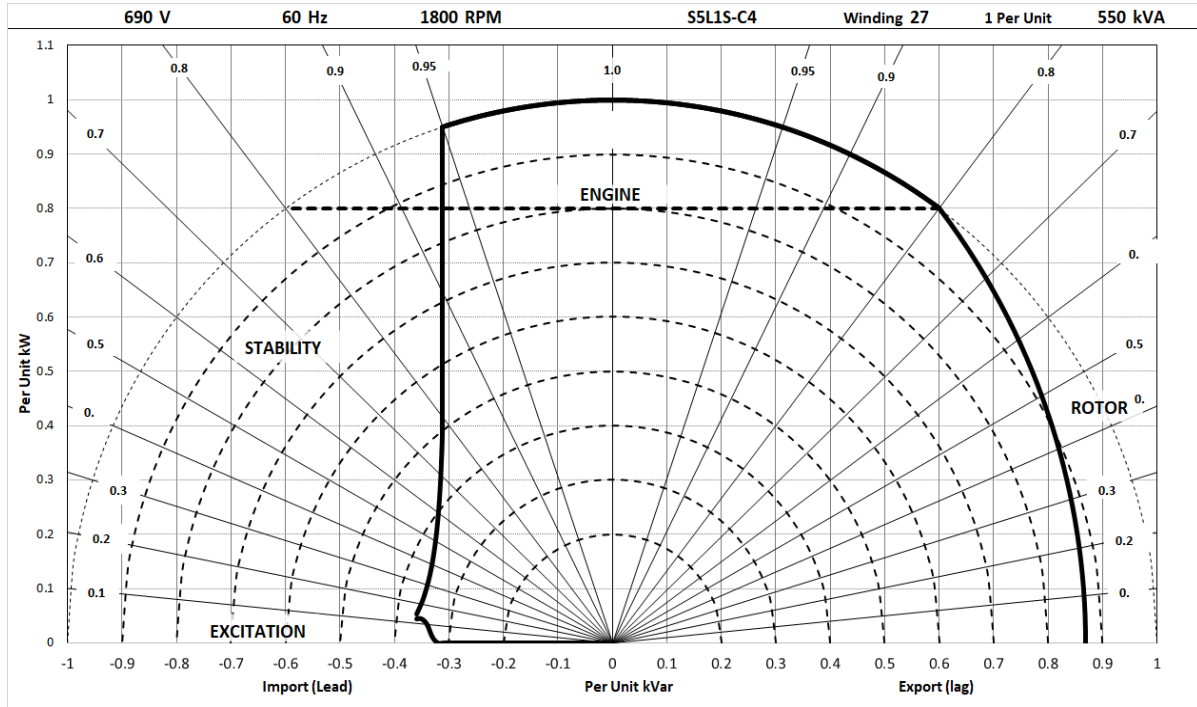

STAMFORD®

S5L1S-C4 Wdg.27

RATINGS AT 0.8 POWER FACTOR

Class - Temp Rise		Standby - 163/27°C		Standby - 150/40°C		Cont. H - 125/40°C		Cont. F - 105/40°C	
50 Hz	Series Star (V)	N/A		N/A		N/A		N/A	
	Parallel Star (V)	N/A		N/A		N/A		N/A	
	Series Delta (V)	N/A		N/A		N/A		N/A	
	kVA	N/A		N/A		N/A		N/A	
	kW	N/A		N/A		N/A		N/A	
	Efficiency (%)	N/A		N/A		N/A		N/A	
	kW Input	N/A		N/A		N/A		N/A	

60 Hz	Series Star (V)	660	690	660	690	660	690	660	690
	Parallel Star (V)	330	345	330	345	330	345	330	345
	Series Delta (V)	380	400	380	400	380	400	380	400
	kVA	600	600	580	580	550	550	500	500
	kW	480	480	464	464	440	440	400	400
	Efficiency (%)	94.3	94.5	94.4	94.6	94.5	94.6	94.6	94.7
	kW Input	509	508	492	491	466	465	423	422

De-Rates

All values tabulated above are subject to the following reductions:

- 5% when air inlet filters are fitted
- 3% for every 500 meters by which the operating altitude exceeds 1000 meters above mean sea level
- 3% for every 5°C by which the operational ambient temperature exceeds 40°C @ Class H temperature rise (please refer to applications for ambient temperature de-rates at other temperature rise classes)
- For any other operating conditions impacting the cooling circuit please refer to applications

Note: Requirement for operating in an ambient exceeding 60°C and altitude exceeding 4000 meters (for <690V) or 1500 meters (for >690V) must be referred to applications.

Dimensional and Torsional Drawing

For dimensional and torsional information please refer to the alternator General Arrangement and rotor drawings available on our website (<http://stamford-avk.com/>)

Note: Continuous development of our products means that the information contained in our data sheets can change without notice, and specifications should always be confirmed with Cummins Generator Technologies prior to purchase.



Follow us @stamfordavk



Cummins Generator Technologies



View our videos at youtube.com/stamfordavk

news.stamford-avk.com

**For Applications Support:
applications@cummins.com**

**For Customer Service:
emea.service@cummins.com**

**For General Enquiries:
Stamford-avk@cummins.com**

Copyright 2016. Cummins Generator Technologies Ltd. All rights reserved.
Cummins and the Cummins logo are registered trade marks of Cummins Inc.
STAMFORD is a registered trade mark of Cummins Generator Technologies Ltd.

