

STAMFORD®

S7L1M-F4 & S7L1W-F4 (Marine) Wdg.312 - Technical Data Sheet

Standards

STAMFORD industrial alternators meet the requirements of the relevant parts of the IEC 60034 and the relevant sections of other international standards such as BS5000-3, ISO 8528-3, VDE 0530, NEMA MG1-32, CSA C22.2-100 and AS 60034. Other standards and certifications can be considered on request.

Quality Assurance

Alternators are manufactured using production procedures having a quality assurance level to BS EN ISO 9001.

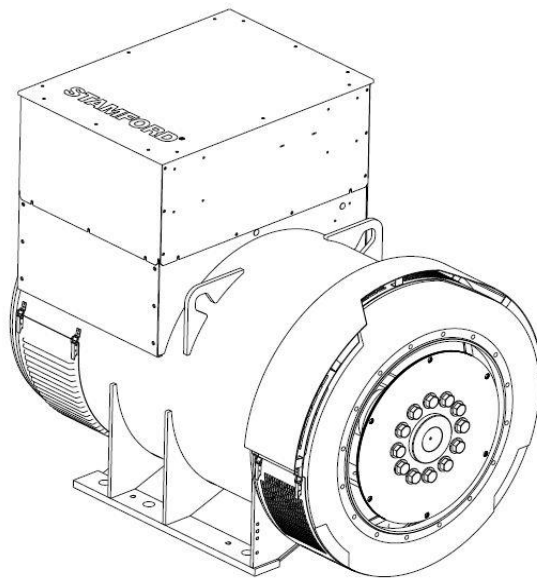

*Image depicts the S7L1M alternator

Excitation and Voltage Regulators

Excitation System					
AVR Type	MX322	DECS100	DECS150		
Voltage Regulation	± 0.5%	± 0.25%	± 0.25%		with 4% Engine Governing
AVR Power	PMG	PMG	PMG		

No Load Excitation Voltage (V)	15.4 - 14.7
No Load Excitation Current (A)	0.68 - 0.64
Full Load Excitation Voltage (V)	64
Full Load Excitation Current (A)	2.8
Exciter Time Constant (seconds)	0.125

STAMFORD

S7L1M-F4 & S7L1W-F4 (Marine) Wdg.312

Electrical Data								
Insulation System	H							
Stator Winding	Double Layer Concentric							
Winding Pitch	2/3							
Winding Leads	6							
Winding Number	312							
Number of Poles	4							
IP Rating	IP23 or IP44* (see footnote)							
RFI Suppression	BS EN 61000-6-2 & BS EN 61000-6-4, VDE 0875G, VDE 0875N. Refer to factory for others							
Waveform Distortion	NO LOAD < 1.5% NON-DISTORTING BALANCED LINEAR LOAD < 5.0%							
Short Circuit Ratio	1/Xd							
Steady State X/R Ratio	22.84							
50 Hz					60 Hz			
Telephone Interference	THF<2%				TIF<50			
Cooling Air Flow	2.52 m³/sec				3.02 m³/sec			
Voltage Star (V)	380	400	415	440	416	440	460	480
Voltage Parallel Star (V)	-	-	-	-	-	-	-	-
Voltage Delta (V)	-	-	-	-	-	-	-	-
kVA Base Rating (Class H) for Reactance Values (kVA)	1625	1675	1675	1650	1781	1950	1987	2025
Saturated Values in Per Unit at Base Ratings and Voltages								
Xd Dir. Axis Synchronous	2.43	2.26	2.10	1.84	2.66	2.61	2.43	2.27
X'd Dir. Axis Transient	0.18	0.17	0.16	0.14	0.20	0.19	0.18	0.17
X" d Dir. Axis Subtransient	0.13	0.12	0.11	0.10	0.14	0.14	0.13	0.12
Xq Quad. Axis Reactance	1.78	1.66	1.54	1.35	1.95	1.91	1.78	1.67
X" q Quad. Axis Subtransient	0.21	0.19	0.18	0.16	0.23	0.22	0.21	0.19
XL Stator Leakage Reactance	0.08	0.07	0.07	0.06	0.08	0.08	0.08	0.07
X2 Negative Sequence Reactance	0.15	0.14	0.13	0.12	0.17	0.16	0.15	0.14
X0 Zero Sequence Reactance	0.03	0.03	0.02	0.02	0.03	0.03	0.03	0.03
Unsaturated Values in Per Unit at Base Ratings and Voltages								
Xd Dir. Axis Synchronous	2.91	2.71	2.52	2.20	3.19	3.13	2.92	2.73
X'd Dir. Axis Transient	0.21	0.19	0.18	0.16	0.23	0.22	0.21	0.19
X" d Dir. Axis Subtransient	0.15	0.14	0.13	0.11	0.16	0.16	0.15	0.14
Xq Quad. Axis Reactance	1.83	1.71	1.58	1.39	2.01	1.97	1.84	1.72
X" q Quad. Axis Subtransient	0.25	0.23	0.22	0.19	0.27	0.27	0.25	0.23
XL Stator Leakage Reactance	0.09	0.08	0.07	0.07	0.09	0.09	0.09	0.08
Xlr Rotor Leakage Reactance	0.19	0.18	0.16	0.14	0.21	0.20	0.19	0.18
X2 Negative Sequence Reactance	0.18	0.17	0.16	0.14	0.20	0.20	0.18	0.17
X0 Zero Sequence Reactance	0.03	0.03	0.03	0.03	0.04	0.04	0.03	0.03

*Notes:

- 1) S7L1W: IP44 rating with IC81W cooling (watercooled) and 38°C maximum water inlet temperature.
- 2) S7L1M: IP23 rating with IC01 cooling (open-circuit cooling) as standard.

STAMFORD

S7L1M-F4 & S7L1W-F4 (Marine) Wdg.312

Time Constants (Seconds)		
T'd Transient Time Const.	0.150	
T''d Sub-Transient Time Const.	0.017	
T'do O.C. Field Time Const.	4.290	
Ta Armature Time Const.	0.028	
T''q Sub-Transient Time Const.	0.0102	
Resistances in Ohms (Ω) at 22°C		
Stator Winding Resistance (Ra), per phase for series connected	0.00085	
Rotor Winding Resistance (Rf)	1.95	
Exciter Stator Winding Resistance	22.3	
Exciter Rotor Winding Resistance per phase	0.065	
PMG Phase Resistance (Rpmg) per phase	1.91	
Positive Sequence Resistance (R1)	0.0011	
Negative Sequence Resistance (R2)	0.0012	
Zero Sequence Resistance (R0)	0.0011	
Saturation Factors	400V	480V
SG1.0	0.281	0.304
SG1.2	1.308	1.184
Mechanical Data		
Shaft and Keys	All alternator rotors are dynamically balanced to better than ISO 21940-11 Grade 2.5 for minimum vibration in operation. Two bearing generators are balanced with a half key.	
	1 Bearing	2 Bearing
SAE Adaptor	SAE0 , 00	SAE0 , 00
Moment of Inertia	40.98 kgm ²	40.08 kgm ²
Weight Wound Stator	1518kg	1518kg
Weight Wound Rotor	1353kg	1300kg
Weight Complete Alternator	3350kg	3264kg
Shipping weight in a Crate	3399kg	3399kg
Packing Crate Size	200 X 105 X 155(cm)	200 X 105 X 155(cm)
Maximum Over Speed	2250 RPM for two minutes	
Bearing Drive End	-	BALL. 6228; Sleeve EFWLK 14 (optional)
Bearing Non-Drive End	BALL. 6319	BALL. 6319; Sleeve EFNLQ 11 (optional)

Notes:

- 1) Mechanical data are applicable for S7L1M with anti-friction bearing. Refer the GA and rotor drawings for S7L1W and sleeve bearing.
- 2) S7L1W and/ or sleeve bearings are available for 2-bearing alternators only.
- 3) SAE adaptor options are not applicable for sleeve bearing.

STAMFORD®

S7L1M-F4 & S7L1W-F4 (Marine) Wdg.312

THREE PHASE EFFICIENCY CURVES

50Hz

60Hz

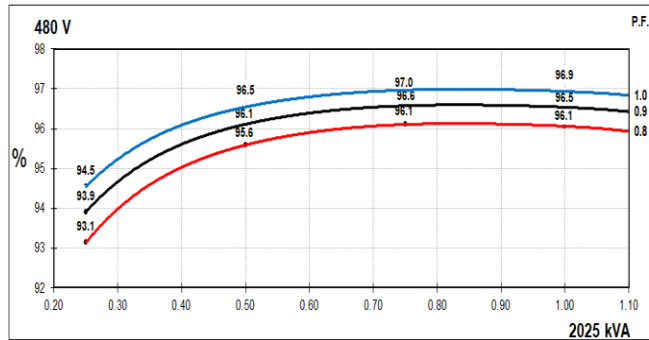
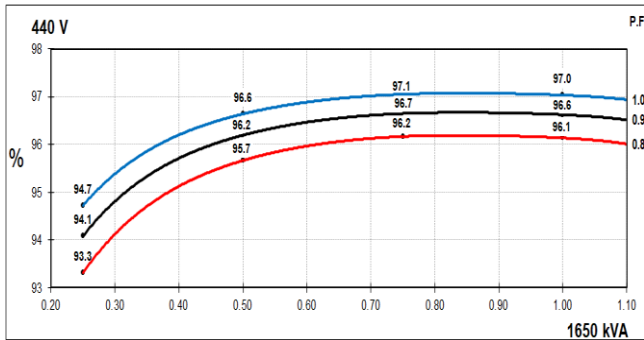
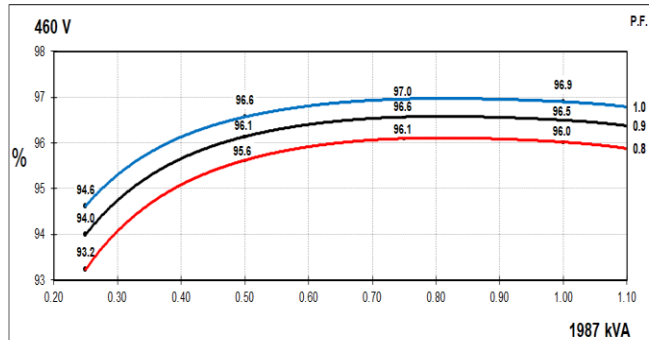
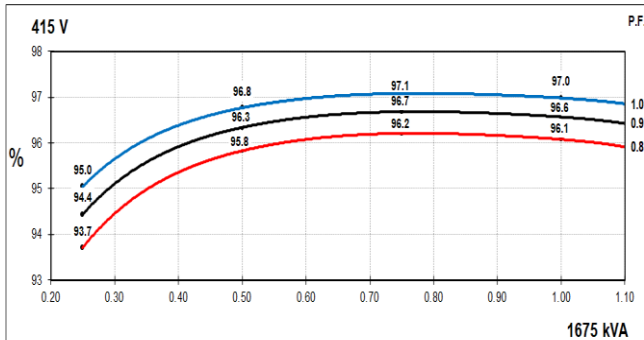
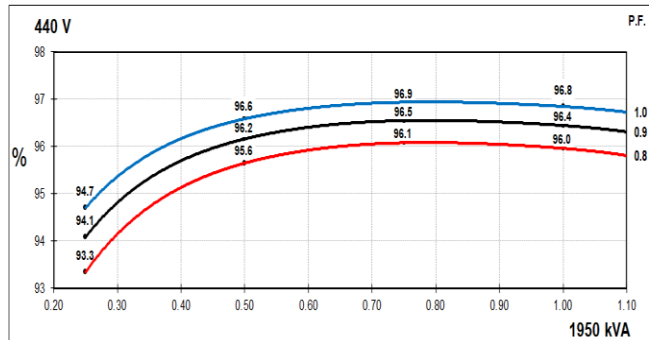
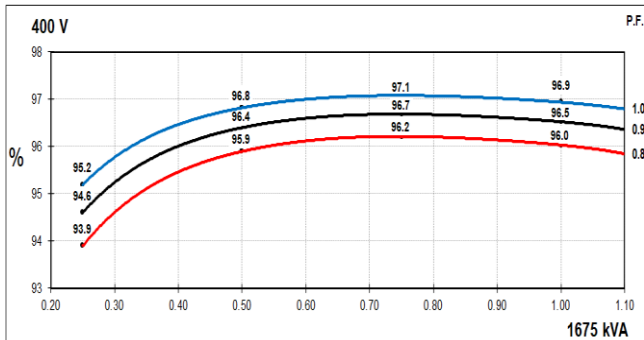
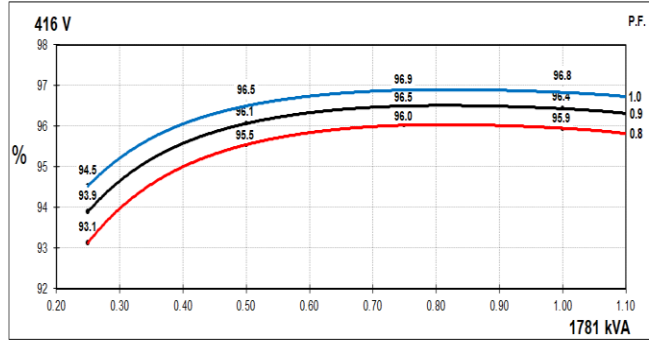
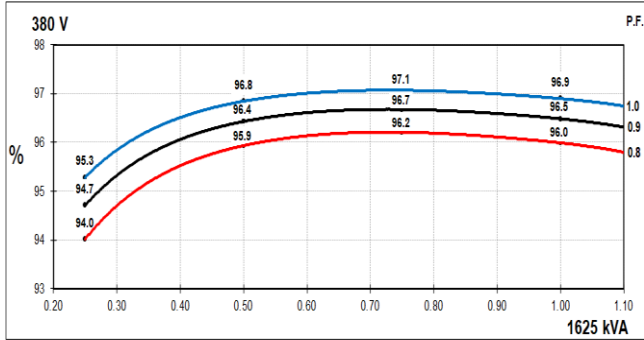

STAMFORD®

S7L1M-F4 & S7L1W-F4 (Marine) Wdg.312

Locked Rotor Motor Starting Curves - Separately Excited

50Hz

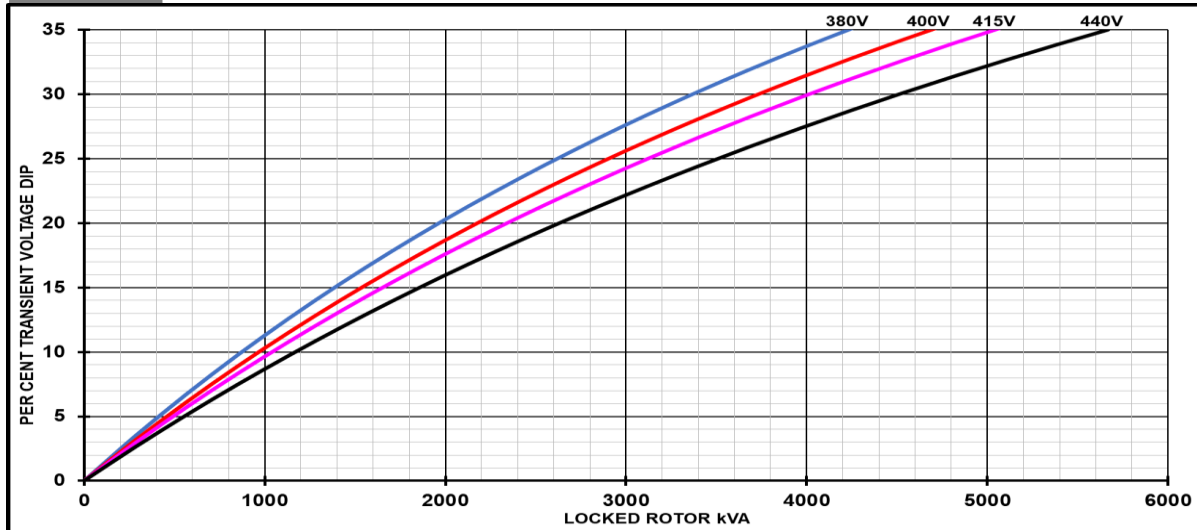

60Hz

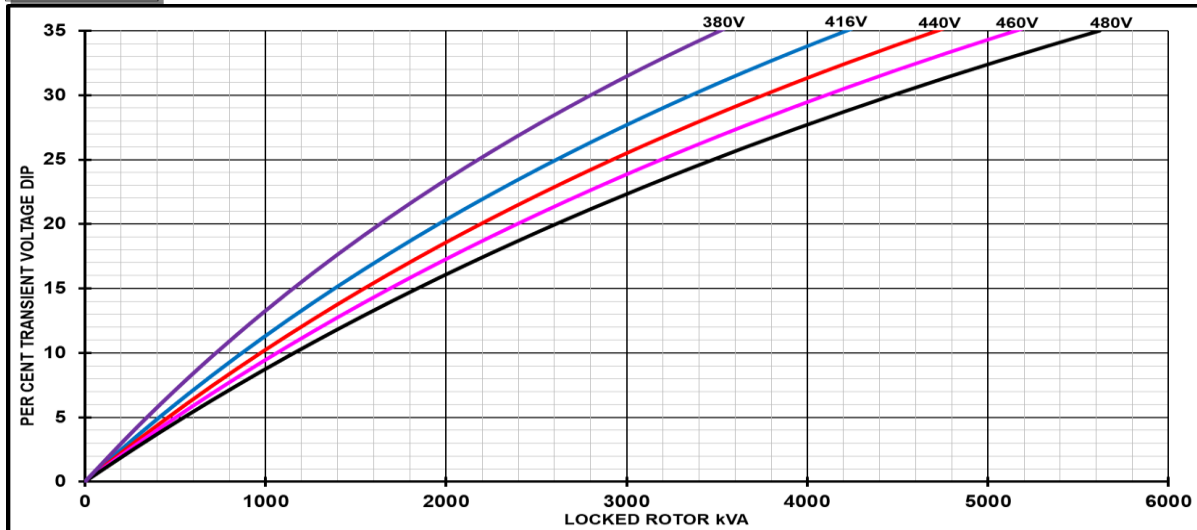

Transient Voltage Dip Scaling Factor		Transient Voltage Rise Scaling Factor	
Lagging PF	Scaling Factor	Lagging PF	Scaling Factor
<= 0.4	1.00	<= 0.4	1.25
0.5	0.95	0.5	1.20
0.6	0.90	0.6	1.15
0.7	0.86	0.7	1.10
0.8	0.83	> 0.7	1.00
0.9	0.75		
0.95	0.70		
1	0.65		

Note: To determine % Transient Voltage Dip or Voltage Rise at various PF, multiply the % Voltage Dip from the curve directly by the Scaling Factor.

STAMFORD®

S7L1M-F4 & S7L1W-F4 (Marine) Wdg.312

Three-phase Short Circuit Decrement Curve - Separately Excited

50Hz

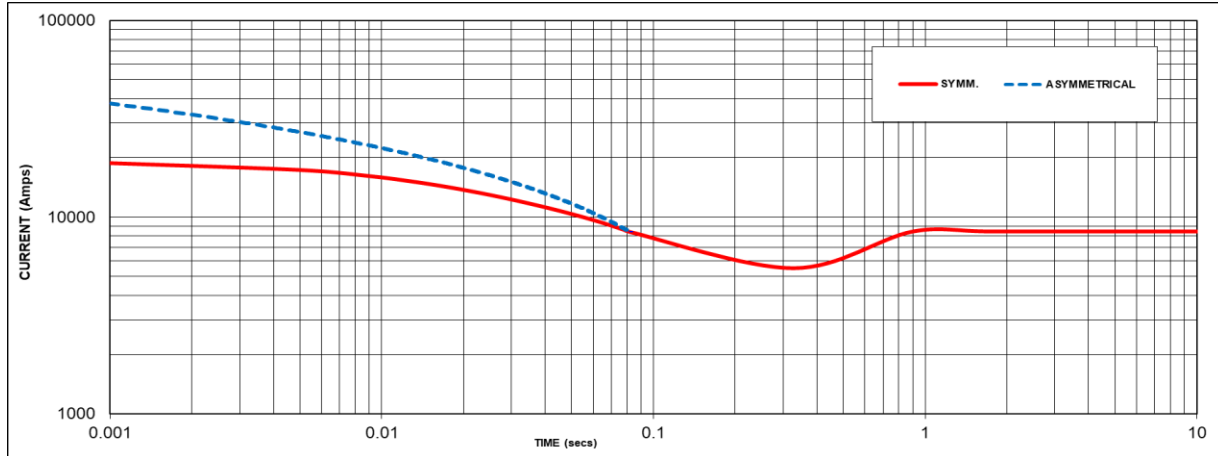

Sustained Short Circuit = 8455 Amps

60Hz

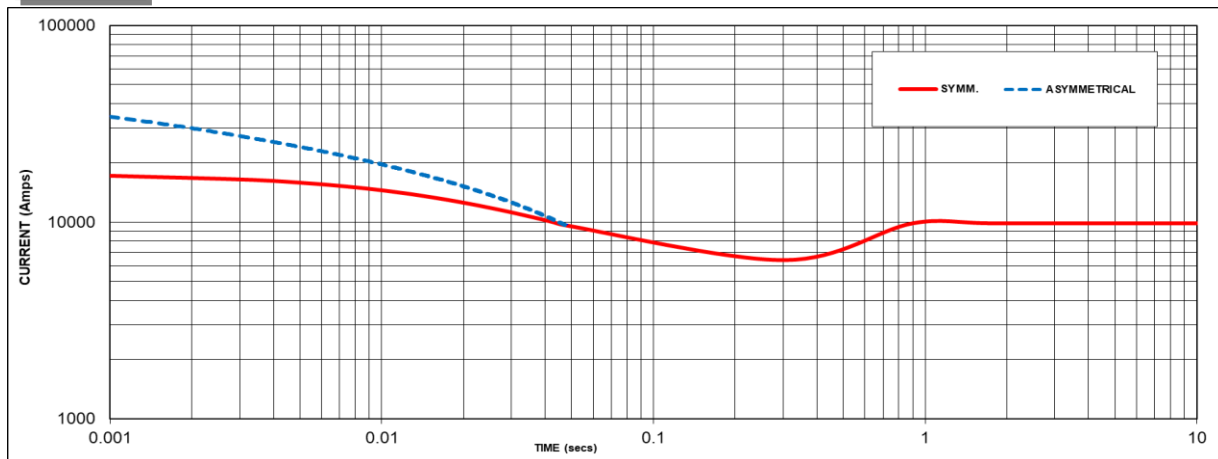

Sustained Short Circuit = 9895 Amps

Note 1

The following multiplication factors should be used to adjust the values from curve between time 0.001 seconds and the minimum current point in respect of nominal operating voltage :

50Hz		60Hz	
Voltage	Factor	Voltage	Factor
380V	X 1.00	416V	X 1.00
400V	X 1.05	440V	X 1.06
415V	X 1.09	460V	X 1.10
440V	X 1.16	480V	X 1.15

The sustained current value is constant irrespective of voltage level

Note 2

The following multiplication factor should be used to convert the values calculated in accordance with NOTE 1 to those applicable to the various types of short circuit :

	3-phase	2-phase L-L	1-phase L-N
Instantaneous	x 1.00	x 0.87	x 1.30
Minimum	x 1.00	x 1.80	x 3.20
Sustained	x 1.00	x 1.50	x 2.50
Max. sustained duration	10 sec.	5 sec.	2 sec.

Note 3

All other times are unchanged

Curves are drawn for Star connections under no-load excitation at rated speeds. For other connection (where applicable) the following multipliers should be applied to current values as shown :

Parallel Star = Curve current value X 2

Series Delta = Curve current value X 1.732

STAMFORD

S7L1M-F4 & S7L1W-F4 (Marine) Wdg.312

Typical Alternator Operating Charts

400V/50Hz

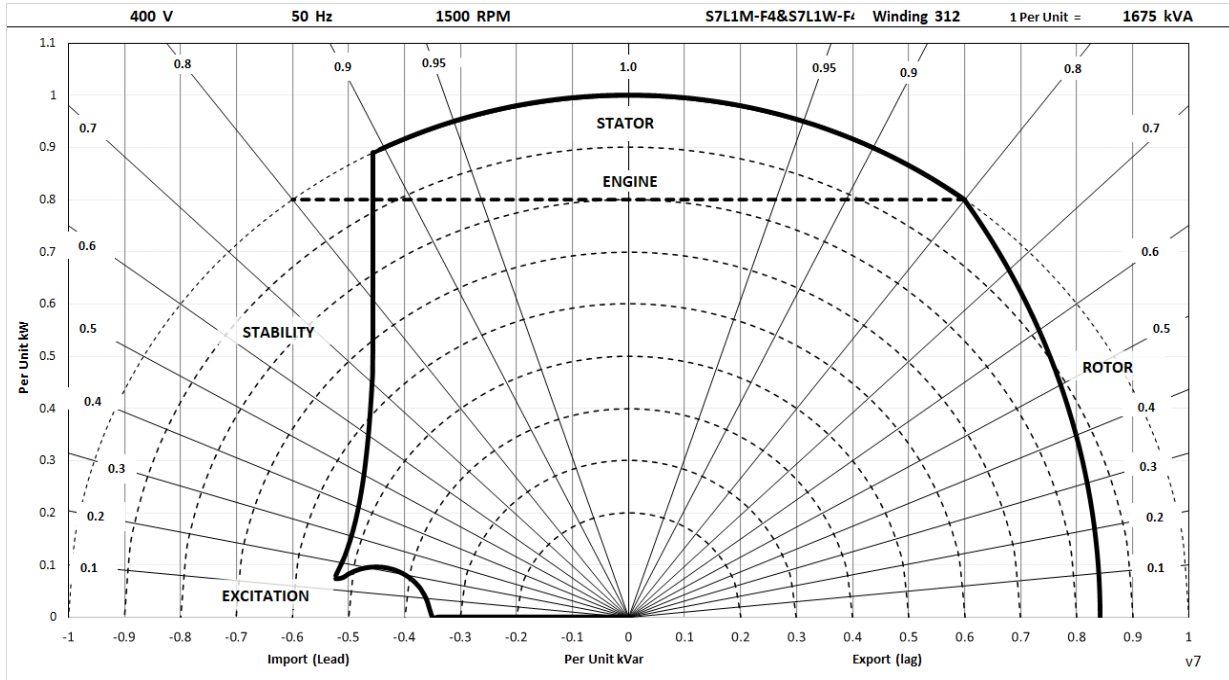

480V/60Hz

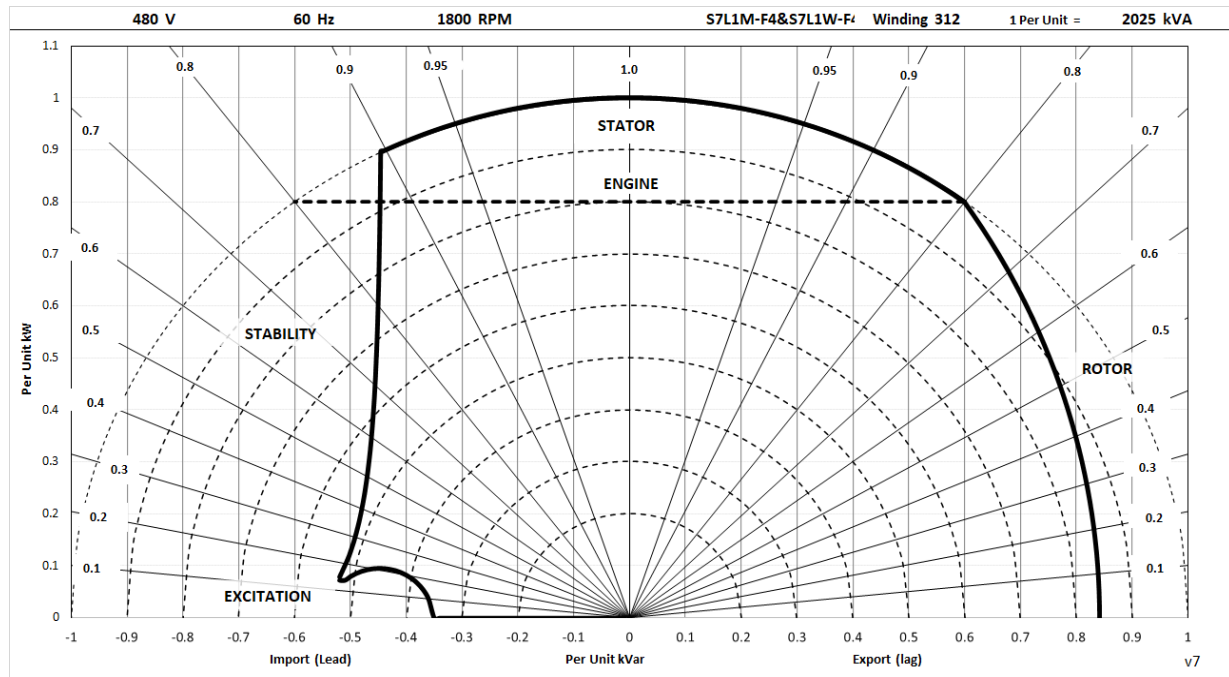

STAMFORD®

S7L1M-F4 & S7L1W-F4 (Marine) Wdg.312

RATINGS AT 0.8 POWER FACTOR

Class - Temp Rise		Standby				Cont. H - 110/50°C				Cont. F - 90/50°C				Cont. B - 70/50°C			
50 Hz	Star (V)	380	400	415	440	380	400	415	440	380	400	415	440	380	400	415	440
	Parallel Star (V)	N/A	N/A	N/A	N/A	N/A	N/A	N/A	N/A	N/A	N/A	N/A	N/A	N/A	N/A	N/A	N/A
	Delta (V)	N/A	N/A	N/A	N/A	N/A	N/A	N/A	N/A	N/A	N/A	N/A	N/A	N/A	N/A	N/A	N/A
	kVA	N/A	N/A	N/A	N/A	1625	1675	1675	1650	1365	1435	1490	1520	1325	1370	1370	1340
	kW	N/A	N/A	N/A	N/A	1300	1340	1340	1320	1092	1148	1192	1216	1060	1096	1096	1072
	Efficiency (%)	N/A	N/A	N/A	N/A	96.0	96.0	96.1	96.1	96.2	96.2	96.2	96.2	96.2	96.2	96.2	96.2
	kW Input	N/A	N/A	N/A	N/A	1354	1395	1395	1373	1135	1194	1239	1264	1102	1139	1139	1114

60 Hz	Star (V)	416	440	460	480	416	440	460	480	416	440	460	480	416	440	460	480
	Parallel Star (V)	N/A	N/A	N/A	N/A	N/A	N/A	N/A	N/A	N/A	N/A	N/A	N/A	N/A	N/A	N/A	N/A
	Delta (V)	N/A	N/A	N/A	N/A	N/A	N/A	N/A	N/A	N/A	N/A	N/A	N/A	N/A	N/A	N/A	N/A
	kVA	N/A	N/A	N/A	N/A	1781	1950	1987	2025	1694	1800	1844	1875	1494	1594	1625	1656
	kW	N/A	N/A	N/A	N/A	1425	1560	1590	1620	1355	1440	1475	1500	1195	1275	1300	1325
	Efficiency (%)	N/A	N/A	N/A	N/A	95.9	96.0	96.0	96.1	96.0	96.0	96.1	96.1	96.0	96.1	96.1	96.1
	kW Input	N/A	N/A	N/A	N/A	1485	1626	1656	1686	1412	1499	1535	1561	1245	1327	1353	1378

Note:

For S7L1W marine application, ratings are applicable for water inlet temperature up to maximum 38°C.

De-rates

All values tabulated above are subject to the following reductions:

- 5% when air inlet filters are fitted
- 3% for every 500 meters by which the operating altitude exceeds 1000 meters above mean sea level
- 3% for every 5°C by which the operational ambient temperature exceeds 40°C @ Class H temperature rise (not applicable to S7L1W)
- For marine alternators (IP23), 3% for every 5°C by which the operational ambient temperature exceeds 50°C
- For any other operating conditions impacting the cooling circuit please refer to applications

Note: Requirement for operating in an ambient exceeding 60°C and altitude exceeding 4000 meters (for <690V) or 1500 meters (for >690V) must be referred to applications.

Dimensional and Torsional Drawing

For dimensional and torsional information please refer to the alternator General Arrangement and rotor drawings available on our website (<http://stamford-avk.com/>)

Note: Continuous development of our products means that the information contained in our data sheets can change without notice, and specifications should always be confirmed with Cummins Generator Technologies prior to purchase.



Follow us @stamfordavk



Cummins Generator Technologies



View our videos at youtube.com/stamfordavk

stamford-avk.com

**For Applications Support:
applications@cummins.com**

**For Customer Service:
emea.service@cummins.com**

**For General Enquiries:
Stamford-avk@cummins.com**

Copyright 2021. Cummins Generator Technologies Ltd. All rights reserved.
Cummins and the Cummins logo are registered trade marks of Cummins Inc.
STAMFORD is a registered trade mark of Cummins Generator Technologies Ltd.

