

# STAMFORD®

**UCM224G** - Winding 06

Technical Data Sheet

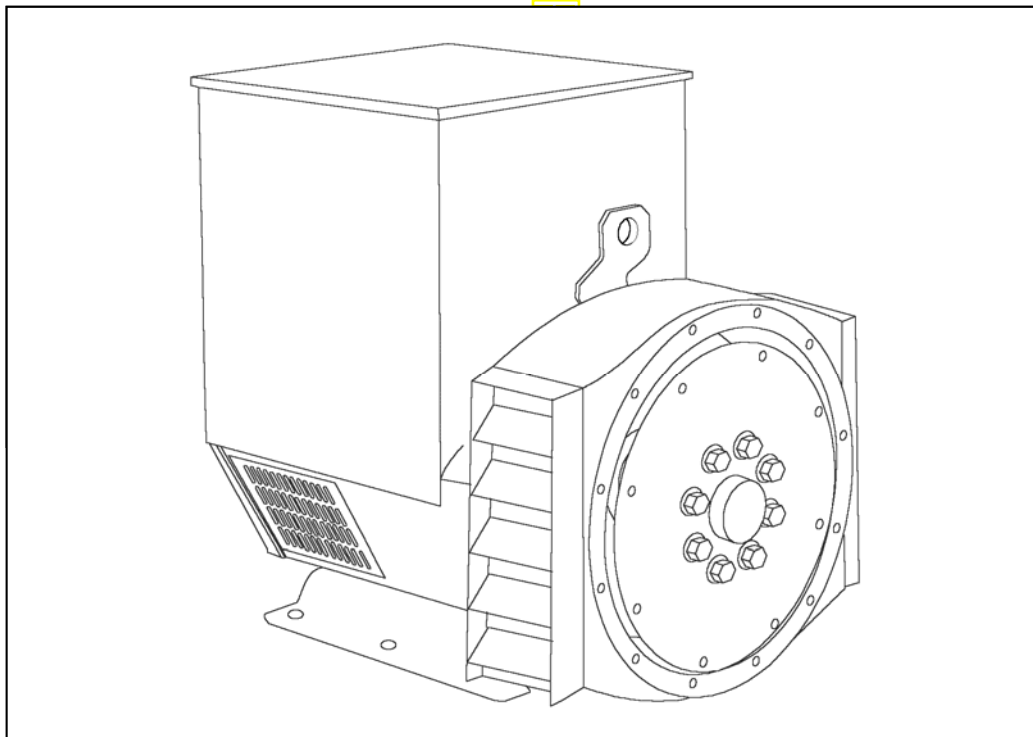

# UCM224G

## SPECIFICATIONS & OPTIONS

**STAMFORD**

### STANDARDS

Marine generators may be certified to Lloyds, DnV, Bureau Veritas, ABS, Germanischer-Lloyd or RINA. Other standards and certifications can be considered on request.

### VOLTAGE REGULATORS

#### MX341 AVR - STANDARD

This sophisticated Automatic Voltage Regulator (AVR) is incorporated into the Stamford Permanent Magnet Generator (PMG) control system, and is standard on marine generators of this type.

The PMG provides power via the AVR to the main exciter, giving a source of constant excitation power independent of generator output. The main exciter output is then fed to the main rotor, through a full wave bridge, protected by a surge suppressor. The AVR has in-built protection against sustained over-excitation, caused by internal or external faults. This de-excites the machine after a minimum of 5 seconds.

An engine relief load acceptance feature can enable full load to be applied to the generator in a single step.

#### MX321 AVR

The most sophisticated of all our AVRs combines all the features of the MX341 with, additionally, over voltage protection is built-in and short circuit current level adjustments as an optional facility.

### WINDINGS & ELECTRICAL PERFORMANCE

All generator stators are wound to 2/3 pitch. This eliminates triplen (3rd, 9th, 15th ...) harmonics on the voltage waveform and is found to be the optimum design for trouble-free supply of non-linear loads. The 2/3 pitch design avoids excessive neutral currents sometimes seen with higher winding pitches, when in parallel with the mains. A fully connected damper winding reduces oscillations during paralleling. This winding, with the 2/3 pitch and carefully selected pole and tooth designs, ensures very low waveform distortion.

### TERMINALS & TERMINAL BOX

Dedicated Single Phase windings have 4 ends brought out to the terminals, which are mounted on a cover at the non-drive end of the generator. A sheet steel terminal box contains the AVR and provides ample space for the customers' wiring and gland arrangements. It has removable panels for easy access.

### SHAFT & KEYS

All generator rotors are dynamically balanced to better than BS6861:Part 1 Grade 2.5 for minimum vibration in operation. Two bearing generators are balanced with a half key.

### INSULATION / IMPREGNATION

The insulation system is class 'H'.

All wound components are impregnated with materials and processes designed specifically to provide the high build required for static windings and the high mechanical strength required for rotating components.

### QUALITY ASSURANCE

Generators are manufactured using production procedures having a quality assurance level to BS EN ISO 9001.

The stated voltage regulation may not be maintained in the presence of certain radio transmitted signals. Any change in performance will fall within the limits of Criteria 'B' of EN 61000-6-2:2001. At no time will the steady-state voltage regulation exceed 2%.

### DE RATES

All values tabulated on page 6 are subject to the following reductions

5% when air inlet filters are fitted.

3% for every 500 metres by which the operating altitude exceeds 1000 metres above mean sea level.

3% for every 5 C by which the operational ambient temperature exceeds 50 C.

Note: Requirement for operating in an ambient exceeding 60 C must be referred to the factory.

*NB Continuous development of our products entitles us to change specification details without notice, therefore they must not be regarded as binding.*

*Front cover drawing typical of product range.*

APPROVED DOCUMENT

# UCM224G



## WINDING 06

CONTROL SYSTEM	SEPARATELY EXCITED BY P.M.G.		
A.V.R.	MX341	MX321	
VOLTAGE REGULATION	± 1%	± 0.5 %	With 4% ENGINE GOVERNING
SUSTAINED SHORT CIRCUIT	REFER TO SHORT CIRCUIT DECREMENT CURVES (page 5)		
INSULATION SYSTEM	CLASS H		
PROTECTION	IP23		
RATED POWER FACTOR	0.8		
STATOR WINDING	SINGLE LAYER CONCENTRIC		
WINDING PITCH	TWO THIRDS		
WINDING LEADS	4		
MAIN STATOR RESISTANCE	0.019 Ohms AT 22°C SERIES CONNECTED		
MAIN ROTOR RESISTANCE	0.94 Ohms at 22°C		
EXCITER STATOR RESISTANCE	20 Ohms at 22°C		
EXCITER ROTOR RESISTANCE	0.078 Ohms PER PHASE AT 22°C		
R.F.I. SUPPRESSION	BS EN 61000-6-2 & BS EN 61000-6-4, VDE 0875G, VDE 0875N. refer to factory for others		
WAVEFORM DISTORTION	NO LOAD < 1.5% NON-DISTORTING LINEAR LOAD < 5.0%		
MAXIMUM OVERSPEED	2250 Rev/Min		
BEARING DRIVE END	BALL. 6312-2RS (ISO)		
BEARING NON-DRIVE END	BALL. 6309-2RS (ISO)		
	1 BEARING	2 BEARING	
WEIGHT COMP. GENERATOR	383 kg	400 kg	
WEIGHT WOUND STATOR	139 kg	139 kg	
WEIGHT WOUND ROTOR	126.75 kg	118.38 kg	
WR <sup>2</sup> INERTIA	0.7136 kgm <sup>2</sup>	0.6818 kgm <sup>2</sup>	
SHIPPING WEIGHTS in a crate	404 kg	420 kg	
PACKING CRATE SIZE	105 x 57 x 96(cm)	105 x 57 x 96(cm)	
TELEPHONE INTERFERENCE	THF<2%	TIF<50	
COOLING AIR	0.281 m <sup>3</sup> /sec 595 cfm		
VOLTAGE SERIES	220	230	240
VOLTAGE PARALLEL	110	115	120
kVA BASE RATING FOR REACTANCE VALUES	63	63	63
X <sub>d</sub> DIR. AXIS SYNCHRONOUS	2.93	2.67	2.46
X' <sub>d</sub> DIR. AXIS TRANSIENT	0.22	0.20	0.18
X'' <sub>d</sub> DIR. AXIS SUBTRANSIENT	0.15	0.14	0.13
X <sub>q</sub> QUAD. AXIS REACTANCE	1.34	1.22	1.13
X'' <sub>q</sub> QUAD. AXIS SUBTRANSIENT	0.17	0.15	0.14
X <sub>L</sub> LEAKAGE REACTANCE	0.08	0.07	0.07
X <sub>2</sub> NEGATIVE SEQUENCE	0.17	0.15	0.14
X <sub>0</sub> ZERO SEQUENCE	0.12	0.11	0.10
REACTANCES ARE SATURATED		VALUES ARE PER UNIT AT RATING AND VOLTAGE INDICATED	
T' <sub>d</sub> TRANSIENT TIME CONST.	0.03s		
T'' <sub>d</sub> SUB-TRANSTIME CONST.	0.008s		
T' <sub>do</sub> O.C. FIELD TIME CONST.	0.75s		
T <sub>a</sub> ARMATURE TIME CONST.	0.007s		
SHORT CIRCUIT RATIO	1/X <sub>d</sub>		

UCM224G  
Winding 06

**STAMFORD**

**SINGLE PHASE EFFICIENCY CURVES**

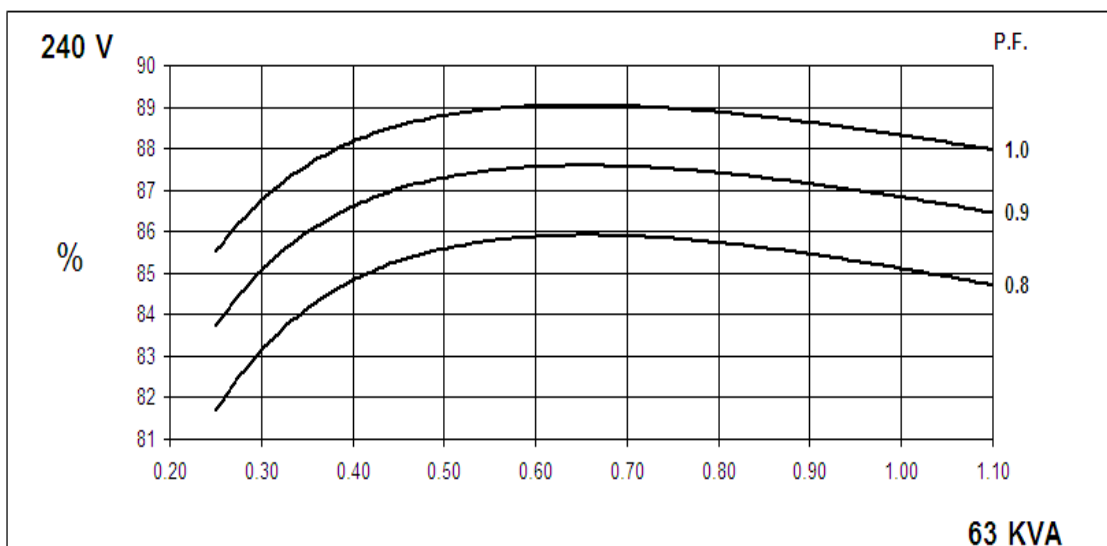
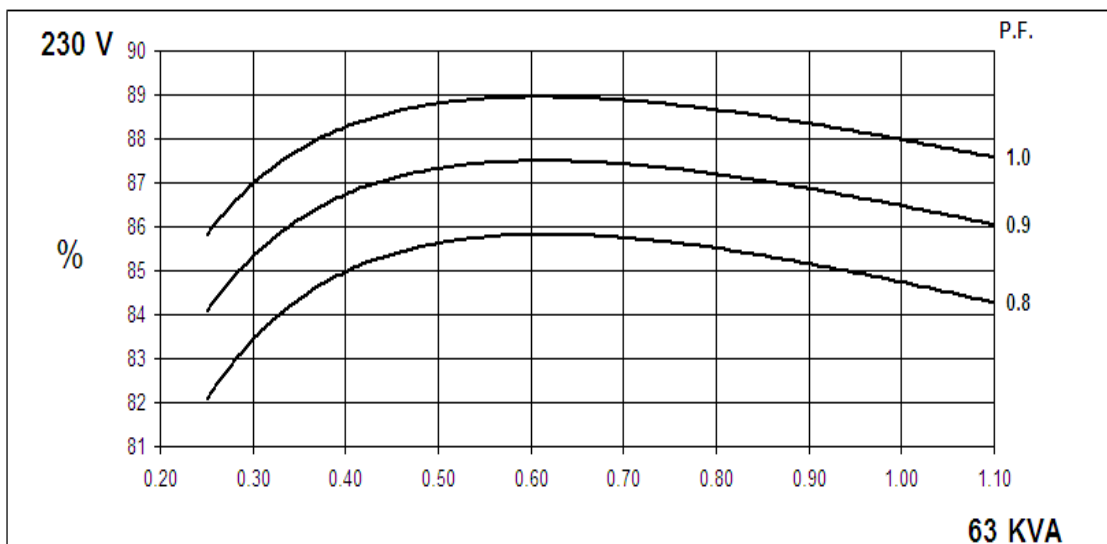
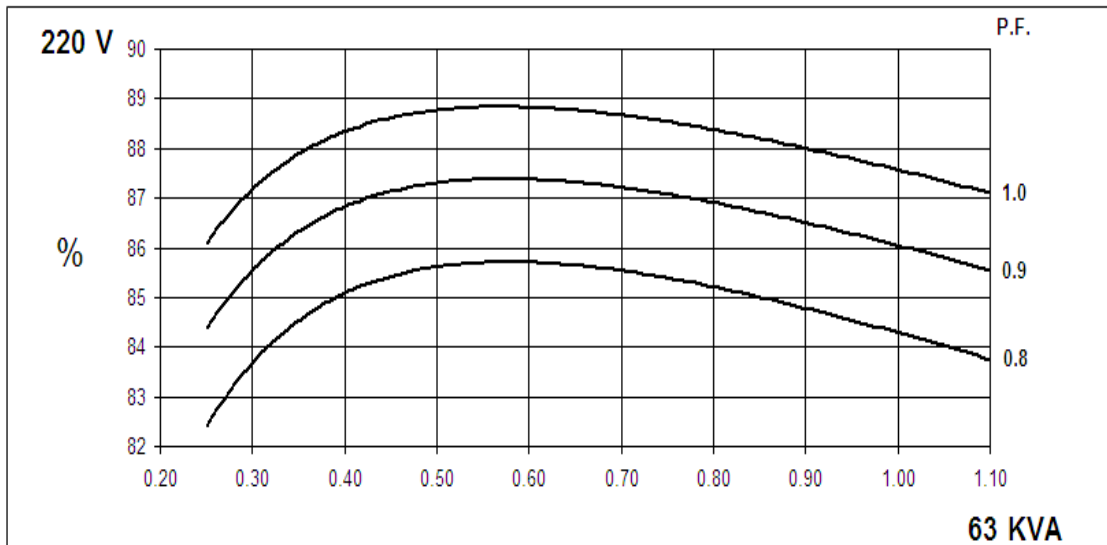

**UCM224G  
Winding 06  
Locked Rotor Motor Starting Curve**

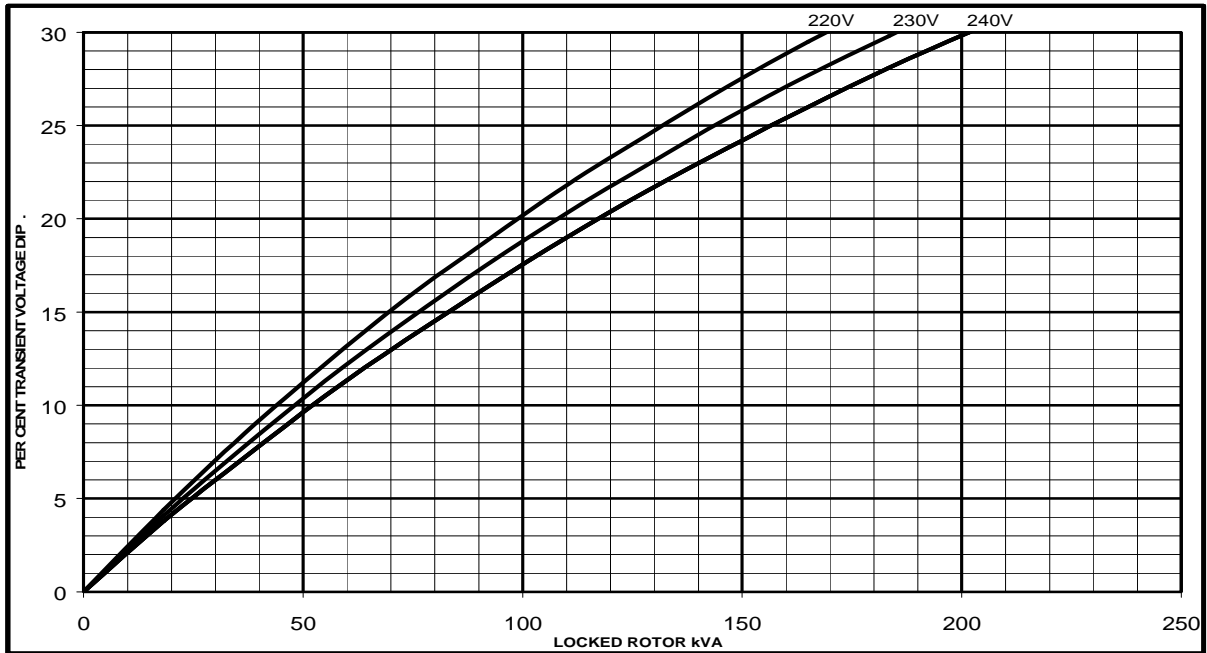

**Short Circuit Decrement Curve. No-load Excitation at Rated Speed  
Based on series connection.**

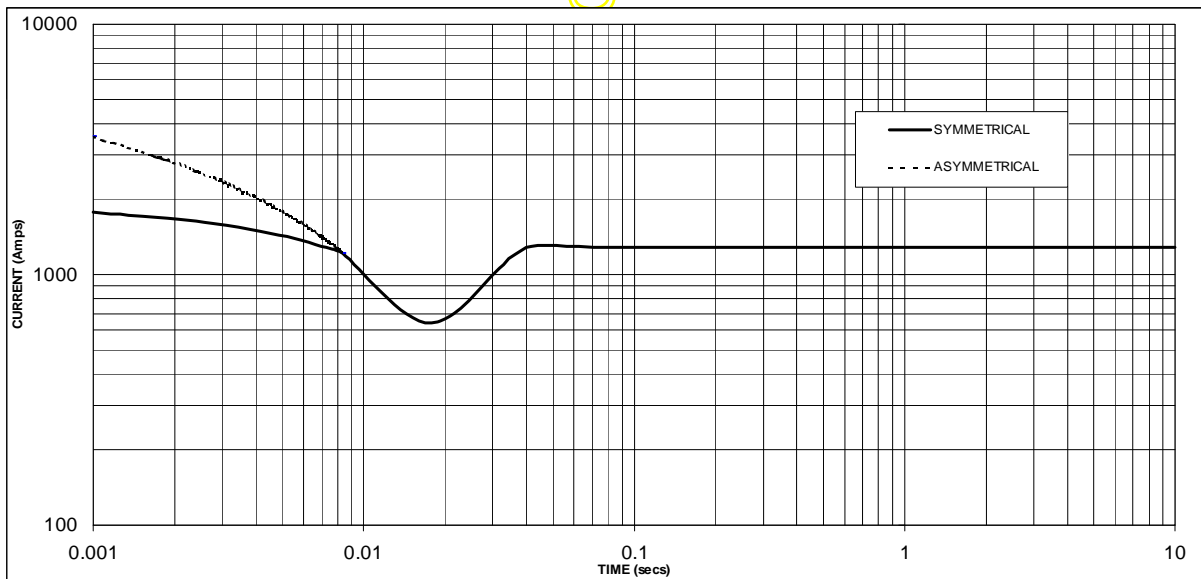

Sustained Short Circuit = 1280 Amps

**Note**

The following multiplication factors should be used to adjust the values from curve between time 0.001 seconds and the minimum current point in respect of nominal operating voltage :

Voltage	Factor
220V	X 1.00
230V	X 1.05
240V	X 1.09

The sustained current value is constant irrespective of voltage level

# UCM224G



## Winding 06

### RATINGS

Class - Temp Rise		Cont. B - 70/50°C 0.8pf			Cont. F - 90/50°C 0.8pf			Cont. H - 110/50°C 0.8pf		
<b>60Hz</b>	Series (V)	220	230	240	220	230	240	220	230	240
	Parallel (V)	110	115	120	110	115	120	110	115	120
	kVA	49.5	49.5	49.5	56.3	56.3	56.3	63.0	63.0	63.0
	kW	39.6	39.6	39.6	45.0	45.0	45.0	50.4	50.4	50.4
	Efficiency (%)	85.2	85.5	85.7	84.8	85.2	85.5	84.3	84.7	85.1
	kW Input	46.5	46.3	46.2	53.1	52.9	52.7	59.8	59.5	59.2

Class - Temp Rise		Cont. B - 70/50°C 1.0pf			Cont. F - 90/50°C 1.0pf			Cont. H - 110/50°C 1.0pf		
<b>60Hz</b>	Series (V)	220	230	240	220	230	240	220	230	240
	Parallel (V)	110	115	120	110	115	120	110	115	120
	kVA	49.5	49.5	49.5	56.3	56.3	56.3	63.0	63.0	63.0
	kW	49.5	49.5	49.5	56.3	56.3	56.3	63.0	63.0	63.0
	Efficiency (%)	88.4	88.7	88.9	88.0	88.4	88.6	87.6	88.0	88.3
	kW Input	56.0	55.8	55.7	64.0	63.7	63.5	71.9	71.6	71.3

### DIMENSIONS

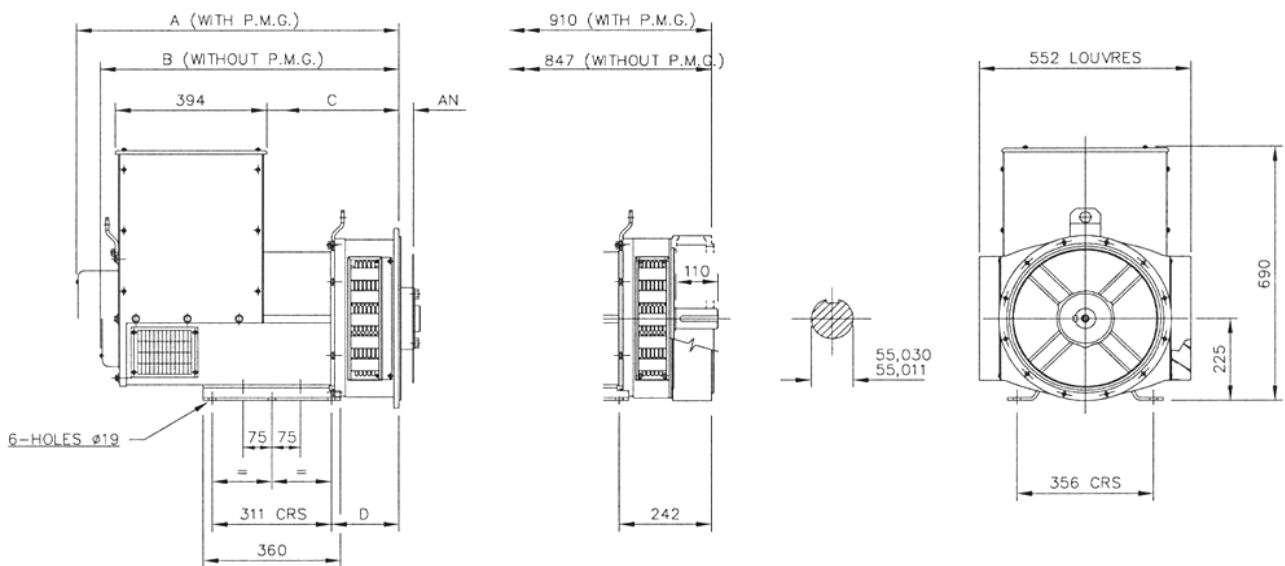

SINGLE BEARING ADAPTORS				
ADAPTOR	A	B	C	D
SAE 1	859,3	796,3	359,3	191,3
SAE 2	845	782	345	177
SAE 3	845	782	345	177
SAE 4	845	782	345	177

COUPLING DISCS	
DISC	AN
SAE 8	61,90
SAE 10	53,98
SAE 11,5	39,68
SAE 14	25,40

APPROVED DOCUMENT

**STAMFORD**

Head Office Address:  
Barnack Road, Stamford  
Lincolnshire, PE9 2NB  
United Kingdom  
Tel: +44 (0) 1780 484000  
Fax: +44 (0) 1780 484100

[www.cumminsgeneratortechnologies.com](http://www.cumminsgeneratortechnologies.com)

Copyright 2010, Cummins Generator Technologies Ltd, All Rights Reserved  
Stamford and AvK are registered trade marks of Cummins Generator Technologies Ltd  
Cummins and the Cummins logo are registered trade marks of Cummins Inc.