

S4L1M-C41 Wdg.14 - Technical Data Sheet

Standards

STAMFORD industrial alternators meet the requirements of the relevant parts of the IEC EN 60034 and the relevant section of other international standards such as BS5000, VDE 0530, NEMA MG1-32, IEC34, CSA C22.2-100 and As1359. Other standards and certifications can be considered on request.

Quality Assurance

Alternators are manufactured using production procedures having a quality assurance level to BS EN ISO 9001.

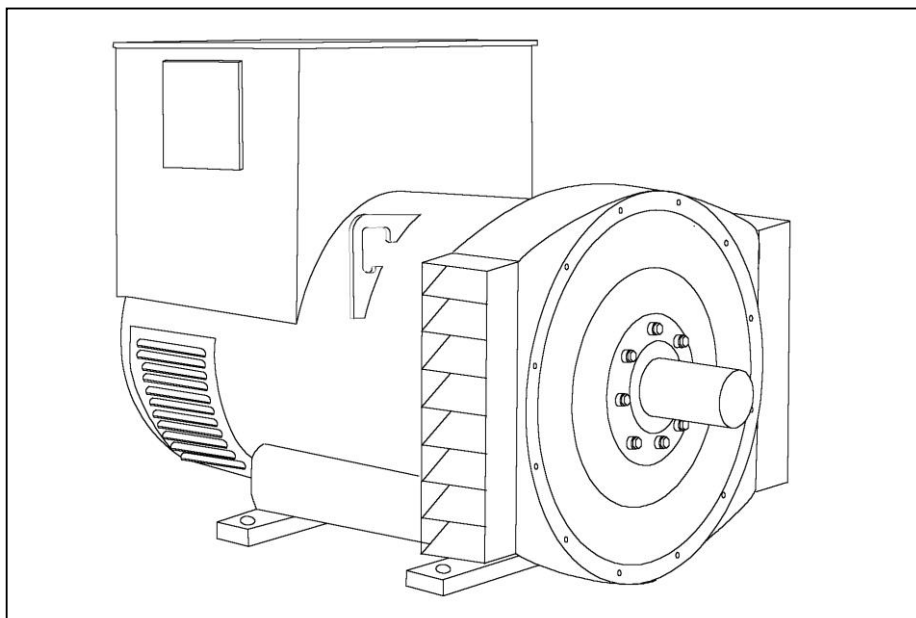

Excitation and Voltage Regulators

Excitation System					
AVR Type	MX341	MX321			
Voltage Regulation	± 1.0%	± 0.5%			with 4% Engine Governing
AVR Power	PMG	PMG			

No Load Excitation Voltage (V)	12 - 9
No Load Excitation Current (A)	0.7 - 0.5
Full Load Excitation Voltage (V)	43 - 40
Full Load Excitation Current (A)	2.4 - 2.2
Exciter Time Constant (seconds)	0.105

STAMFORD®

S4L1M-C41 Wdg.14

Electrical Data			
Insulation System	CLASS H		
Stator Winding	DOUBLE LAYER LAP		
Winding Pitch	TWO THIRDS		
Winding Leads	12		
Winding Number	14		
Number of Poles	4		
IP Rating	IP23		
RFI Suppression	BS EN 61000-6-2 & BS EN 61000-6-4, VDE 0875G, VDE 0875N. Refer to factory for others		
Waveform Distortion	NO LOAD < 1.5% NON-DISTORTING BALANCED LINEAR LOAD < 5.0%		
Short Circuit Ratio	1/Xd		
Steady State X/R Ratio	10.6		
60 Hz			
Telephone Interference	TIF<50		
Cooling Air	0.99 m³/sec 2100cfm		
Voltage Star	380	400	416
kVA Base Rating (CLASS H) for Reactance Values	265	265	265
Saturated Values in Per Unit at Base Ratings and Voltages			
Xd Dir. Axis Synchronous	2.67	2.41	2.23
X'd Dir. Axis Transient	0.18	0.16	0.15
X''d Dir. Axis Subtransient	0.12	0.11	0.10
Xq Quad. Axis Reactance	2.31	2.08	1.93
X''q Quad. Axis Subtransient	0.30	0.27	0.25
XL Stator Leakage Reactance	0.08	0.07	0.07
X2 Negative Sequence Reactance	0.21	0.19	0.18
X0 Zero Sequence Reactance	0.07	0.06	0.06
Unsaturated Values in Per Unit at Base Ratings and Voltages			
Xd Dir. Axis Synchronous	3.20	2.89	2.67
X'd Dir. Axis Transient	0.21	0.19	0.18
X''d Dir. Axis Subtransient	0.14	0.13	0.12
Xq Quad. Axis Reactance	2.38	2.15	2.31
X''q Quad. Axis Subtransient	0.36	0.32	0.30
XL Stator Leakage Reactance	0.09	0.08	0.08
Xlr Rotor Leakage Reactance	0.12	0.11	0.10
X2 Negative Sequence Reactance	0.25	0.23	0.21
X0 Zero Sequence Reactance	0.08	0.07	0.07

STAMFORD

S4L1M-C41 Wdg.14

Time Constants (Seconds)																																		
T'd TRANSIENT TIME CONST.	0.08																																	
T''d SUB-TRANSTIME CONST.	0.019																																	
T'do O.C. FIELD TIME CONST.	1.7																																	
Ta ARMATURE TIME CONST.	0.018																																	
T''q SUB-TRANSTIME CONST.	0.0304																																	
Resistances in Ohms (Ω) at 22^oC																																		
Stator Winding Resistance (Ra), per phase for series connected	0.011																																	
Rotor Winding Resistance (Rf)	0.92																																	
Exciter Stator Winding Resistance	18																																	
Exciter Rotor Winding Resistance per phase	0.068																																	
PMG Phase Resistance (Rpmg) per phase	1.9																																	
Positive Sequence Resistance (R1)	0.01375																																	
Negative Sequence Resistance (R2)	0.01584																																	
Zero Sequence Resistance (R0)	0.01375																																	
Saturation Factors																																		
	380V																																	
SG1.0	0.19																																	
SG1.2	0.88																																	
Mechanical Data																																		
Shaft and Keys	All alternator rotors are dynamically balanced to better than BS6861: Part 1 Grade 2.5 for minimum vibration in operation. Two bearing generators are balanced with a half key.																																	
	<table border="1"> <thead> <tr> <th></th> <th>1 Bearing</th> <th>2 Bearings</th> </tr> </thead> <tbody> <tr> <td>SAE Adaptor</td> <td>SAE 0, 0.5, 1, 2</td> <td>SAE 0, 0.5, 1, 2</td> </tr> <tr> <td>Moment of Inertia</td> <td>3.5531kgm²</td> <td>3.3543kgm²</td> </tr> <tr> <td>Weight Wound Stator</td> <td>370kg</td> <td>370kg</td> </tr> <tr> <td>Weight Wound Rotor</td> <td>324kg</td> <td>301kg</td> </tr> <tr> <td>Weight Complete Alternator</td> <td>850kg</td> <td>885kg</td> </tr> <tr> <td>Shipping weight in a Crate</td> <td>920kg</td> <td>945kg</td> </tr> <tr> <td>Packing Crate Size</td> <td>155 x 87 x 107 (cm)</td> <td>155 x 87 x 107 (cm)</td> </tr> <tr> <td>Maximum Over Speed</td> <td colspan="2">2250 RPM for two minutes</td> </tr> <tr> <td>Bearing Drive End</td> <td colspan="2">BALL. 6317 (ISO)</td> </tr> <tr> <td>Bearing Non-Drive End</td> <td colspan="2">BALL. 6314 (ISO)</td> </tr> </tbody> </table>		1 Bearing	2 Bearings	SAE Adaptor	SAE 0, 0.5, 1, 2	SAE 0, 0.5, 1, 2	Moment of Inertia	3.5531kgm ²	3.3543kgm ²	Weight Wound Stator	370kg	370kg	Weight Wound Rotor	324kg	301kg	Weight Complete Alternator	850kg	885kg	Shipping weight in a Crate	920kg	945kg	Packing Crate Size	155 x 87 x 107 (cm)	155 x 87 x 107 (cm)	Maximum Over Speed	2250 RPM for two minutes		Bearing Drive End	BALL. 6317 (ISO)		Bearing Non-Drive End	BALL. 6314 (ISO)	
	1 Bearing	2 Bearings																																
SAE Adaptor	SAE 0, 0.5, 1, 2	SAE 0, 0.5, 1, 2																																
Moment of Inertia	3.5531kgm ²	3.3543kgm ²																																
Weight Wound Stator	370kg	370kg																																
Weight Wound Rotor	324kg	301kg																																
Weight Complete Alternator	850kg	885kg																																
Shipping weight in a Crate	920kg	945kg																																
Packing Crate Size	155 x 87 x 107 (cm)	155 x 87 x 107 (cm)																																
Maximum Over Speed	2250 RPM for two minutes																																	
Bearing Drive End	BALL. 6317 (ISO)																																	
Bearing Non-Drive End	BALL. 6314 (ISO)																																	
SAE Adaptor	SAE 0, 0.5, 1, 2	SAE 0, 0.5, 1, 2																																
Moment of Inertia	3.5531kgm ²	3.3543kgm ²																																
Weight Wound Stator	370kg	370kg																																
Weight Wound Rotor	324kg	301kg																																
Weight Complete Alternator	850kg	885kg																																
Shipping weight in a Crate	920kg	945kg																																
Packing Crate Size	155 x 87 x 107 (cm)	155 x 87 x 107 (cm)																																
Maximum Over Speed	2250 RPM for two minutes																																	
Bearing Drive End	BALL. 6317 (ISO)																																	
Bearing Non-Drive End	BALL. 6314 (ISO)																																	

STAMFORD®

S4L1M-C41 Wdg.14

THREE PHASE EFFICIENCY CURVES

60Hz

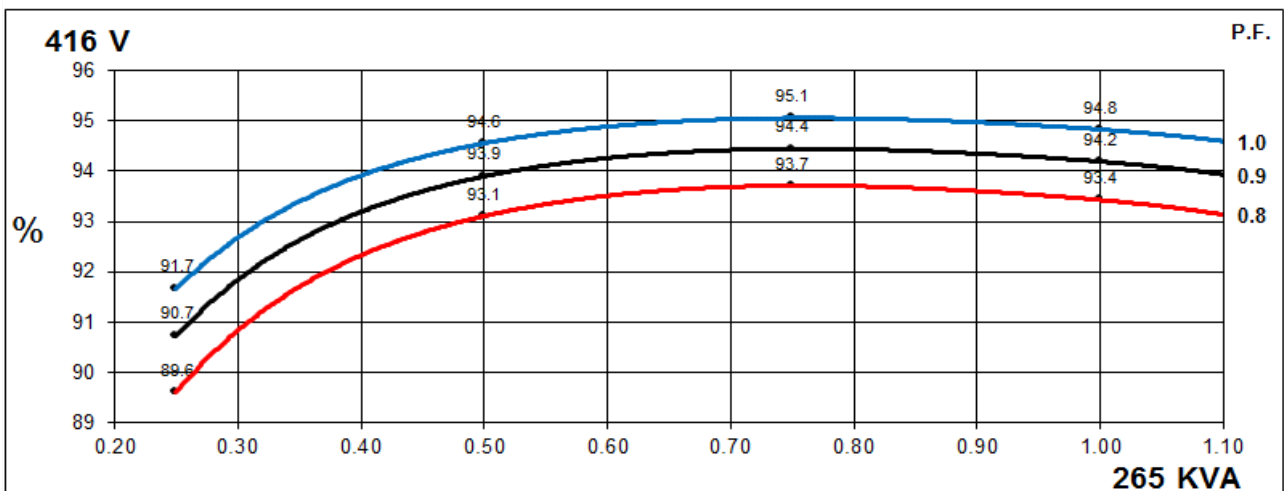
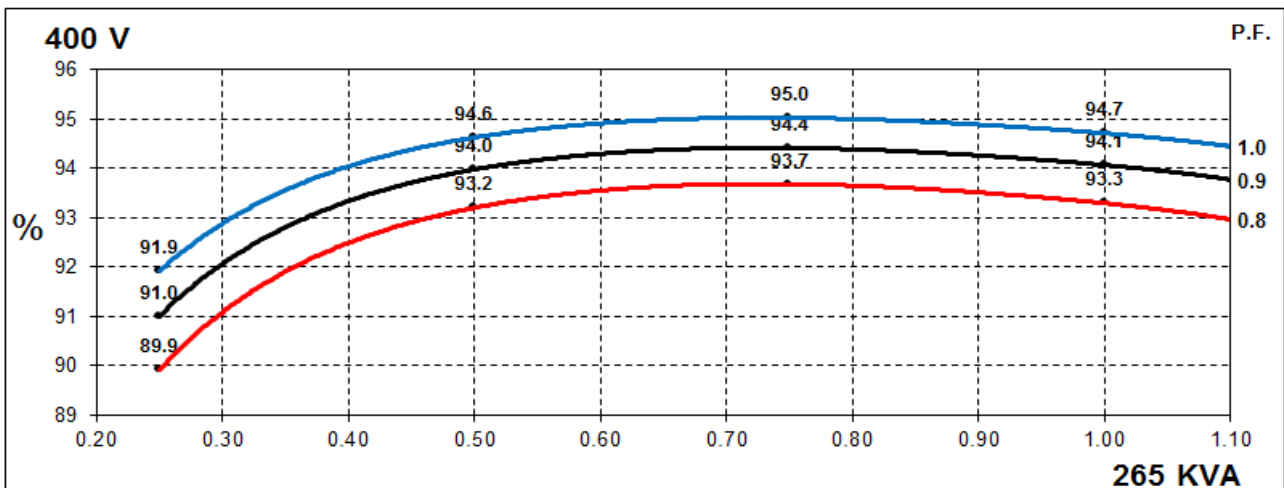
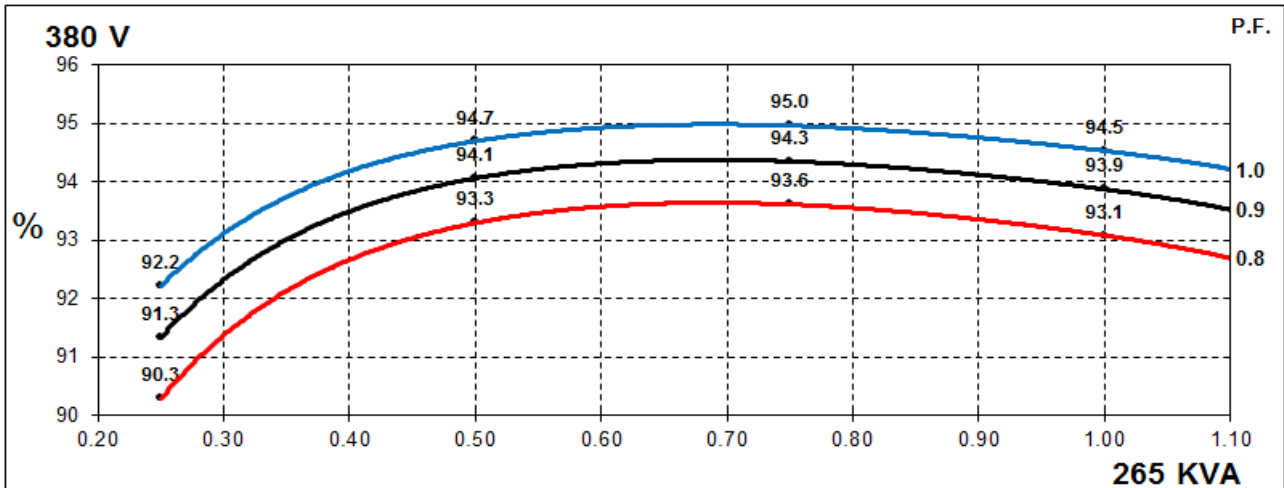

STAMFORD®

S4L1M-C41 Wdg.14

Locked Rotor Motor Starting Curves

60Hz

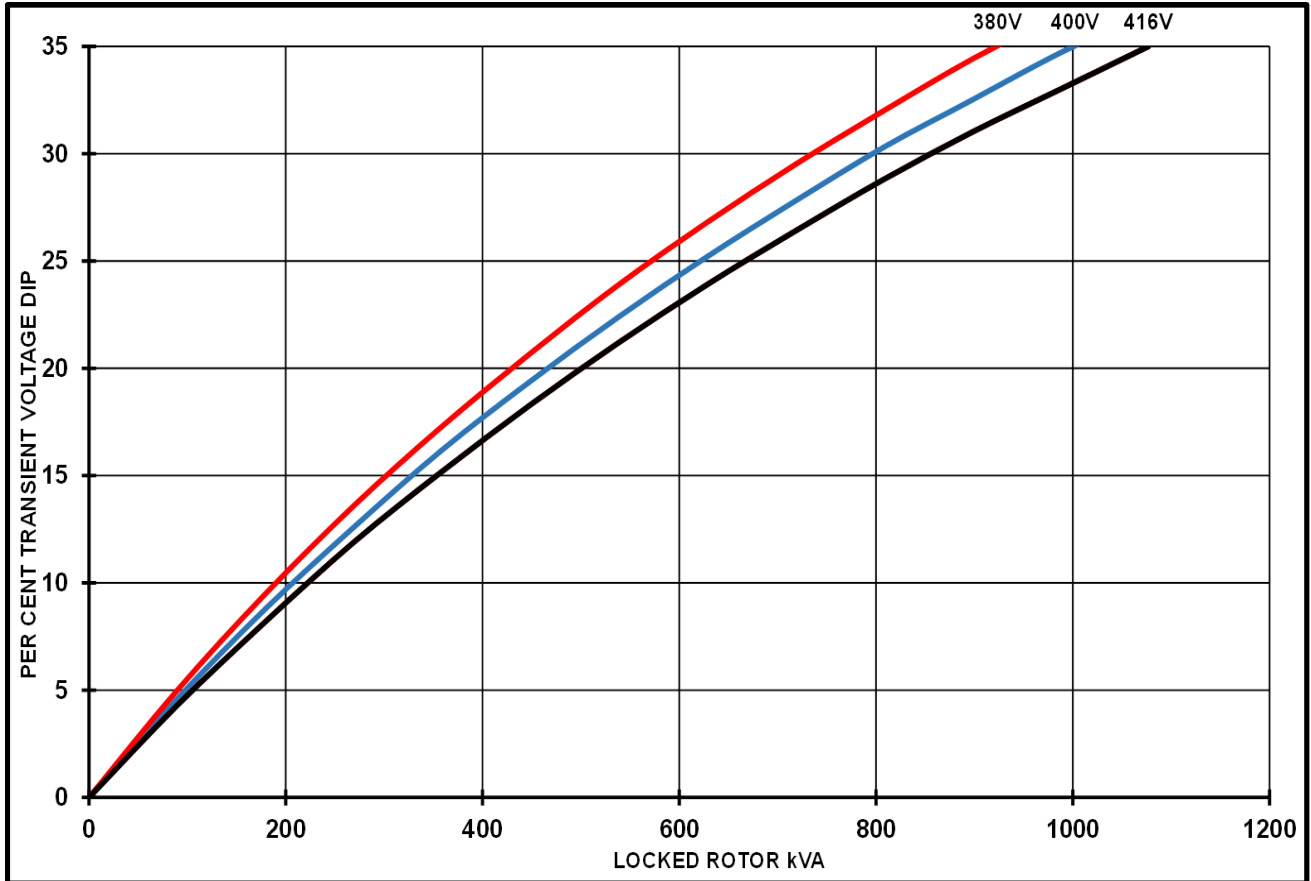

Transient Voltage Dip Scaling Factor		Transient Voltage Rise Scaling Factor
PF	Factor	
< 0.5	1	For voltage rise multiply voltage dip by 1.25
0.5	0.97	
0.6	0.93	
0.7	0.9	
0.8	0.85	
0.9	0.83	

STAMFORD®

S4L1M-C41 Wdg.14

Three-phase Short Circuit Decrement Curve

60Hz

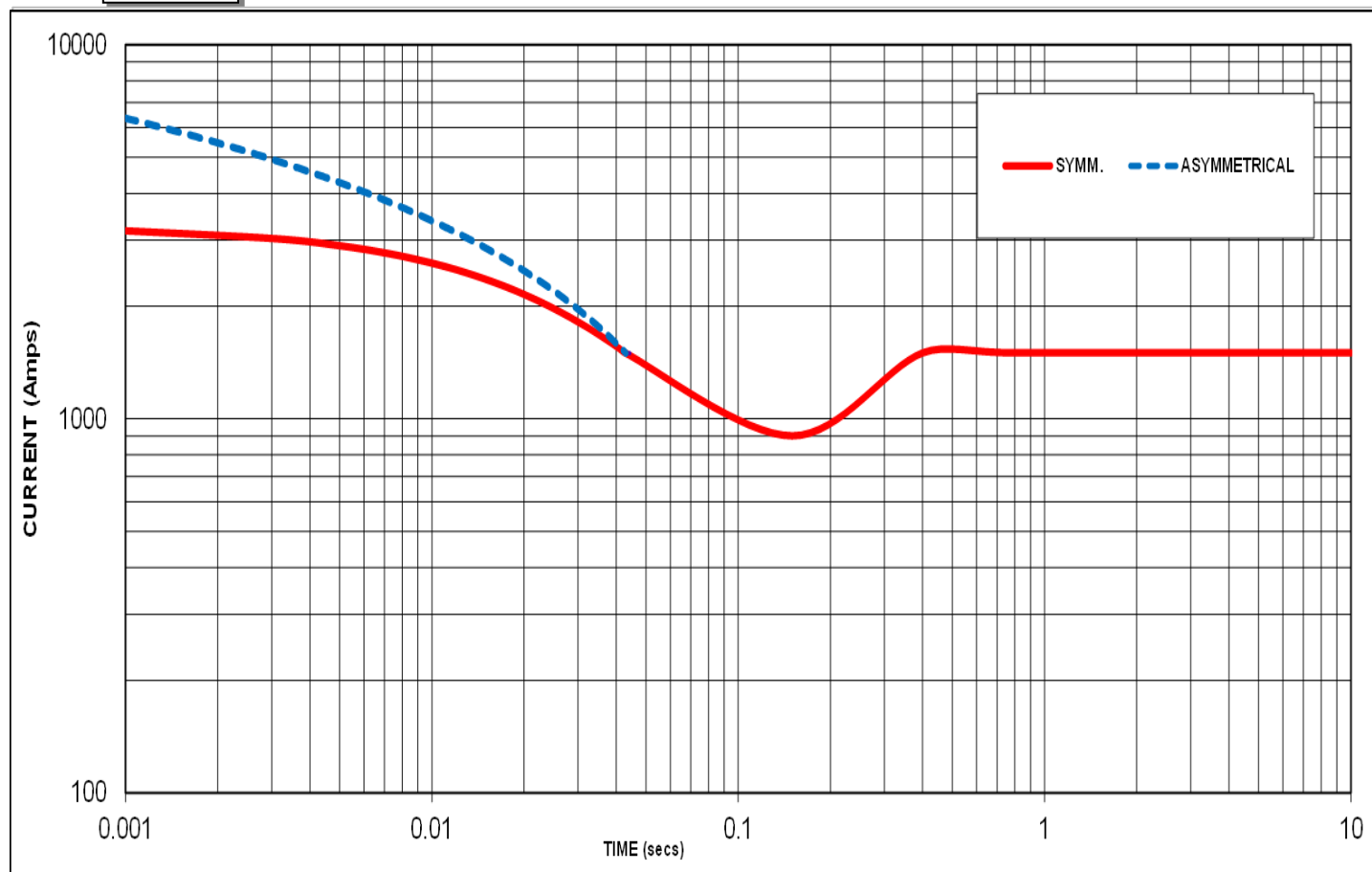

Sustained Short Circuit = 1500 Amps

Note 1

The following multiplication factors should be used to adjust the values from curve between time 0.001 seconds and the minimum current point in respect of nominal operating voltage :

60Hz	
Voltage	Factor
380V	X 1.00
400V	X 1.05
415V	X 1.09

The sustained current value is constant irrespective of voltage level

Note 2

The following multiplication factor should be used to convert the values calculated in accordance with NOTE 1 to those applicable to the various types of short circuit :

	3-phase	2-phase L-L	1-phase L-N
Instantaneous	x 1.00	x 0.87	x 1.30
Minimum	x 1.00	x 1.80	x 3.20
Sustained	x 1.00	x 1.50	x 2.50
Max. sustained duration	10 sec.	5 sec.	2 sec.

All other times are unchanged

Note 3

Curves are drawn for Star connected machines under no-load excitation at rated speeds. For other connection the following multipliers should be applied to current values as shown :

Parallel Star = Curve current value X 2
 Series Delta = Curve current value X 1.732

STAMFORD

S4L1M-C41 Wdg.14

Typical Alternator Operating Charts

380V/60Hz

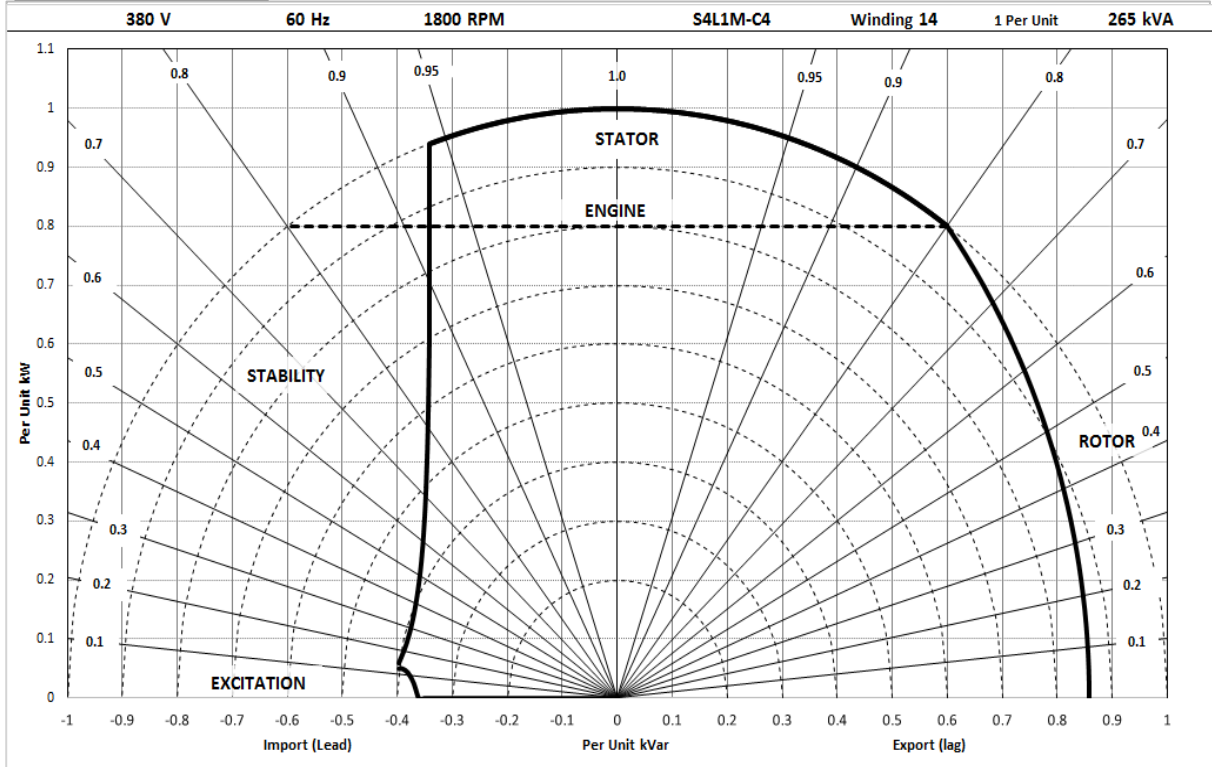

416V/60Hz

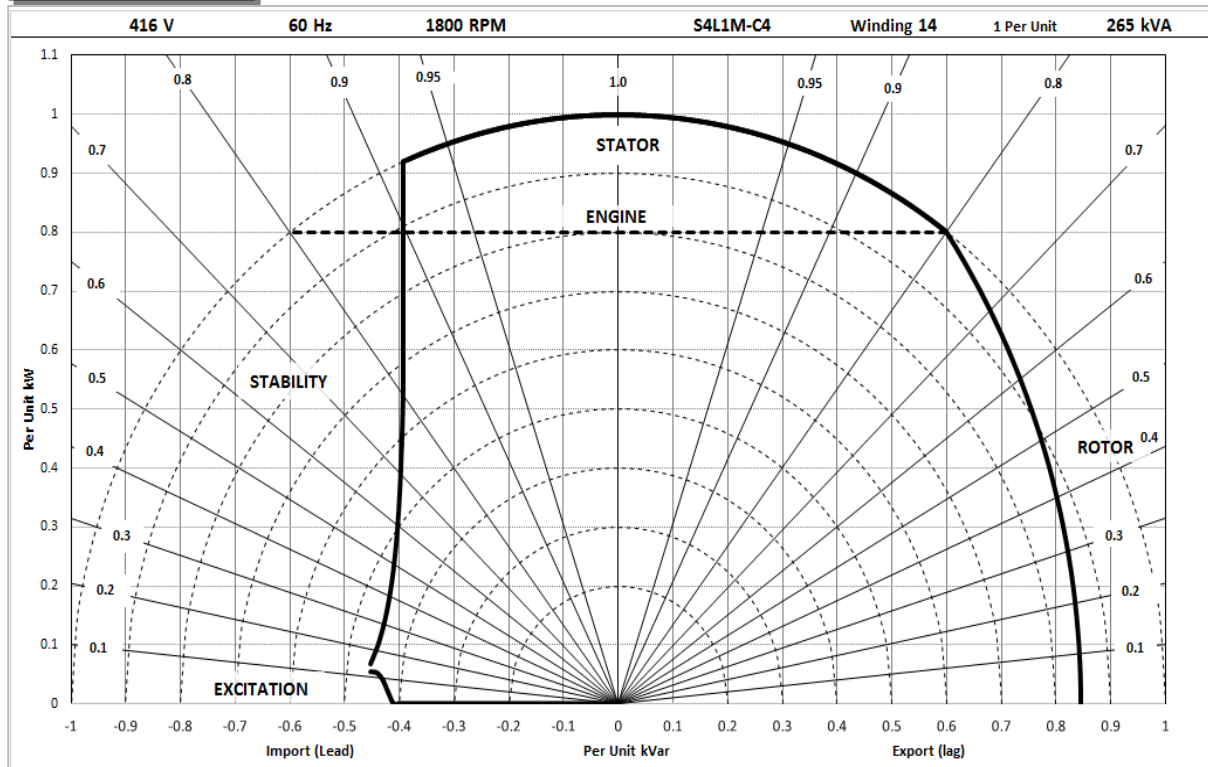

STAMFORD®

S4L1M-C41 Wdg.14

RATINGS AT 0.8 POWER FACTOR

Class - Temp Rise		Cont. H - 110/50°C			Cont. F - 90/50°C			Cont. B - 70/50°C		
60 Hz	Series Star (V)	380	400	416	380	400	416	380	400	416
	kVA	265	265	265	250	250	250	220	220	220
	kW	212	212	212	200	200	200	176	176	176
	Efficiency (%)	93.1	93.3	93.4	93.3	93.4	93.5	93.5	93.6	93.7
	kW Input	228	227	227	214	214	214	188	188	188

De-Rates

All values tabulated above are subject to the following reductions:

- 5% when air inlet filters are fitted
- 3% for every 500 meters by which the operating altitude exceeds 1000 meters above mean sea level
- 3% for every 5°C by which the operational ambient temperature exceeds 40°C
- For any other operating conditions impacting the cooling circuit please refer to applications

Note: Requirement for operating in an ambient exceeding 60°C and altitude exceeding 4000 meters must be referred to applications.

Dimensional and Torsional Drawing

For dimensional and torsional information please refer to the alternator General Arrangement and rotor drawings available on our website (<http://stamford-avk.com/>)

Note: Continuous development of our products means that the information contained in our data sheets can change without notice, and specifications should always be confirmed with Cummins Generator Technologies prior to purchase.



Follow us @stamfordavk



Cummins Generator Technologies



View our videos at youtube.com/stamfordavk

news.stamford-avk.com

For Applications Support:
applications@cummins.com

For Customer Service:
service-engineers@stamford-avk.com

For General Enquiries:
info@cumminsgeneratortechnologies.com

Copyright 2016. Cummins Generator Technologies Ltd. All rights reserved.
Cummins and the Cummins logo are registered trade marks of Cummins Inc.
STAMFORD is a registered trade mark of Cummins Generator Technologies Ltd.

