

# STAMFORD®

## S5L1M-F4 Wdg.14 - Technical Data Sheet

### Standards

STAMFORD industrial alternators meet the requirements of the relevant parts of the IEC EN 60034 and the relevant section of other international standards such as BS5000, VDE 0530, NEMA MG1-32, IEC34, CSA C22.2-100 and AS1359. Other standards and certifications can be considered on request.

### Quality Assurance

Alternators are manufactured using production procedures having a quality assurance level to BS EN ISO 9001.

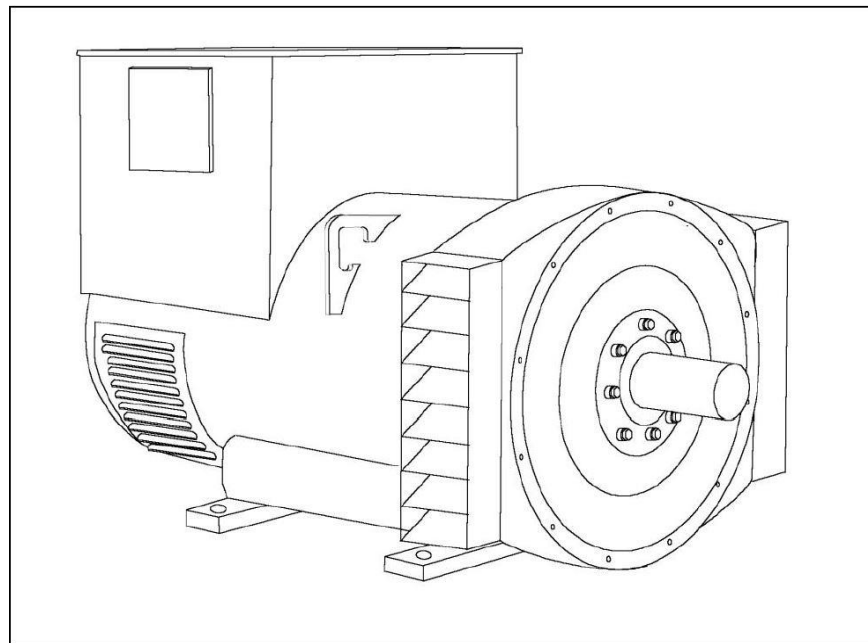

### Excitation and Voltage Regulators

Excitation System					
AVR Type	MX341	MX321			
Voltage Regulation	± 1%	± 0.5%			with 4% Engine Governing
AVR Power	PMG	PMG			

No Load Excitation Voltage (V)	9.59
No Load Excitation Current (A)	0.56
Full Load Excitation Voltage (V)	36.39
Full Load Excitation Current (A)	2.22
Exciter Time Constant (seconds)	0.099

# STAMFORD

## S5L1M-F4 Wdg.14

Electrical Data				
Insulation System	H			
Stator Winding	Double Layer Lap			
Winding Pitch	2/3			
Winding Leads	12			
Winding Number	14			
Number of Poles	4			
IP Rating	IP23			
RFI Suppression	BS EN 61000-6-2 & BS EN 61000-6-4, VDE 0875G, VDE 0875N. Refer to factory for others			
Waveform Distortion	NO LOAD < 1.5% NON-DISTORTING BALANCED LINEAR LOAD < 5.0%			
Short Circuit Ratio	1/Xd			
Steady State X/R Ratio	21.27			
60 Hz				
Telephone Interference	TIF<50			
Cooling Air Flow	1.312 m <sup>3</sup> /sec			
Voltage Series Star (V)	380	400	416	-
Voltage Parallel Star (V)	190	200	208	-
Voltage Series Delta (V)	220	230	240	-
kVA Base Rating (Class H) for Reactance Values (kVA)	725	725	725	-
Saturated Values in Per Unit at Base Ratings and Voltages				
Xd Dir. Axis Synchronous	2.73	2.46	2.27	-
X'd Dir. Axis Transient	0.12	0.11	0.10	-
X''d Dir. Axis Subtransient	0.09	0.08	0.07	-
Xq Quad. Axis Reactance	2.18	1.97	1.82	-
X''q Quad. Axis Subtransient	0.25	0.23	0.21	-
XL Stator Leakage Reactance	0.04	0.04	0.04	-
X2 Negative Sequence Reactance	0.18	0.16	0.15	-
X0 Zero Sequence Reactance	0.08	0.07	0.06	-
Unsaturated Values in Per Unit at Base Ratings and Voltages				
Xd Dir. Axis Synchronous	3.27	2.95	2.73	-
X'd Dir. Axis Transient	0.14	0.13	0.12	-
X''d Dir. Axis Subtransient	0.10	0.09	0.09	-
Xq Quad. Axis Reactance	2.25	2.03	1.88	-
X''q Quad. Axis Subtransient	0.31	0.28	0.26	-
XL Stator Leakage Reactance	0.05	0.05	0.04	-
Xlr Rotor Leakage Reactance	0.08	0.07	0.06	-
X2 Negative Sequence Reactance	0.21	0.19	0.18	-
X0 Zero Sequence Reactance	0.09	0.08	0.08	-

# STAMFORD

## S5L1M-F4 Wdg.14

Time Constants (Seconds)		
T'd Transient Time Const.	0.08	
T''d Sub-Transient Time Const.	0.0120	
T'do O.C. Field Time Const.	2.5	
Ta Armature Time Const.	0.0190	
T''q Sub-Transient Time Const.	0.0190	
Resistances in Ohms ( $\Omega$ ) at 22°C		
Stator Winding Resistance (Ra), per phase for series connected	0.0025	
Rotor Winding Resistance (Rf)	2.16	
Exciter Stator Winding Resistance	17	
Exciter Rotor Winding Resistance per phase	0.092	
PMG Phase Resistance (Rpmg) per phase	1.9	
Positive Sequence Resistance (R1)	0.0031	
Negative Sequence Resistance (R2)	0.0036	
Zero Sequence Resistance (R0)	0.0031	
Saturation Factors		
	400V	
SG1.0	0.41	
SG1.2	2	
Mechanical Data		
Shaft and Keys	All alternator rotors are dynamically balanced to better than BS6861: Part 1 Grade 2.5 for minimum vibration in operation. Two bearing generators are balanced with a half key.	
	1 Bearing	2 Bearing
SAE Adaptor	SAE 00, 0, 0.5, 1	SAE 00, 0, 0.5, 1
Moment of Inertia	10.033 kgm <sup>2</sup>	9.7551 kgm <sup>2</sup>
Weight Wound Stator	805kg	805kg
Weight Wound Rotor	684kg	655kg
Weight Complete Alternator	1685kg	1694kg
Shipping weight in a Crate	1775kg	1780kg
Packing Crate Size	166x87x124(cm)	166x87x124(cm)
Maximum Over Speed	2250 RPM for two minutes	
Bearing Drive End	-	BALL.6220(ISO)
Bearing Non-Drive End	BALL.6314(ISO)	BALL.6314(ISO)

# STAMFORD®

S5L1M-F4 Wdg.14

## THREE PHASE EFFICIENCY CURVES

60Hz

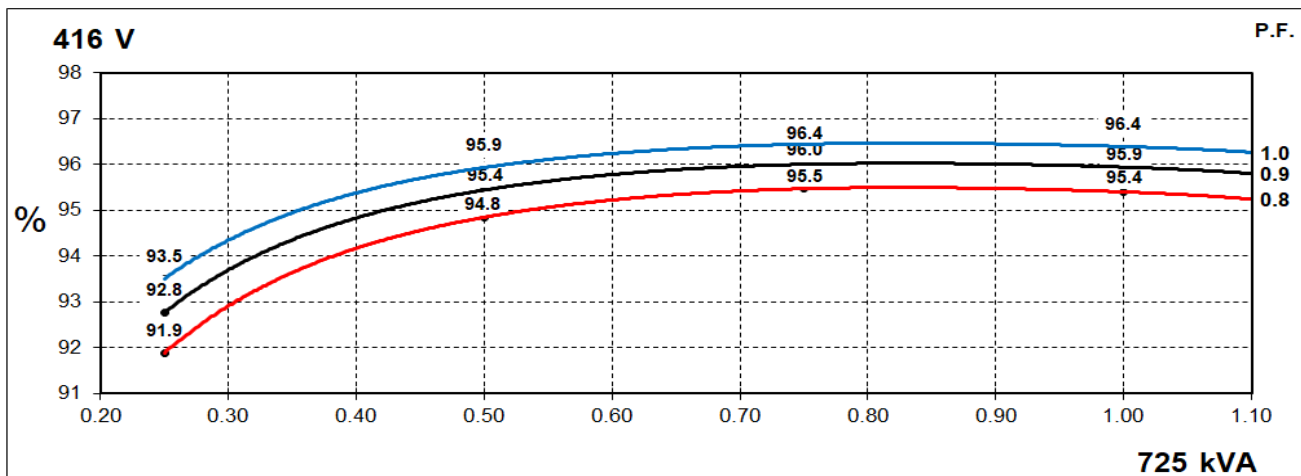
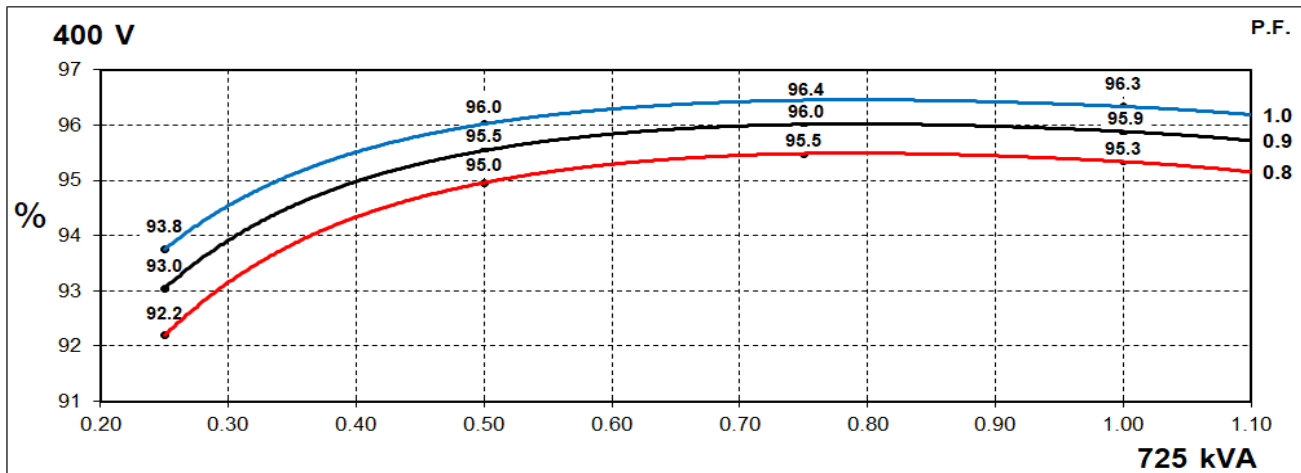
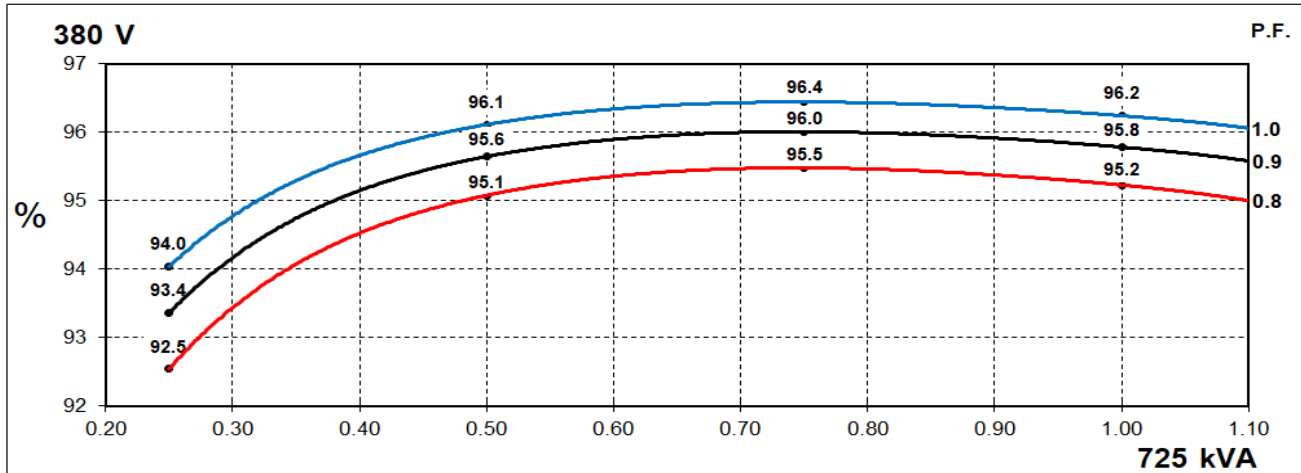

# STAMFORD

S5L1M-F4 Wdg.14

## Locked Rotor Motor Starting Curves - Separately Excited

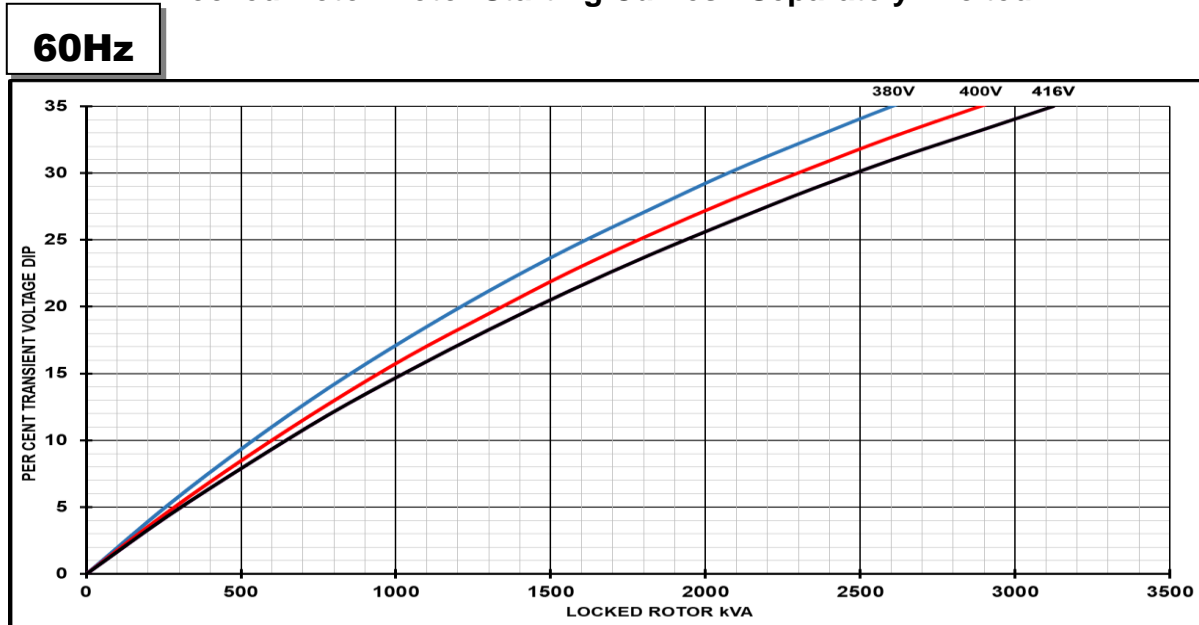

Transient Voltage Dip Scaling Factor		Transient Voltage Rise Scaling Factor
PF	Factor	For voltage rise multiply voltage dip by 1.25
< 0.5	1	
0.5	0.97	
0.6	0.93	
0.7	0.9	
0.8	0.85	
0.9	0.83	

# STAMFORD®

## S5L1M-F4 Wdg.14

### Three-phase Short Circuit Decrement Curve - Separately Excited

**60Hz**

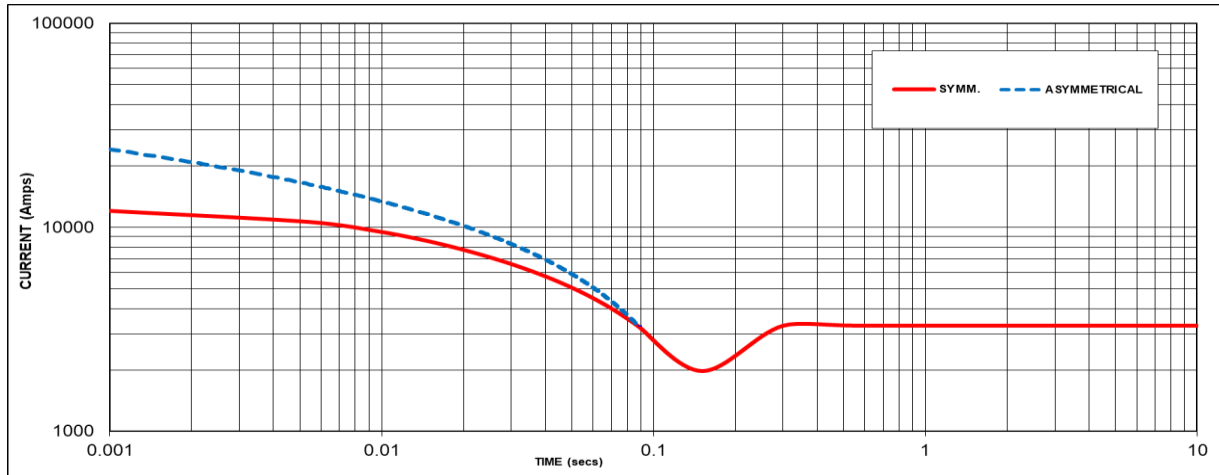

Sustained Short Circuit = 3300 Amps

**Note 1**

The following multiplication factors should be used to adjust the values from curve between time 0.001 seconds and the minimum current point in respect of nominal operating voltage :

50Hz		60Hz	
Voltage	Factor	Voltage	Factor
-	-	380V	X 1.00
-	-	400V	X 1.06
-	-	416V	X 1.10
-	-	-	-

The sustained current value is constant irrespective of voltage level

**Note 2**

The following multiplication factor should be used to convert the values calculated in accordance with NOTE 1 to those applicable to the various types of short circuit :

	3-phase	2-phase L-L	1-phase L-N
Instantaneous	x 1.00	x 0.87	x 1.30
Minimum	x 1.00	x 1.80	x 3.20
Sustained	x 1.00	x 1.50	x 2.50
Max. sustained duration	10 sec.	5 sec.	2 sec.

**Note 3**

All other times are unchanged  
 Curves are drawn for Star connections under no-load excitation at rated speeds. For other connection (where applicable) the following multipliers should be applied to current values as shown :  
 Parallel Star = Curve current value X 2  
 Series Delta = Curve current value X 1.732

# STAMFORD

S5L1M-F4 Wdg.14

## Typical Alternator Operating Charts

**400V/60Hz**

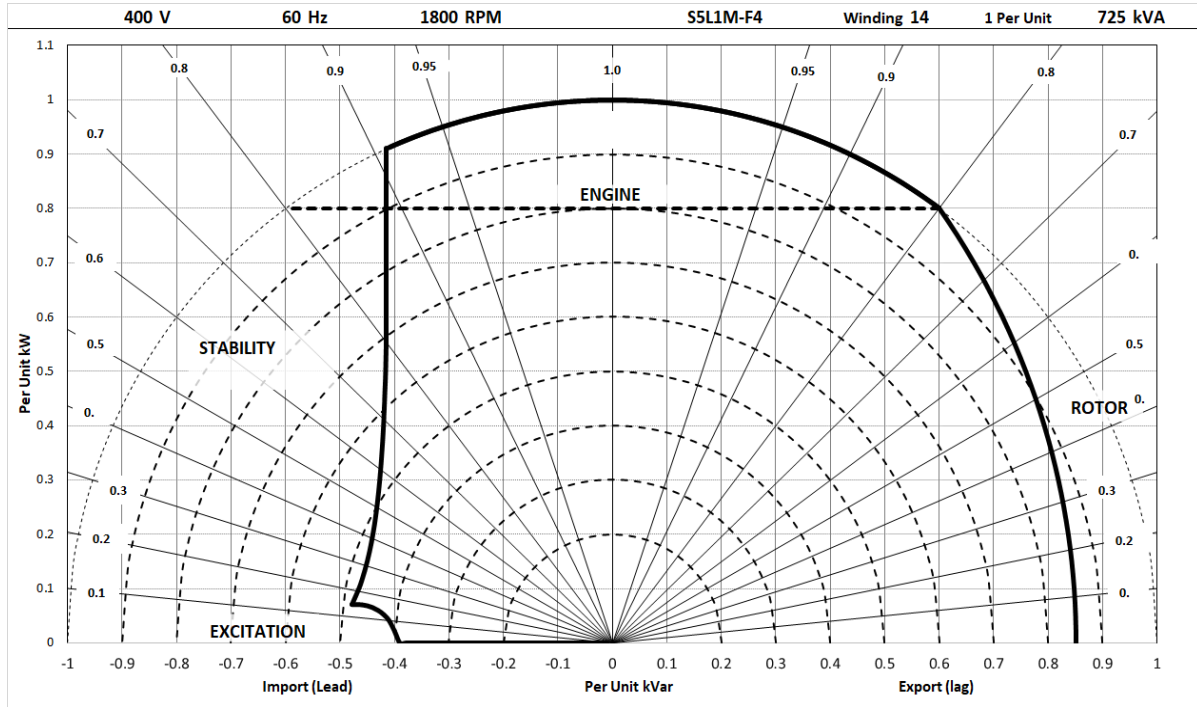

# STAMFORD®

## S5L1M-F4 Wdg.14

### RATINGS AT 0.8 POWER FACTOR

Class - Temp Rise		Standby	Cont. H - 110/50°C	Cont. F - 90/50°C	Cont. B - 70/50°C
<b>50</b> Hz	Series Star (V)	N/A	N/A	N/A	N/A
	Parallel Star (V)	N/A	N/A	N/A	N/A
	Series Delta (V)	N/A	N/A	N/A	N/A
	kVA	N/A	N/A	N/A	N/A
	kW	N/A	N/A	N/A	N/A
	Efficiency (%)	N/A	N/A	N/A	N/A
	kW Input	N/A	N/A	N/A	N/A

<b>60</b> Hz	Series Star (V)	380	400	416	N/A	380	400	416	N/A	380	400	416	N/A	380	400	416	N/A
	Parallel Star (V)	190	200	208	N/A	190	200	208	N/A	190	200	208	N/A	190	200	208	N/A
	Series Delta (V)	220	230	240	N/A	220	230	240	N/A	220	230	240	N/A	220	230	240	N/A
	kVA	N/A	N/A	N/A	N/A	725	725	725	N/A	663	663	663	N/A	582	582	582	N/A
	kW	N/A	N/A	N/A	N/A	580	580	580	N/A	530	530	530	N/A	466	466	466	N/A
	Efficiency (%)	N/A	N/A	N/A	N/A	95.2	95.3	95.4	N/A	95.4	95.4	95.5	N/A	95.5	95.5	95.5	N/A
	kW Input	N/A	N/A	N/A	N/A	609	608	608	N/A	556	556	556	N/A	488	488	488	N/A

#### De-Rates

All values tabulated above are subject to the following reductions:

- 5% when air inlet filters are fitted
- 3% for every 500 meters by which the operating altitude exceeds 1000 meters above mean sea level
- 3% for every 5°C by which the operational ambient temperature exceeds 40°C @ Class H temperature rise (please refer to applications for ambient temperature de-rates at other temperature rise classes)
- For any other operating conditions impacting the cooling circuit please refer to applications

Note: Requirement for operating in an ambient exceeding 60°C and altitude exceeding 4000 meters (for <690V) or 1500 meters (for >690V) must be referred to applications.

#### Dimensional and Torsional Drawing

For dimensional and torsional information please refer to the alternator General Arrangement and rotor drawings available on our website (<http://stamford-avk.com/>)

**Note:** Continuous development of our products means that the information contained in our data sheets can change without notice, and specifications should always be confirmed with Cummins Generator Technologies prior to purchase.





Follow us @stamfordavk



Cummins Generator Technologies



View our videos at [youtube.com/stamfordavk](https://youtube.com/stamfordavk)

**[news.stamford-avk.com](https://news.stamford-avk.com)**

**For Applications Support:  
[applications@cummins.com](mailto:applications@cummins.com)**

**For Customer Service:  
[emea.service@cummins.com](mailto:emea.service@cummins.com)**

**For General Enquiries:  
[Stamford-avk@cummins.com](mailto:Stamford-avk@cummins.com)**

Copyright 2016. Cummins Generator Technologies Ltd. All rights reserved.  
Cummins and the Cummins logo are registered trade marks of Cummins Inc.  
STAMFORD is a registered trade mark of Cummins Generator Technologies Ltd.

