

STAMFORD®

S6L1M-C4 Wdg.13/14 - Technical Data Sheet

Standards

STAMFORD industrial alternators meet the requirements of the relevant parts of the IEC 60034 and the relevant sections of other international standards such as BS5000-3, ISO 8528-3, VDE 0530, NEMA MG1-32, CSA C22.2-100 and AS 60034. Other standards and certifications can be considered on request.

Quality Assurance

Alternators are manufactured using production procedures having a quality assurance level to BS EN ISO 9001.

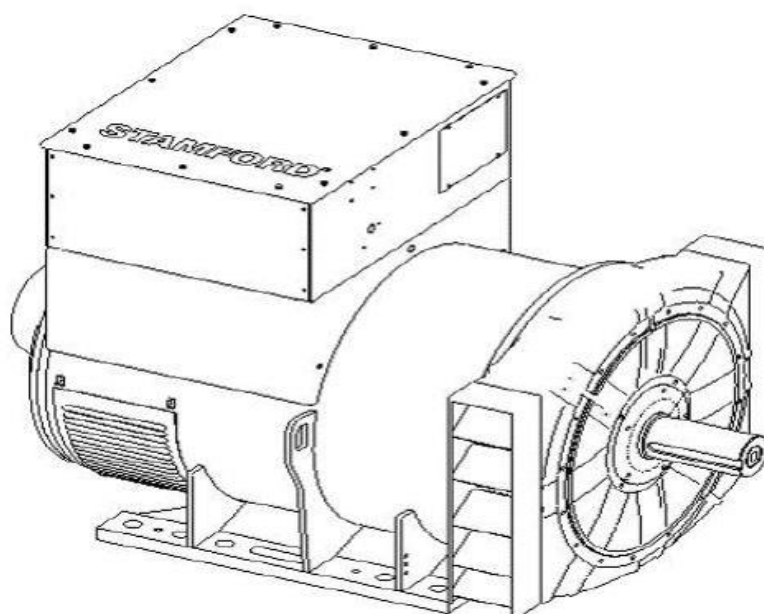

Excitation and Voltage Regulators

Excitation System				
AVR Type	MX321/MX322	MX341	MX321/MX322	
Voltage Regulation	± 0.5%	± 1%	± 0.5%	with 4% Engine Governing
AVR Power	PMG	PMG	PMG	

No Load Excitation Voltage (V)	21.08
No Load Excitation Current (A)	1.14
Full Load Excitation Voltage (V)	56
Full Load Excitation Current (A)	2.7
Exciter Time Constant (seconds)	0.17

STAMFORD

S6L1M-C4 Wdg.13/14

Electrical Data				
Insulation System	H			
Stator Winding	Double Layer Concentric			
Winding Pitch	2/3			
Winding Leads	6/12			
Winding Number	13/14			
Number of Poles	4			
IP Rating	IP23			
RFI Suppression	BS EN 61000-6-2 & BS EN 61000-6-4, VDE 0875G, VDE 0875N. Refer to factory for others			
Waveform Distortion	NO LOAD < 1.5% NON-DISTORTING BALANCED LINEAR LOAD < 5.0%			
Short Circuit Ratio	1/Xd			
Steady State X/R Ratio	18.57			
60 Hz				
Telephone Interference	TIF<50			
Cooling Air Flow	1.37 m³/sec			
Voltage Series Star (V)	380	400	416	-
Voltage Parallel Star (V)	190	200	208	-
Voltage Delta (V)	220	230	240	-
kVA Base Rating (Class H) for Reactance Values (kVA)	788	788	788	-
Saturated Values in Per Unit at Base Ratings and Voltages				
Xd Dir. Axis Synchronous	1.27	1.14	1.06	-
X'd Dir. Axis Transient	0.15	0.13	0.12	-
X''d Dir. Axis Subtransient	0.11	0.10	0.09	-
Xq Quad. Axis Reactance	1.58	1.42	1.32	-
X''q Quad. Axis Subtransient	0.25	0.23	0.21	-
XL Stator Leakage Reactance	0.06	0.06	0.05	-
X2 Negative Sequence Reactance	0.05	0.04	0.04	-
X0 Zero Sequence Reactance	0.01	0.01	0.01	-
Unsaturated Values in Per Unit at Base Ratings and Voltages				
Xd Dir. Axis Synchronous	1.52	1.37	1.27	-
X'd Dir. Axis Transient	0.17	0.15	0.14	-
X''d Dir. Axis Subtransient	0.13	0.12	0.11	-
Xq Quad. Axis Reactance	1.62	1.47	1.36	-
X''q Quad. Axis Subtransient	0.30	0.27	0.25	-
XL Stator Leakage Reactance	0.07	0.06	0.06	-
Xlr Rotor Leakage Reactance	0.07	0.07	0.06	-
X2 Negative Sequence Reactance	0.06	0.05	0.05	-
X0 Zero Sequence Reactance	0.01	0.01	0.01	-

* Parallel Star connection only available with 12 leads winding option

STAMFORD

S6L1M-C4 Wdg.13/14

Time Constants (Seconds)		
T'd Transient Time Const.	0.089	
T''d Sub-Transient Time Const.	0.022	
T'do O.C. Field Time Const.	3.321	
Ta Armature Time Const.	0.025	
T''q Sub-Transient Time Const.	0.0095	
Resistances in Ohms (Ω) at 22°C		
Stator Winding Resistance (Ra), per phase for series connected	0.00200	
Rotor Winding Resistance (Rf)	1.63	
Exciter Stator Winding Resistance	18.47	
Exciter Rotor Winding Resistance per phase	0.095	
PMG Phase Resistance (Rpmg) per phase	1.91	
Positive Sequence Resistance (R1)	0.0025	
Negative Sequence Resistance (R2)	0.0029	
Zero Sequence Resistance (R0)	0.0025	
Saturation Factors		
SG1.0	416V	
SG1.2	1.132	
	4.11	
Mechanical Data		
Shaft and Keys	All alternator rotors are dynamically balanced to better than ISO 21940-11 Grade 2.5 for minimum vibration in operation. Two bearing generators are balanced with a half key.	
	1 Bearing	2 Bearing
SAE Adaptor	SAE0,1	SAE0,1
Moment of Inertia	16.455 kgm ²	15.93 kgm ²
Weight Wound Stator	803kg	803kg
Weight Wound Rotor	721kg	679kg
Weight Complete Alternator	1897kg	1970kg
Shipping weight in a Crate	1940kg	2013kg
Packing Crate Size	160x105x153(cm)	160x105x153(cm)
Maximum Over Speed	2250 RPM for two minutes	
Bearing Drive End	-	BALL 6224
Bearing Non-Drive End	BALL 6317	BALL 6317

STAMFORD

S6L1M-C4 Wdg.13/14

THREE PHASE EFFICIENCY CURVES

60Hz

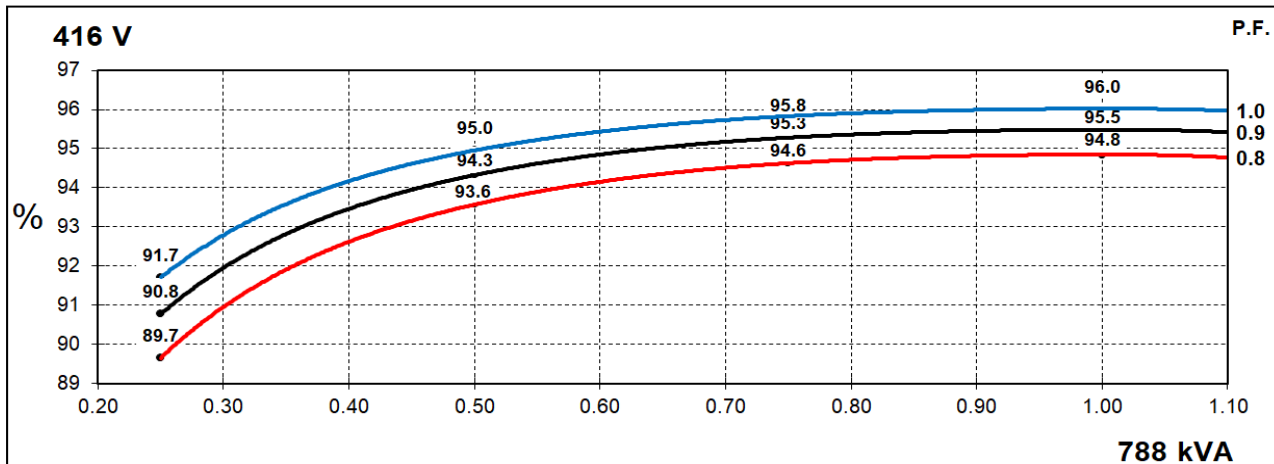
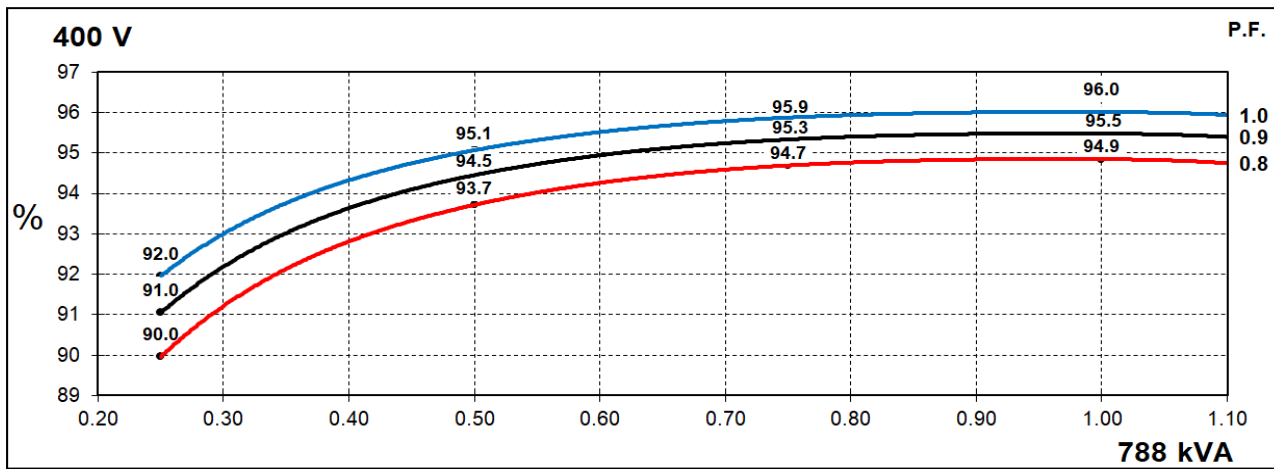
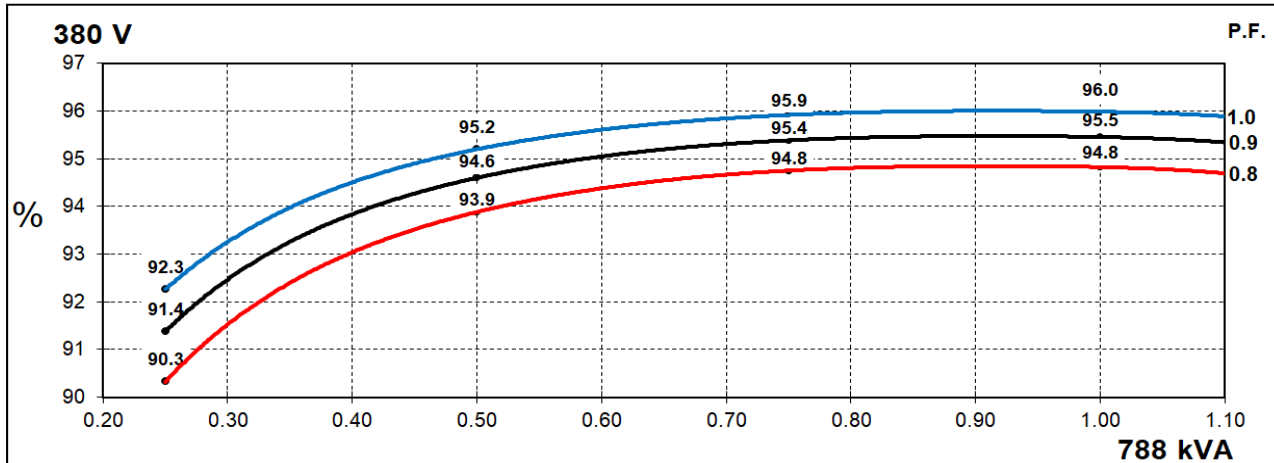

STAMFORD

S6L1M-C4 Wdg.13/14

Locked Rotor Motor Starting Curves - Separately Excited

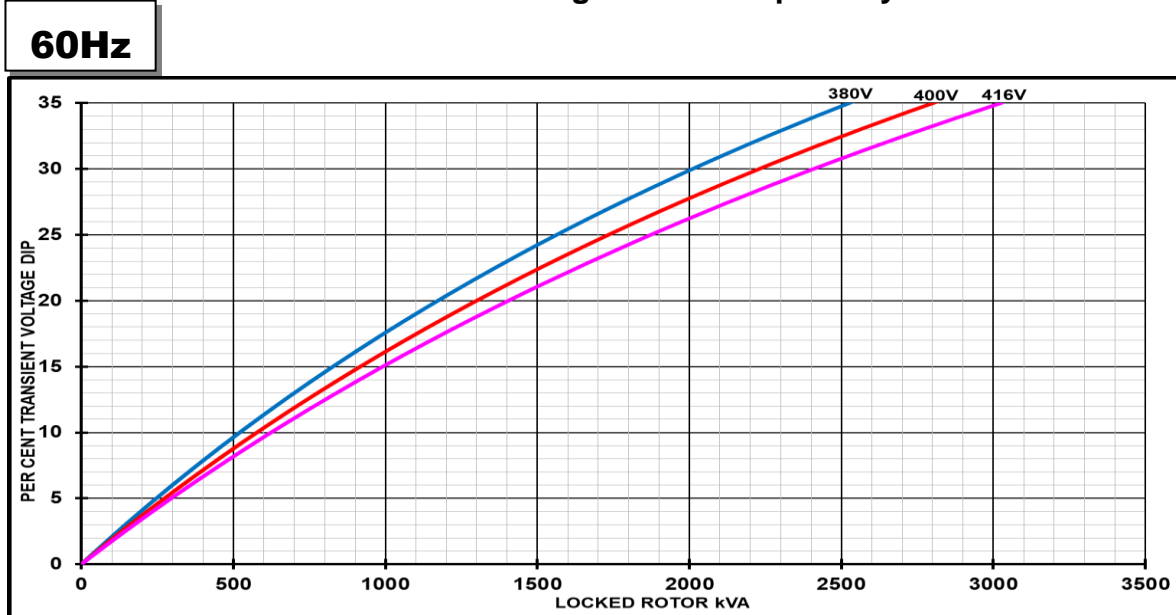

Transient Voltage Dip Scaling Factor		Transient Voltage Rise Scaling Factor	
Lagging PF	Scaling Factor	Lagging PF	Scaling Factor
<= 0.4	1.00	<= 0.4	1.25
0.5	0.95	0.5	1.20
0.6	0.90	0.6	1.15
0.7	0.86	0.7	1.10
0.8	0.83	> 0.7	1.00
0.9	0.75		
0.95	0.70		
1	0.65		

Note: To determine % Transient Voltage Dip or Voltage Rise at various PF, multiply the % Voltage Dip from the curve directly by the Scaling Factor.

STAMFORD®

S6L1M-C4 Wdg.13/14

Three-phase Short Circuit Decrement Curve - Separately Excited

60Hz

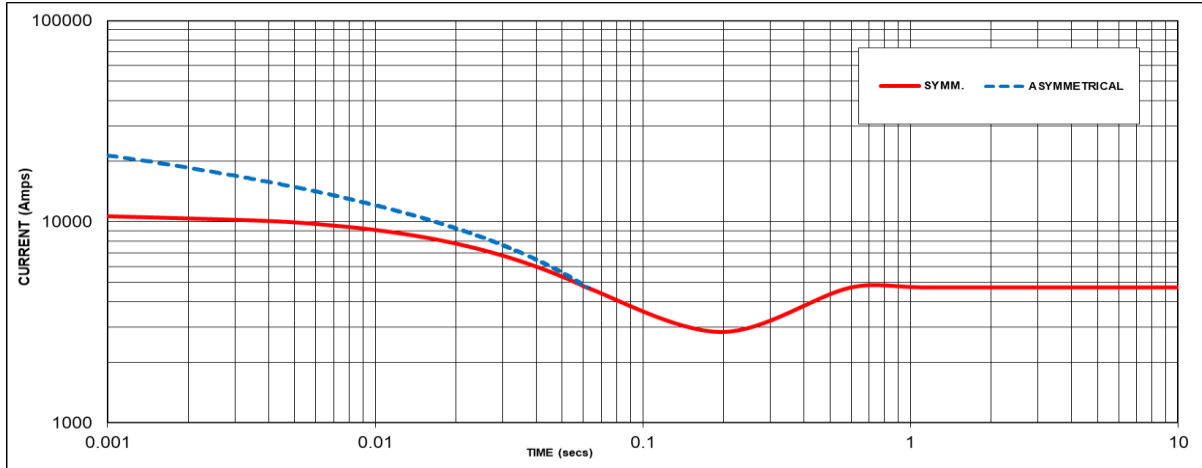

Sustained Short Circuit = 4726 Amps

Note 1

The following multiplication factors should be used to adjust the values from curve between time 0.001 seconds and the minimum current point in respect of nominal operating voltage :

50Hz		60Hz	
Voltage	Factor	Voltage	Factor
-	-	380V	X 1.00
-	-	400V	X 1.05
-	-	416V	X 1.09
-	-	-	-

The sustained current value is constant irrespective of voltage level

If MX322 or digital AVR is used, the sustained short-circuit current value is to be multiplied by a factor of 1.1.

Note 2

The following multiplication factor should be used to convert the values calculated in accordance with NOTE 1 to those applicable to the various types of short circuit :

	3-phase	2-phase L-L	1-phase L-N
Instantaneous	x 1.00	x 0.87	x 1.30
Minimum	x 1.00	x 1.80	x 3.20
Sustained	x 1.00	x 1.50	x 2.50
Max. sustained duration	10 sec.	5 sec.	2 sec.

Note 3

All other times are unchanged
 Curves are drawn for Star connections under no-load excitation at rated speeds. For other connection (where applicable) the following multipliers should be applied to current values as shown :
 Parallel Star = Curve current value X 2
 Series Delta = Curve current value X 1.732

STAMFORD

S6L1M-C4 Wdg.13/14

Typical Alternator Operating Charts

416V/60Hz

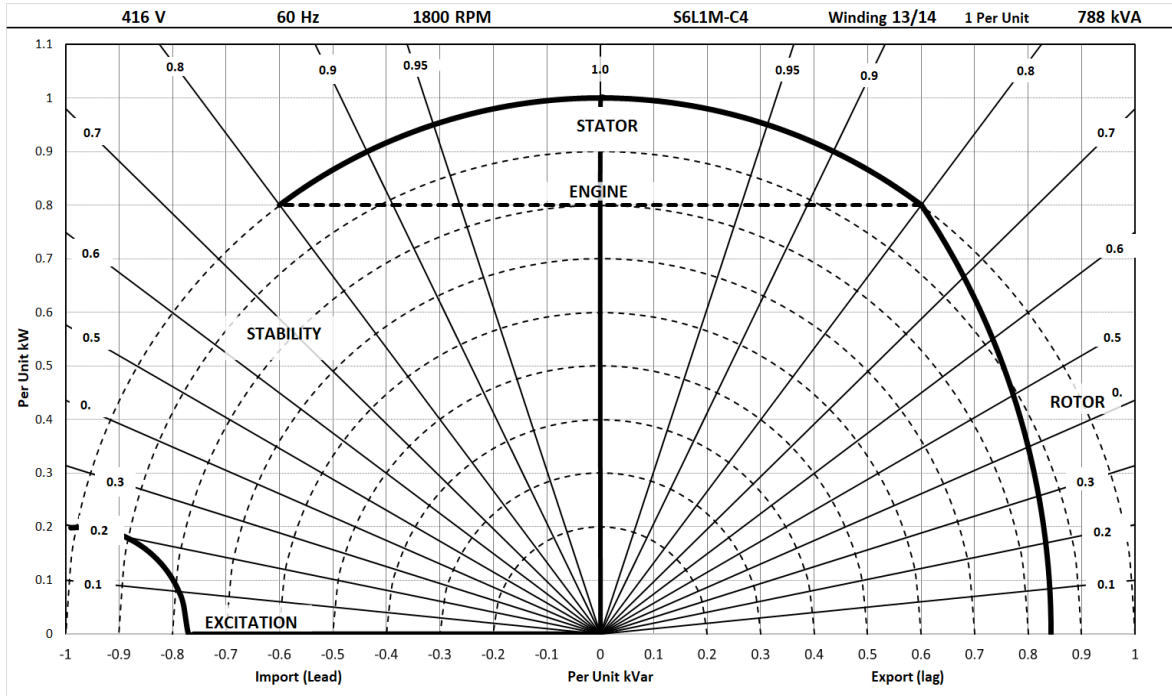

STAMFORD®

S6L1M-C4 Wdg.13/14

RATINGS AT 0.8 POWER FACTOR

Class - Temp Rise	Standby	Cont. H - 110/50°C	Cont. F - 90/50°C	Cont. B - 70/50°C
50 Hz	Star (V)	N/A	N/A	N/A
	Parallel Star (V)	N/A	N/A	N/A
	Delta (V)	N/A	N/A	N/A
	kVA	N/A	N/A	N/A
	kW	N/A	N/A	N/A
	Efficiency (%)	N/A	N/A	N/A
	kW Input	N/A	N/A	N/A

60 Hz	Star (V)	380	400	416	N/A	380	400	416	N/A	380	400	416	N/A	380	400	416	N/A
	Parallel Star (V)	190	200	208	N/A	190	200	208	N/A	190	200	208	N/A	190	200	208	N/A
	Delta (V)	220	230	240	N/A	220	230	240	N/A	220	230	240	N/A	220	230	240	N/A
	kVA	N/A	N/A	N/A	N/A	788	788	788	N/A	731	731	731	N/A	638	638	638	N/A
	kW	N/A	N/A	N/A	N/A	630	630	630	N/A	585	585	585	N/A	510	510	510	N/A
	Efficiency (%)	N/A	N/A	N/A	N/A	94.8	94.9	94.8	N/A	94.9	94.9	94.8	N/A	94.8	94.8	94.7	N/A
	kW Input	N/A	N/A	N/A	N/A	665	665	665	N/A	616	616	617	N/A	538	538	539	N/A

* Parallel Star connection only available with 12 leads winding option

De-rates

All values tabulated above are subject to the following reductions:

- 5% when air inlet filters are fitted
- 3% for every 500 meters by which the operating altitude exceeds 1000 meters above mean sea level
- 3% for every 5°C by which the operational ambient temperature exceeds 40°C @ Class H temperature rise (please refer to applications for ambient temperature de-rates at other temperature rise classes)
- For any other operating conditions impacting the cooling circuit please refer to applications

Note: Requirement for operating in an ambient exceeding 60°C and altitude exceeding 4000 meters (for <690V) or 1500 meters (for >690V) must be referred to applications.

Dimensional and Torsional Drawing

For dimensional and torsional information please refer to the alternator General Arrangement and rotor drawings available on our website (<http://stamford-avk.com/>)

Note: Continuous development of our products means that the information contained in our data sheets can change without notice, and specifications should always be confirmed with Cummins Generator Technologies prior to purchase.



Follow us @stamfordavk



Cummins Generator Technologies



View our videos at youtube.com/stamfordavk

stamford-avk.com

**For Applications Support:
applications@cummins.com**

**For Customer Service:
emea.service@cummins.com**

**For General Enquiries:
Stamford-avk@cummins.com**

Copyright 2020. Cummins Generator Technologies Ltd. All rights reserved.
Cummins and the Cummins logo are registered trade marks of Cummins Inc.
STAMFORD is a registered trade mark of Cummins Generator Technologies Ltd.

