

STAMFORD[®]

UCM224C - Winding 311

Technical  Data Sheet

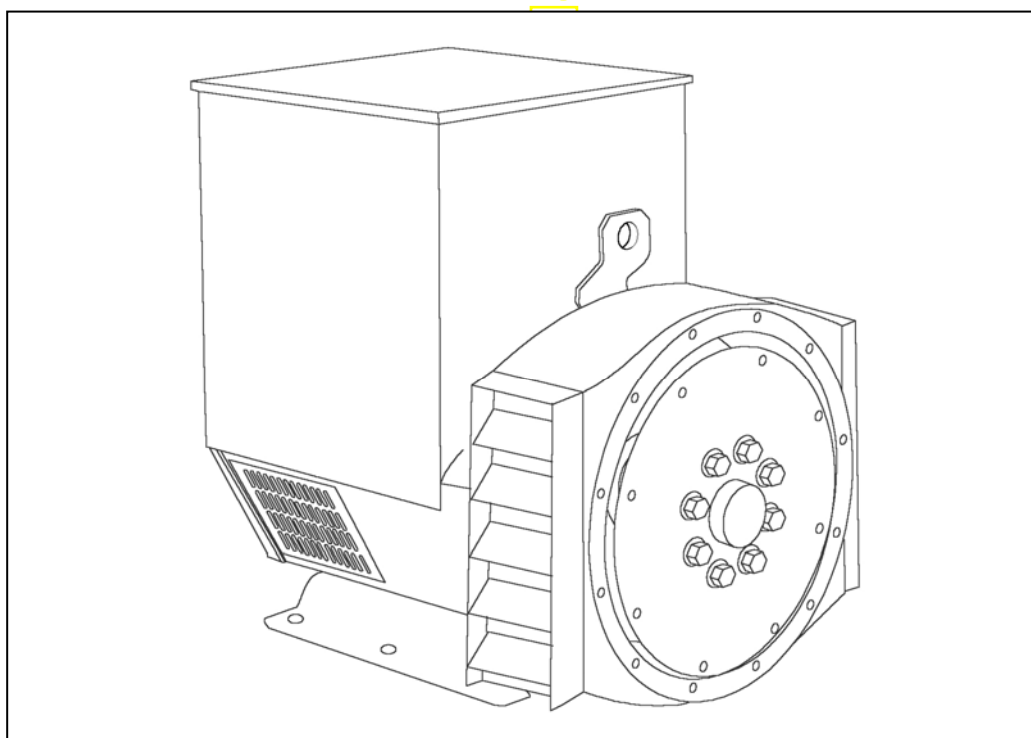

UCM224C

SPECIFICATIONS & OPTIONS

STAMFORD

STANDARDS

Marine generators may be certified to Lloyds, DnV, Bureau Veritas, ABS, Germanischer-Lloyd or RINA.

Other standards and certifications can be considered on request.

VOLTAGE REGULATORS

MX341 AVR - STANDARD

This sophisticated Automatic Voltage Regulator (AVR) is incorporated into the Stamford Permanent Magnet Generator (PMG) control system, and is standard on marine generators of this type.

The PMG provides power via the AVR to the main exciter, giving a source of constant excitation power independent of generator output. The main exciter output is then fed to the main rotor, through a full wave bridge, protected by a surge suppressor. The AVR has in-built protection against sustained over-excitation, caused by internal or external faults. This de-excites the machine after a minimum of 5 seconds.

An engine relief load acceptance feature can enable full load to be applied to the generator in a single step.

If three-phase sensing is required with the PMG system the MX321 AVR must be used.

We recommend three-phase sensing for applications with greatly unbalanced or highly non-linear loads.

MX321 AVR

The most sophisticated of all our AVRs combines all the features of the MX341 with, additionally, three-phase rms sensing, for improved regulation and performance.

Over voltage protection is built-in and short circuit current level adjustments is an optional facility.

WINDINGS & ELECTRICAL PERFORMANCE

All generator stators are wound to 2/3 pitch. This eliminates triplen (3rd, 9th, 15th ...) harmonics on the voltage waveform and is found to be the optimum design for trouble-free supply of non-linear loads. The 2/3 pitch design avoids excessive neutral currents sometimes seen with higher winding pitches, when in parallel with the mains. A fully connected damper winding reduces oscillations during paralleling. This winding, with the 2/3 pitch and carefully selected pole and tooth designs, ensures very low waveform distortion.

TERMINALS & TERMINAL BOX

Standard generators are 3-phase reconnectable with 12 ends brought out to the terminals, which are mounted on a cover at the non-drive end of the generator. A sheet steel terminal box contains the AVR and provides ample space for the customers' wiring and gland arrangements. It has removable panels for easy access.

SHAFT & KEYS

All generator rotors are dynamically balanced to better than BS6861:Part 1 Grade 2.5 for minimum vibration in operation. Two bearing generators are balanced with a half key.

INSULATION/IMPREGNATION

The insulation system is class 'H'.

All wound components are impregnated with materials and processes designed specifically to provide the high build required for static windings and the high mechanical strength required for rotating components.

QUALITY ASSURANCE

Generators are manufactured using production procedures having a quality assurance level to BS EN ISO 9001.

The stated voltage regulation may not be maintained in the presence of certain radio transmitted signals. Any change in performance will fall within the limits of Criteria 'B' of EN 61000-6-2:2001. At no time will the steady-state voltage regulation exceed 2%.

DE RATES

All values tabulated on page 8 are subject to the following reductions

5% when air inlet filters are fitted.

3% for every 500 metres by which the operating altitude exceeds 1000 metres above mean sea level.

3% for every 5°C by which the operational ambient temperature exceeds 50°C.

Note: Requirement for operating in an ambient exceeding 60°C must be referred to the factory.

NB Continuous development of our products entitles us to change specification details without notice, therefore they must not be regarded as binding.

Front cover drawing typical of product range.

APPROVED DOCUMENT

WINDING 311

| | | | |
|-------------------------|--|---------|--------------------------|
| CONTROL SYSTEM | SEPARATELY EXCITED BY P.M.G. | | |
| A.V.R. | MX321 | MX341 | |
| VOLTAGE REGULATION | ± 0.5 % | ± 1.0 % | With 4% ENGINE GOVERNING |
| SUSTAINED SHORT CIRCUIT | REFER TO SHORT CIRCUIT DECREMENT CURVES (page 7) | | |

| | | | | | | | | |
|--|--|---------|---------|---------|-----------------------------------|---------|---------|---------|
| INSULATION SYSTEM | CLASS H | | | | | | | |
| PROTECTION | IP23 | | | | | | | |
| RATED POWER FACTOR | 0.8 | | | | | | | |
| STATOR WINDING | DOUBLE LAYER CONCENTRIC | | | | | | | |
| WINDING PITCH | TWO THIRDS | | | | | | | |
| WINDING LEADS | 12 | | | | | | | |
| STATOR WDG. RESISTANCE | 0.181 Ohms PER PHASE AT 22°C SERIES STAR CONNECTED | | | | | | | |
| ROTOR WDG. RESISTANCE | 0.59 Ohms at 22°C | | | | | | | |
| EXCITER STATOR RESISTANCE | 21 Ohms at 22°C | | | | | | | |
| EXCITER ROTOR RESISTANCE | 0.071 Ohms PER PHASE AT 22°C | | | | | | | |
| R.F.I. SUPPRESSION | BS EN 61000-6-2 & BS EN 61000-6-4, VDE 0875G, VDE 0875N. refer to factory for others | | | | | | | |
| WAVEFORM DISTORTION | NO LOAD < 1.5% NON-DISTORTING BALANCED LINEAR LOAD < 5.0% | | | | | | | |
| MAXIMUM OVERSPEED | 2250 Rev/Min | | | | | | | |
| BEARING DRIVE END | BALL. 6312-2RS (ISO) | | | | | | | |
| BEARING NON-DRIVE END | BALL. 6309-2RS (ISO) | | | | | | | |
| | 1 BEARING | | | | 2 BEARING | | | |
| WEIGHT COMP. GENERATOR | 271 kg | | | | 280 kg | | | |
| WEIGHT WOUND STATOR | 75 kg | | | | 75 kg | | | |
| WEIGHT WOUND ROTOR | 78.95 kg | | | | 70.58 kg | | | |
| WR ² INERTIA | 0.3987 kgm ² | | | | 0.3667 kgm ² | | | |
| SHIPPING WEIGHTS in a crate | 294 kg | | | | 301 kg | | | |
| PACKING CRATE SIZE | 92 x 57 x 96(cm) | | | | 92 x 57 x 96(cm) | | | |
| | 50 Hz | | | | 60 Hz | | | |
| TELEPHONE INTERFERENCE | THF<2% | | | | TIF<50 | | | |
| COOLING AIR | 0.216 m ³ /sec 458 cfm | | | | 0.281 m ³ /sec 595 cfm | | | |
| VOLTAGE SERIES STAR | 380/220 | 400/231 | 415/240 | 440/254 | 416/240 | 440/254 | 460/266 | 480/277 |
| VOLTAGE PARALLEL STAR | 190/110 | 200/115 | 208/120 | 220/127 | 208/120 | 220/127 | 230/133 | 240/138 |
| VOLTAGE SERIES DELTA | 220/110 | 230/115 | 240/120 | 254/127 | 240/120 | 254/127 | 266/133 | 277/138 |
| KVA BASE RATING FOR REACTANCE VALUES | 38 | 38 | 38 | 26.8 | 43.8 | 44.7 | 44.7 | 46.5 |
| X _d DIR. AXIS SYNCHRONOUS | 2.16 | 1.96 | 1.82 | 1.14 | 2.65 | 2.42 | 2.21 | 2.11 |
| X' _d DIR. AXIS TRANSIENT | 0.17 | 0.15 | 0.14 | 0.09 | 0.19 | 0.18 | 0.16 | 0.15 |
| X'' _d DIR. AXIS SUBTRANSIENT | 0.11 | 0.10 | 0.09 | 0.06 | 0.13 | 0.12 | 0.11 | 0.10 |
| X _q QUAD. AXIS REACTANCE | 1.00 | 0.90 | 0.84 | 0.53 | 1.23 | 1.12 | 1.02 | 0.98 |
| X'' _q QUAD. AXIS SUBTRANSIENT | 0.14 | 0.13 | 0.12 | 0.07 | 0.12 | 0.11 | 0.10 | 0.10 |
| X _L LEAKAGE REACTANCE | 0.07 | 0.07 | 0.06 | 0.04 | 0.09 | 0.08 | 0.08 | 0.07 |
| X ₂ NEGATIVE SEQUENCE | 0.13 | 0.12 | 0.11 | 0.07 | 0.12 | 0.11 | 0.10 | 0.10 |
| X ₀ ZERO SEQUENCE | 0.09 | 0.08 | 0.07 | 0.04 | 0.09 | 0.08 | 0.08 | 0.07 |
| REACTANCES ARE SATURATED VALUES ARE PER UNIT AT RATING AND VOLTAGE INDICATED | | | | | | | | |
| T' _d TRANSIENT TIME CONST. | 0.025 s | | | | | | | |
| T'' _d SUB-TRANSTIME CONST. | 0.006 s | | | | | | | |
| T' _{do} O.C. FIELD TIME CONST. | 0.65 s | | | | | | | |
| T _a ARMATURE TIME CONST. | 0.005 s | | | | | | | |
| SHORT CIRCUIT RATIO | 1/X _d | | | | | | | |

50
Hz

UCM224C
Winding 311

STAMFORD

THREE PHASE EFFICIENCY CURVES

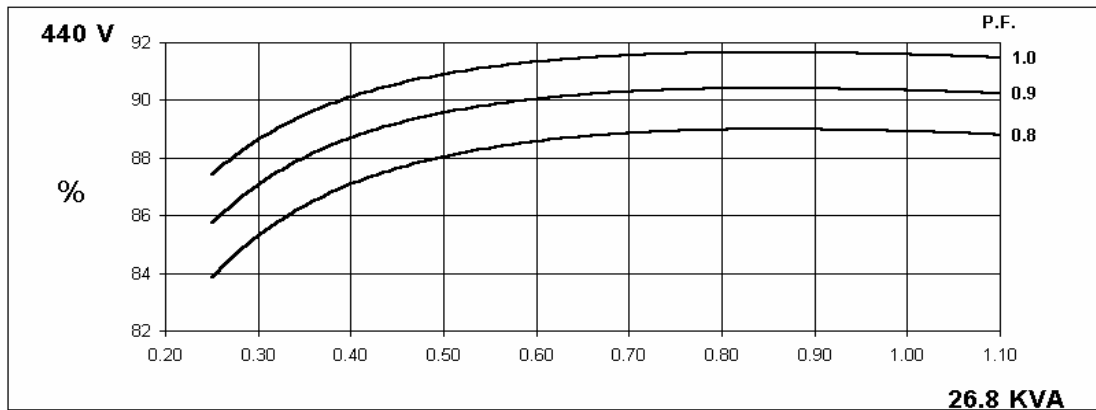
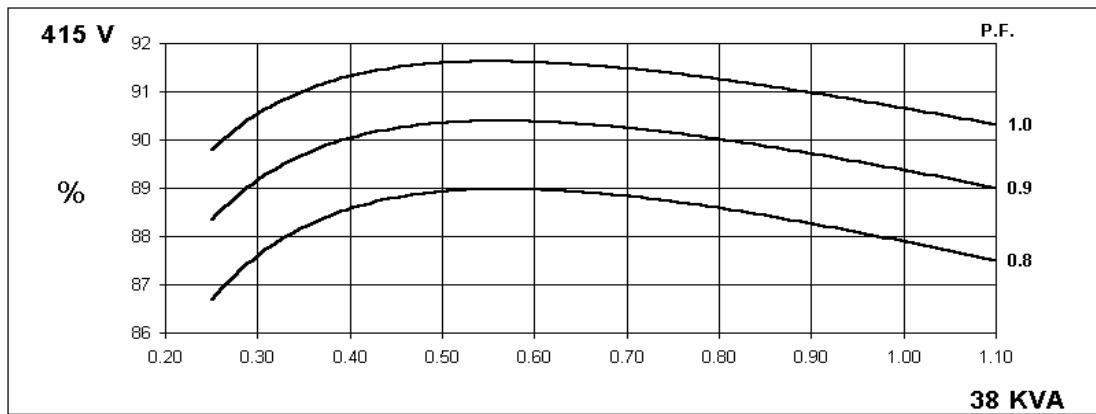
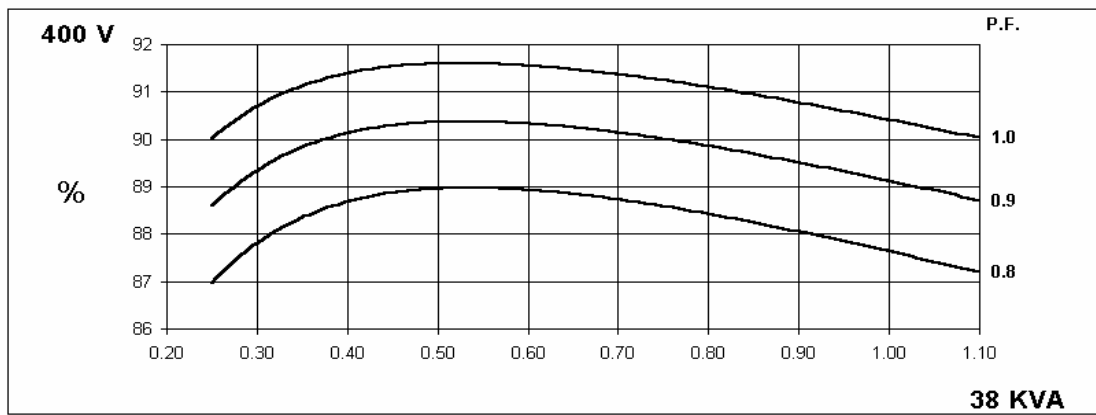
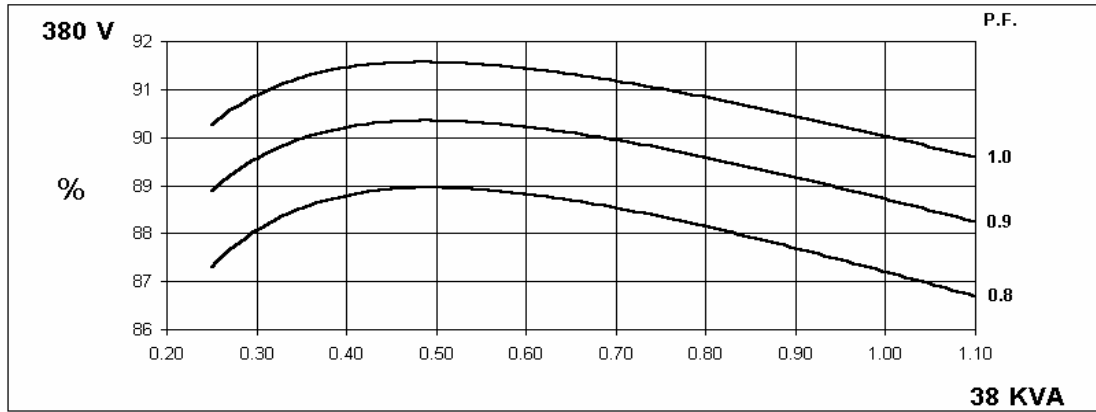

60
Hz

UCM224C
Winding 311

STAMFORD

THREE PHASE EFFICIENCY CURVES

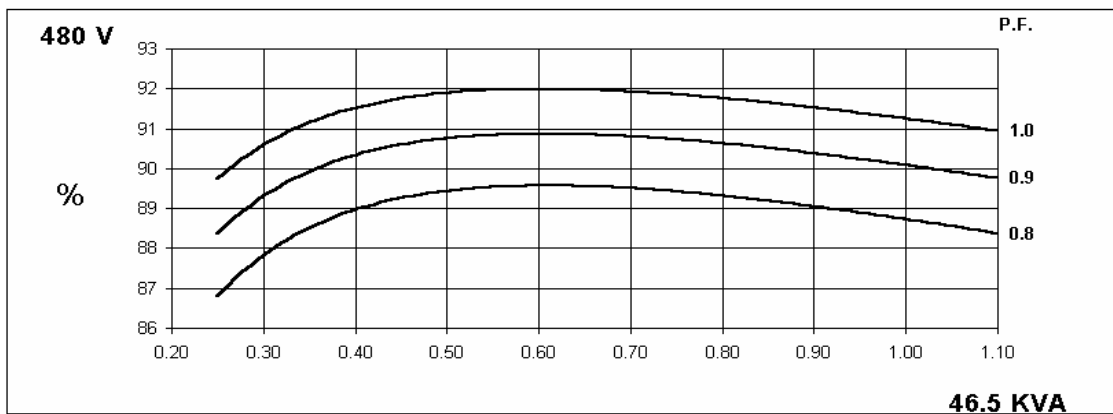
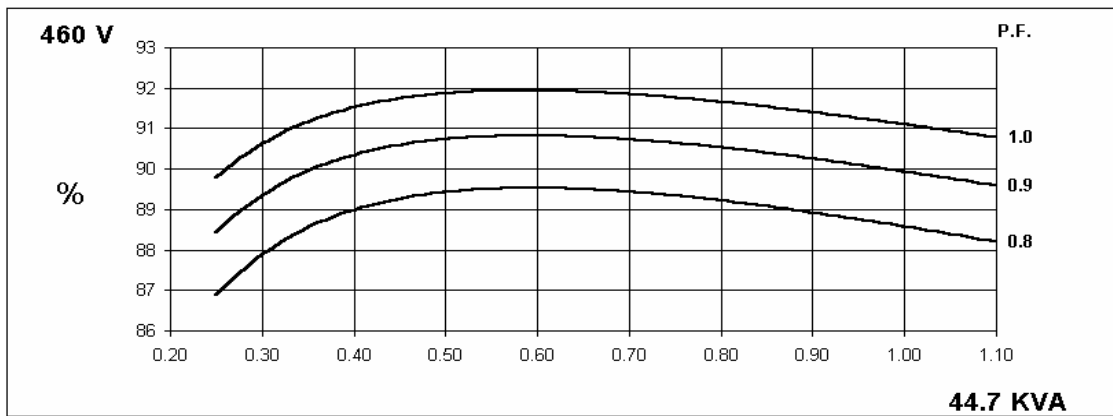
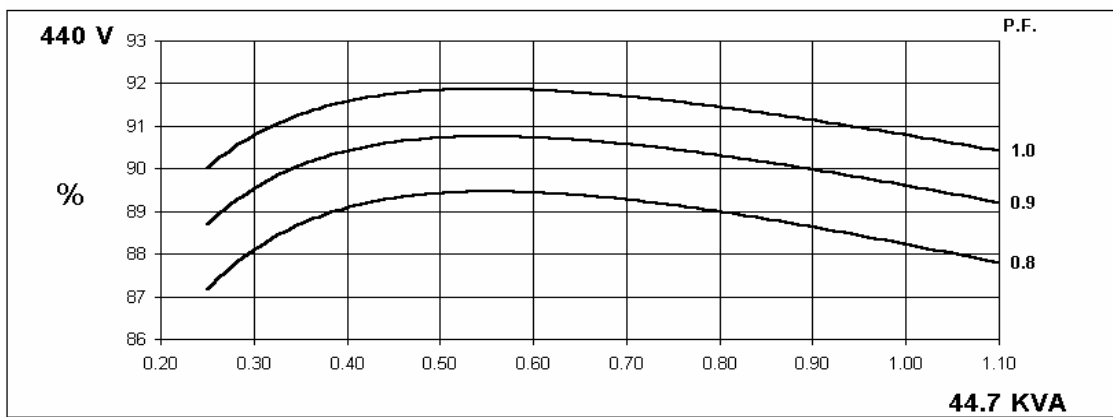
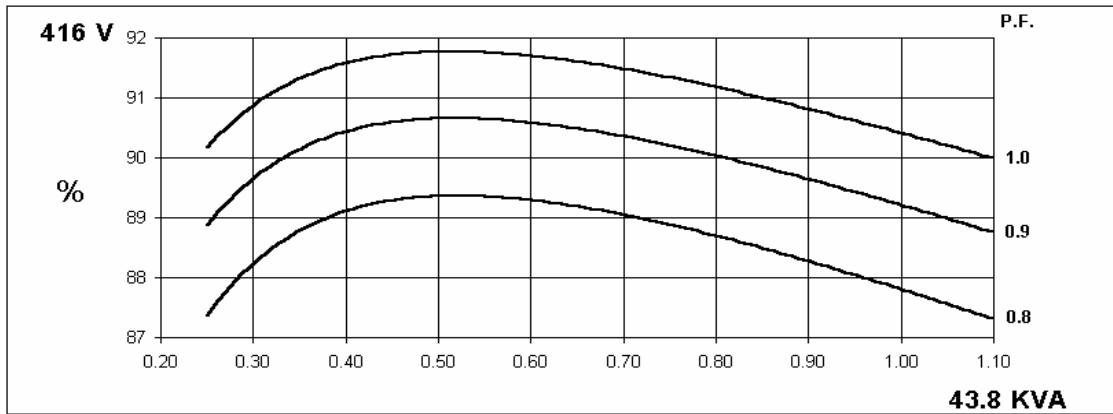

Locked Rotor Motor Starting Curve

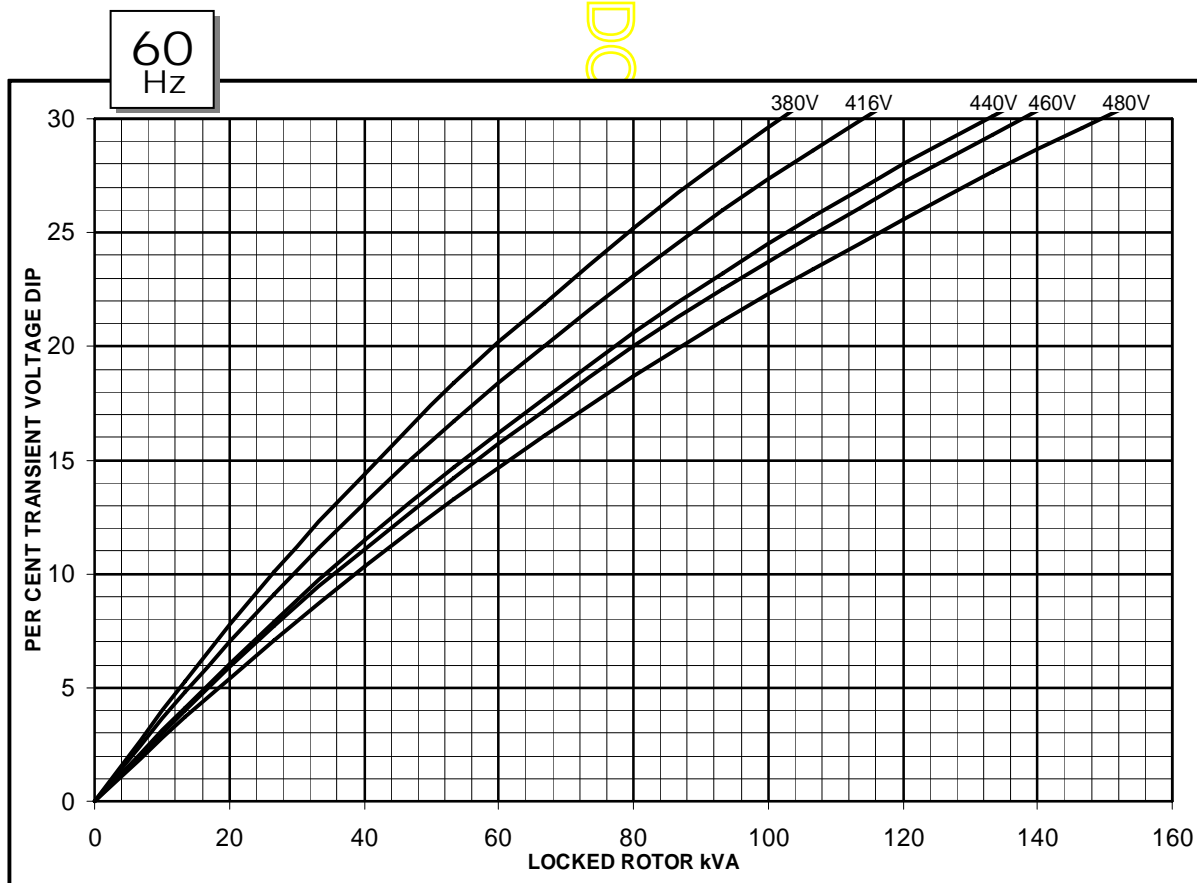
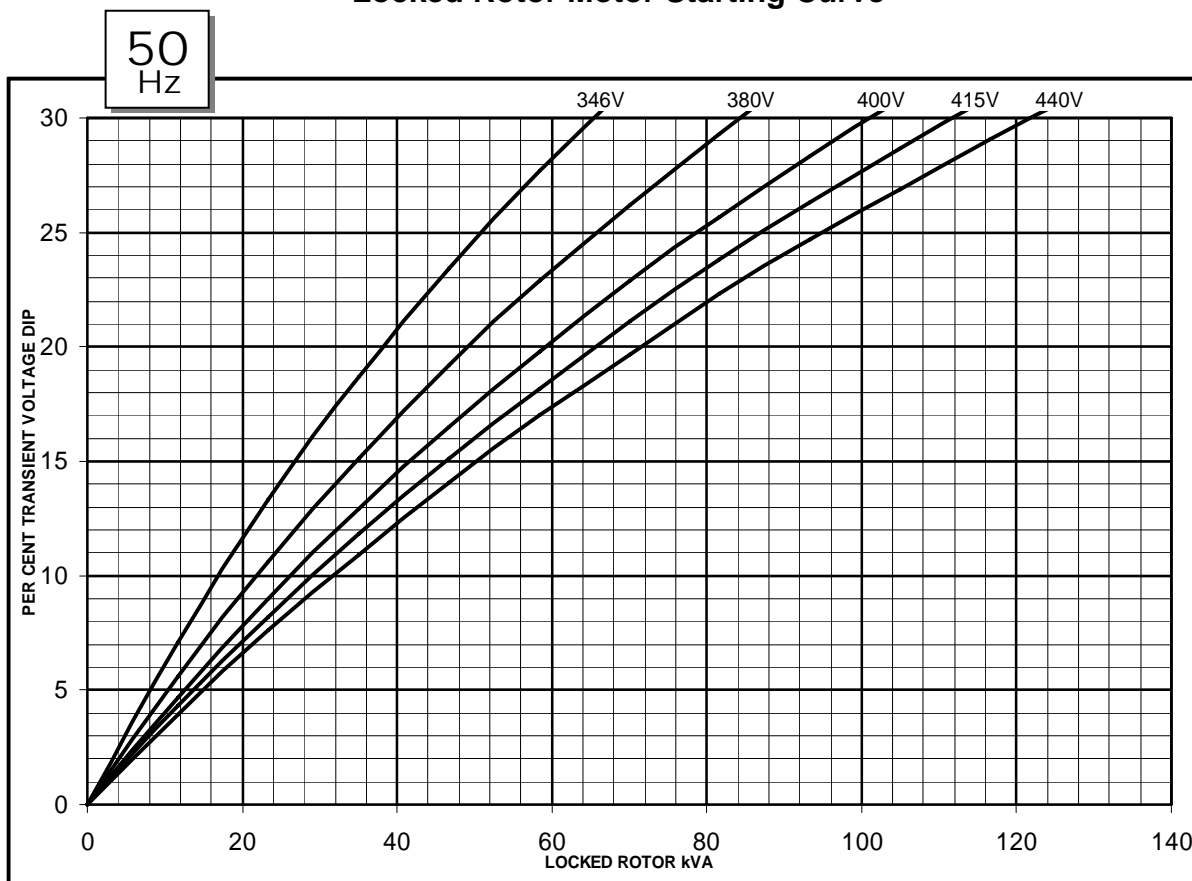

**Three-phase Short Circuit Decrement Curve. No-load Excitation at Rated Speed
Based on star (wye) connection.**

50
Hz

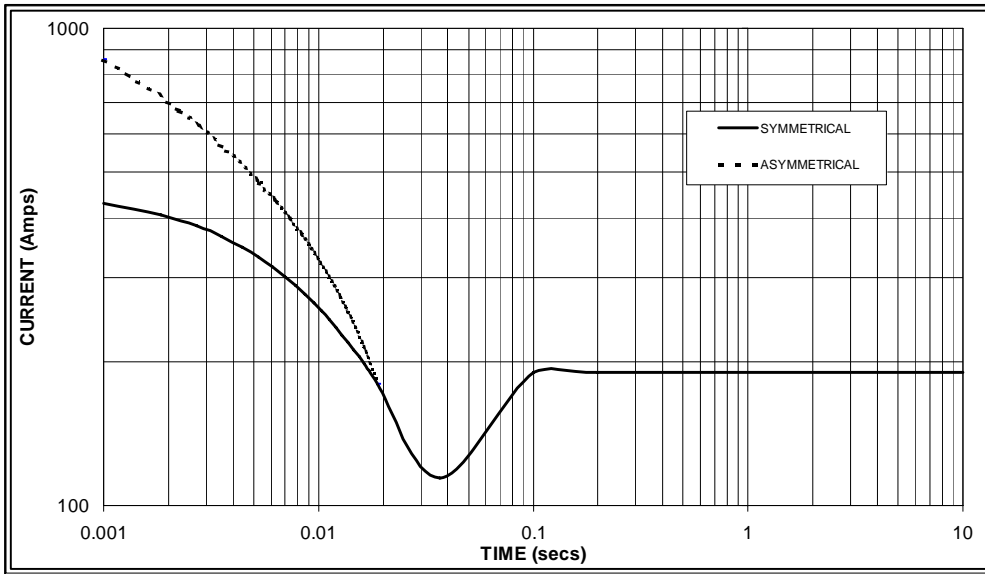

Sustained Short Circuit = 190 Amps



60
Hz

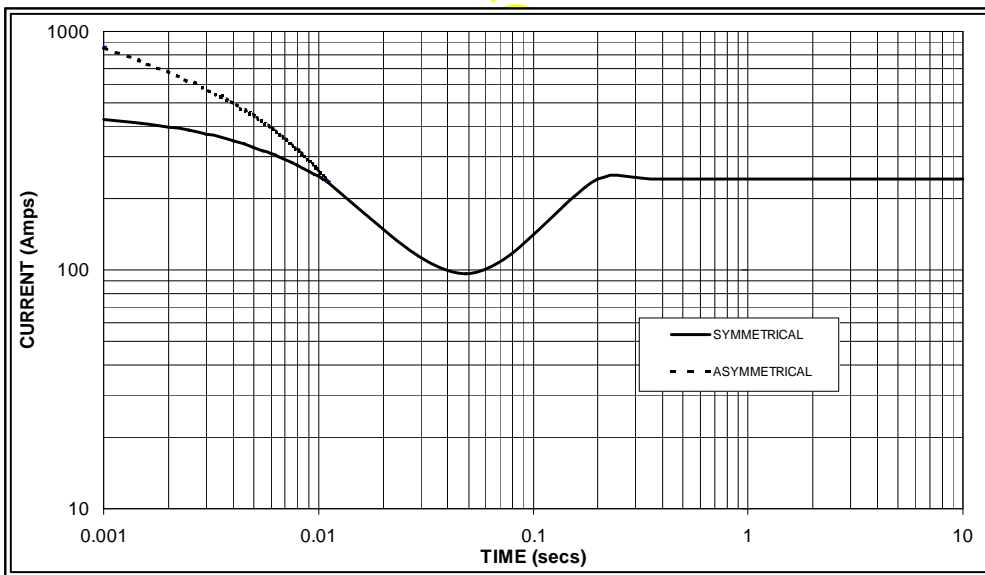

Sustained Short Circuit = 240 Amps

Note 1

The following multiplication factors should be used to adjust the values from curve between time 0.001 seconds and the minimum current point in respect of nominal operating voltage :

| 50Hz | | 60Hz | |
|---------|--------|---------|--------|
| Voltage | Factor | Voltage | Factor |
| 380v | X 1.00 | 416v | X 1.00 |
| 400v | X 1.07 | 440v | X 1.06 |
| 415v | X 1.12 | 460v | X 1.12 |
| 440v | X 1.18 | 480v | X 1.17 |

The sustained current value is constant irrespective of voltage level

Note 2

The following multiplication factor should be used to convert the values calculated in accordance with NOTE 1 to those applicable to the various types of short circuit :

| | 3-phase | 2-phase L-L | 1-phase L-N |
|-------------------------|---------|-------------|-------------|
| Instantaneous | x 1.00 | x 0.87 | x 1.30 |
| Minimum | x 1.00 | x 1.80 | x 3.20 |
| Sustained | x 1.00 | x 1.50 | x 2.50 |
| Max. sustained duration | 10 sec. | 5 sec. | 2 sec. |

All other times are unchanged

Note 3

Curves are drawn for Star (Wye) connected machines. For other connection the following multipliers should be applied to current values as shown :

Parallel Star = Curve current value X 2

Series Delta = Curve current value X 1.732

UCM224C
Winding 311 / 0.8 Power Factor

RATINGS

| Class - Temp Rise | Cont. E - 65/50°C | | | | Cont. B - 70/50°C | | | | Cont. F - 90/50°C | | | | Cont. H - 110/50°C | | | | |
|-------------------|-------------------|------|------|------|-------------------|------|------|------|-------------------|------|------|------|--------------------|------|------|------|-----|
| 50 Hz | Series Star (V) | 380 | 400 | 415 | 440 | 380 | 400 | 415 | 440 | 380 | 400 | 415 | 440 | 380 | 400 | 415 | 440 |
| | Parallel Star (V) | 190 | 200 | 208 | 220 | 190 | 200 | 208 | 220 | 190 | 200 | 208 | 220 | 190 | 200 | 208 | 220 |
| | Series Delta (V) | 220 | 230 | 240 | 254 | 220 | 230 | 240 | 254 | 220 | 230 | 240 | 254 | 220 | 230 | 240 | 254 |
| kVA | 29.4 | 29.4 | 29.4 | 21.4 | 31.0 | 31.0 | 31.0 | 22.5 | 35.0 | 35.0 | 35.0 | 25.5 | 38.0 | 38.0 | 38.0 | 26.8 | |
| kW | 23.5 | 23.5 | 23.5 | 17.1 | 24.8 | 24.8 | 24.8 | 18.0 | 28.0 | 28.0 | 28.0 | 20.4 | 30.4 | 30.4 | 30.4 | 21.4 | |
| Efficiency (%) | 88.2 | 88.5 | 88.7 | 88.9 | 88.1 | 88.4 | 88.5 | 89.0 | 87.6 | 88.0 | 88.2 | 89.0 | 87.2 | 87.6 | 87.9 | 88.9 | |
| kW Input | 26.7 | 26.6 | 26.5 | 19.2 | 28.1 | 28.1 | 28.0 | 20.2 | 32.0 | 31.8 | 31.7 | 22.9 | 34.9 | 34.7 | 34.6 | 24.1 | |

| | | | | | | | | | | | | | | | | | |
|----------------|-------------------|------|------|------|------|------|------|------|------|------|------|------|------|------|------|------|-----|
| 60 Hz | Series Star (V) | 416 | 440 | 460 | 480 | 416 | 440 | 460 | 480 | 416 | 440 | 460 | 480 | 416 | 440 | 460 | 480 |
| | Parallel Star (V) | 208 | 220 | 230 | 240 | 208 | 220 | 230 | 240 | 208 | 220 | 230 | 240 | 208 | 220 | 230 | 240 |
| | Series Delta (V) | 240 | 254 | 266 | 277 | 240 | 254 | 266 | 277 | 240 | 254 | 266 | 277 | 240 | 254 | 266 | 277 |
| kVA | 33.0 | 35.0 | 36.0 | 36.0 | 35.0 | 36.3 | 37.5 | 37.5 | 39.4 | 41.9 | 43.1 | 43.1 | 43.8 | 44.7 | 44.7 | 46.5 | |
| kW | 26.4 | 28.0 | 28.8 | 28.8 | 28.0 | 29.0 | 30.0 | 30.0 | 31.5 | 33.5 | 34.5 | 34.5 | 35.0 | 35.8 | 35.8 | 37.2 | |
| Efficiency (%) | 88.9 | 89.0 | 89.2 | 89.4 | 88.7 | 88.9 | 89.1 | 89.3 | 88.3 | 88.5 | 88.7 | 89.0 | 87.8 | 88.2 | 88.6 | 88.7 | |
| kW Input | 29.7 | 31.5 | 32.3 | 32.2 | 31.6 | 32.7 | 33.7 | 33.6 | 35.7 | 37.9 | 38.9 | 38.7 | 39.9 | 40.5 | 40.4 | 41.9 | |

DIMENSIONS

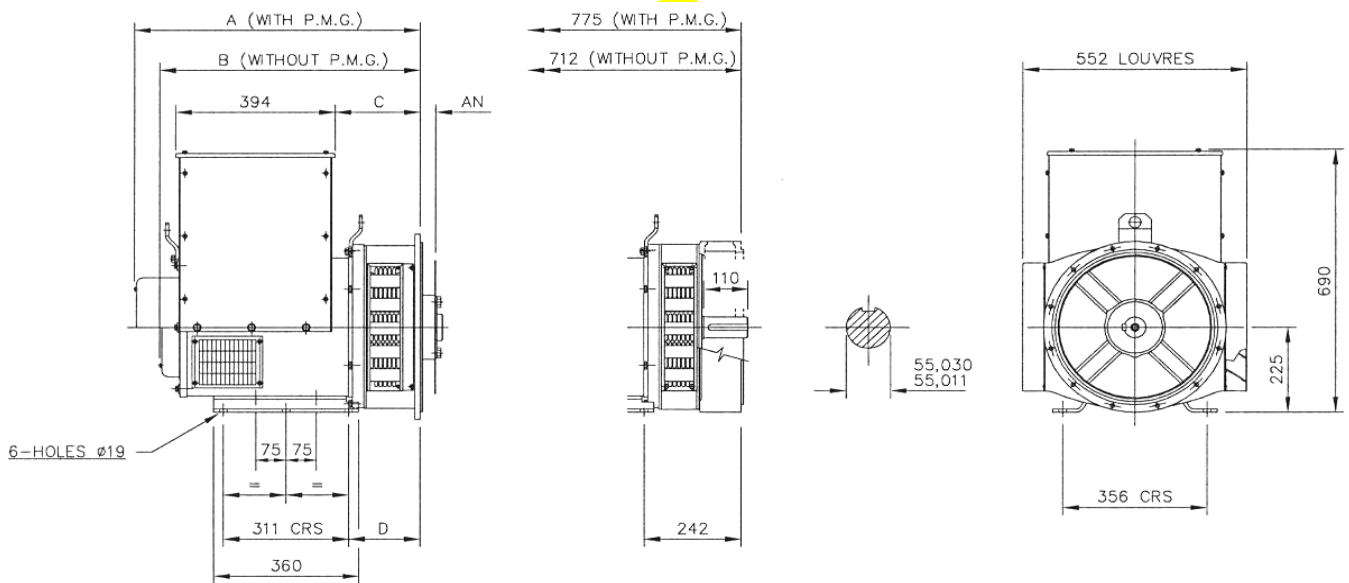

| SINGLE BEARING ADAPTORS | | | | |
|-------------------------|-------|-------|-------|-------|
| ADAPTOR | A | B | C | D |
| SAE 1 | 724,3 | 661,3 | 224,3 | 191,3 |
| SAE 2 | 710 | 647 | 210 | 177 |
| SAE 3 | 710 | 647 | 210 | 177 |
| SAE 4 | 710 | 647 | 210 | 177 |

| COUPLING DISCS | |
|----------------|-------|
| DISC | AN |
| SAE 8 | 61,90 |
| SAE 10 | 53,98 |
| SAE 11,5 | 39,68 |
| SAE 14 | 25,40 |

APPROVED DOCUMENT

STAMFORD

Head Office Address:
Barnack Road, Stamford
Lincolnshire, PE9 2NB
United Kingdom
Tel: +44 (0) 1780 484000
Fax: +44 (0) 1780 484100

www.cumminsgeneratortechnologies.com

Copyright 2010, Cummins Generator Technologies Ltd, All Rights Reserved
Stamford and AvK are registered trade marks of Cummins Generator Technologies Ltd
Cummins and the Cummins logo are registered trade marks of Cummins Inc.