

Document Generated: 24MAR2021 12:41 GMT

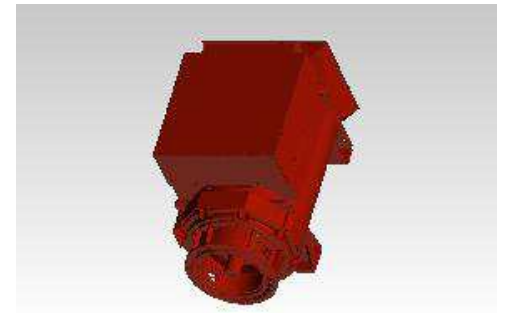

Part Number: A066T396

Change Notice	CN00031350	Alternates	
Manufacturer Part (MEP)	No	Usage	Production and Service
Release Phase Code	Production (P)	Drawing Specification	DS47069619
External Regulations	No External Regulation		



3D image provided when available for visual reference only.

Associated Specifications

Number	Name	Type	Category	Sub-Category
ESA030B356	SPECIFICATION,MATERIAL	Engineering Specification	Material Specification	Prohibited and Restricted Prohibited and Restricted

Drawing Revision Information

Description of Change(s)
PRODUCTION RELEASE.

Drawing Authorization

Drafter	Mihai-Cristian Ilinca	Date	24MAR2021
Checker	Daniel Ciochina	Date	24MAR2021
Approver	NO APPROVAL REQUIRED	Date	

Document Generated: 24MAR2021 12:41 GMT