

STAMFORD[®]

HCM534E - Winding 311 Single Phase

Technical Data Sheet

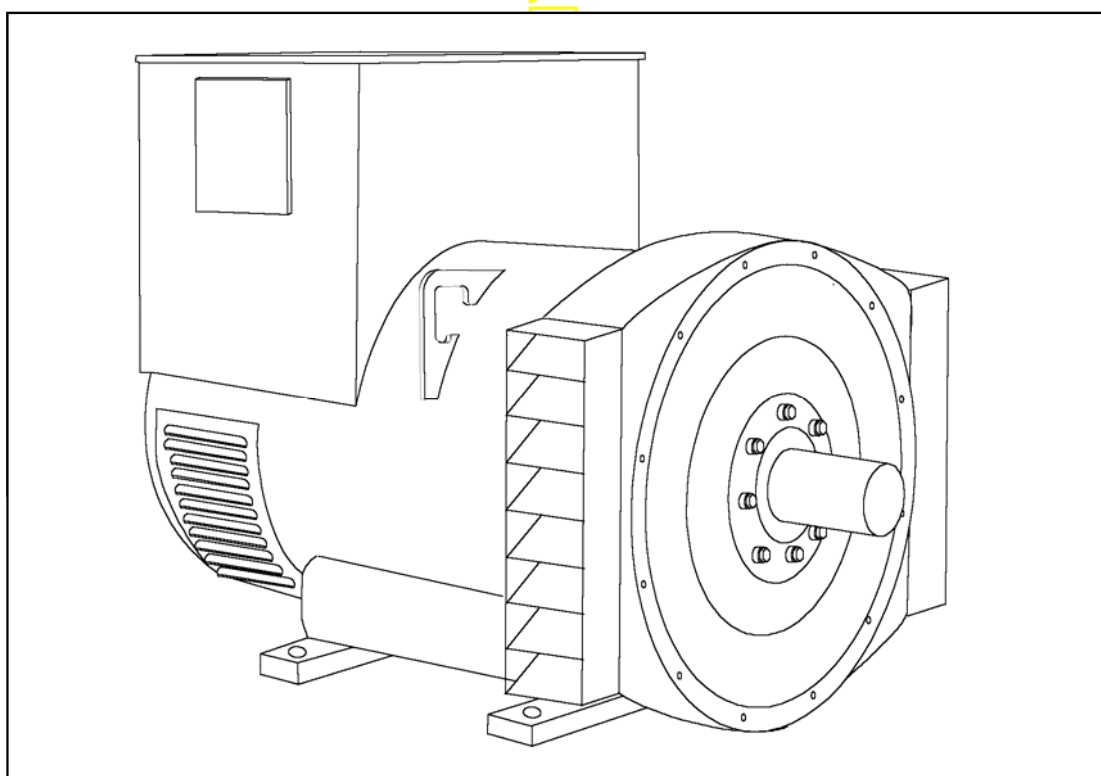

HCM534E

SPECIFICATIONS & OPTIONS

STAMFORD

STANDARDS

Marine generators may be certified to Lloyds, DnV, Bureau Veritas, ABS, Germanischer-Lloyd or RINA. Other standards and certifications can be considered on request.

VOLTAGE REGULATORS

MX341 AVR - STANDARD

This sophisticated Automatic Voltage Regulator (AVR) is incorporated into the Stamford Permanent Magnet Generator (PMG) control system, and is standard on marine generators of this type.

The PMG provides power via the AVR to the main exciter, giving a source of constant excitation power independent of generator output. The main exciter output is then fed to the main rotor, through a full wave bridge, protected by a surge suppressor. The AVR has in-built protection against sustained over-excitation, caused by internal or external faults. This de-excites the machine after a minimum of 5 seconds.

An engine relief load acceptance feature can enable full load to be applied to the generator in a single step.

If three-phase sensing is required with the PMG system the MX321 AVR must be used.

We recommend three-phase sensing for applications with greatly unbalanced or highly non-linear loads.

MX321 AVR

The most sophisticated of all our AVRs combines all the features of the MX341 with, additionally, three-phase rms sensing, for improved regulation and performance.

Over voltage protection is built-in and short circuit current level adjustments is an optional facility.

WINDINGS & ELECTRICAL PERFORMANCE

All generator stators are wound to 2/3 pitch. This eliminates triplen (3rd, 9th, 15th ...) harmonics on the voltage waveform and is found to be the optimum design for trouble-free supply of non-linear loads. The 2/3 pitch design avoids excessive neutral currents sometimes seen with higher winding pitches, when in parallel with the mains. A fully connected damper winding reduces oscillations during paralleling. This winding, with the 2/3 pitch and carefully selected pole and tooth designs, ensures very low waveform distortion.

TERMINALS & TERMINAL BOX

Standard generators are 3-phase reconnectable with 12 ends brought out to the terminals, which are mounted on a cover at the non-drive end of the generator. A sheet steel terminal box contains the AVR and provides ample space for the customers' wiring and gland arrangements. It has removable panels for easy access.

SHAFT & KEYS

All generator rotors are dynamically balanced to better than BS6861:Part 1 Grade 2.5 for minimum vibration in operation. Two bearing generators are balanced with a half key.

INSULATION/IMPREGNATION

The insulation system is class 'H'.

All wound components are impregnated with materials and processes designed specifically to provide the high build required for static windings and the high mechanical strength required for rotating components.

QUALITY ASSURANCE

Generators are manufactured using production procedures having a quality assurance level to BS EN ISO 9001.

The stated voltage regulation may not be maintained in the presence of certain radio transmitted signals. Any change in performance will fall within the limits of Criteria 'B' of EN 61000-6-2:2001. At no time will the steady-state voltage regulation exceed 2%.

DE RATES

All values tabulated on page 8 are subject to the following reductions

5% when air inlet filters are fitted.

3% for every 500 metres by which the operating altitude exceeds 1000 metres above mean sea level.

3% for every 5 C by which the operational ambient temperature exceeds 40 C.

Note: Requirement for operating in an ambient exceeding 60 C must be referred to the factory.

NB Continuous development of our products entitles us to change specification details without notice, therefore they must not be regarded as binding.

Front cover drawing typical of product range.

APPROVED DOCUMENT

HCM534E

STAMFORD

WINDING 311 Single Phase

CONTROL SYSTEM	SEPARATELY EXCITED BY P.M.G.		
A.V.R.	MX321	MX341	
VOLTAGE REGULATION	± 0.5 %	± 1.0 %	With 4% ENGINE GOVERNING
SUSTAINED SHORT CIRCUIT	REFER TO SHORT CIRCUIT DECREMENT CURVES (page 7)		

INSULATION SYSTEM	CLASS H
PROTECTION	IP23
RATED POWER FACTOR	0.8
STATOR WINDING	DOUBLE LAYER LAP
WINDING PITCH	TWO THIRDS
WINDING LEADS	12
STATOR WDG. RESISTANCE	0.003 Ohms AT 22°C DOUBLE DELTA CONNECTED
ROTOR WDG. RESISTANCE	1.96 Ohms at 22°C
EXCITER STATOR RESISTANCE	17 Ohms at 22°C
EXCITER ROTOR RESISTANCE	0.092 Ohms PER PHASE AT 22°C
R.F.I. SUPPRESSION	BS EN 61000-6-2 & BS EN 61000-6-4, VDE 0875G, VDE 0875N. refer to factory for others
WAVEFORM DISTORTION	NO LOAD < 1.5% NON-DISTORTING BALANCED LINEAR LOAD < 5.0%
MAXIMUM OVERSPEED	2250 Rev/Min
BEARING DRIVE END	BALL. 6220 (ISO)
BEARING NON-DRIVE END	BALL. 6314 (ISO)

	1 BEARING			2 BEARING		
WEIGHT COMP. GENERATOR	1543 kg			1535 kg		
WEIGHT WOUND STATOR	722 kg			722 kg		
WEIGHT WOUND ROTOR	617 kg			588 kg		
WR ² INERTIA	8.9828 kgm ²			8.7049 kgm ²		
SHIPPING WEIGHTS in a crate	1635 kg			1625 kg		
PACKING CRATE SIZE	166 x 87 x 124(cm)			166 x 87 x 124(cm)		
	50 Hz			60 Hz		
TELEPHONE INTERFERENCE	THF<2%			TIF<50		
COOLING AIR	1.035 m ³ /sec 2202 cfm			1.312 m ³ /sec 2780 cfm		
VOLTAGE DOUBLE DELTA	220/110	230/115	240/120	220/110	230/115	240/120
VOLTAGE PARALLEL DELTA	110	115	120	110	115	120
KVA BASE RATING FOR REACTANCE VALUES	212	212	212	222	233	243
X _d DIR. AXIS SYNCHRONOUS	1.65	1.51	1.39	2.04	1.96	1.88
X' _d DIR. AXIS TRANSIENT	0.09	0.08	0.07	0.10	0.09	0.09
X'' _d DIR. AXIS SUBTRANSIENT	0.06	0.06	0.05	0.07	0.07	0.06
X _q QUAD. AXIS REACTANCE	1.29	1.18	1.08	1.63	1.57	1.50
X'' _q QUAD. AXIS SUBTRANSIENT	0.14	0.13	0.12	0.20	0.19	0.18
X _L LEAKAGE REACTANCE	0.03	0.03	0.03	0.03	0.03	0.03
X ₂ NEGATIVE SEQUENCE	0.09	0.09	0.08	0.13	0.13	0.12
X ₀ ZERO SEQUENCE	0.04	0.04	0.04	0.06	0.06	0.05

REACTANCES ARE SATURATED

VALUES ARE PER UNIT AT RATING AND VOLTAGE INDICATED

T' _d TRANSIENT TIME CONST.	0.08 s
T'' _d SUB-TRANSTIME CONST.	0.012 s
T' _{do} O.C. FIELD TIME CONST.	2.5 s
T _a ARMATURE TIME CONST.	0.019 s
SHORT CIRCUIT RATIO	1/X _d

50
Hz

HCM534E
Winding 311 Single Phase

STAMFORD

SINGLE PHASE EFFICIENCY CURVES

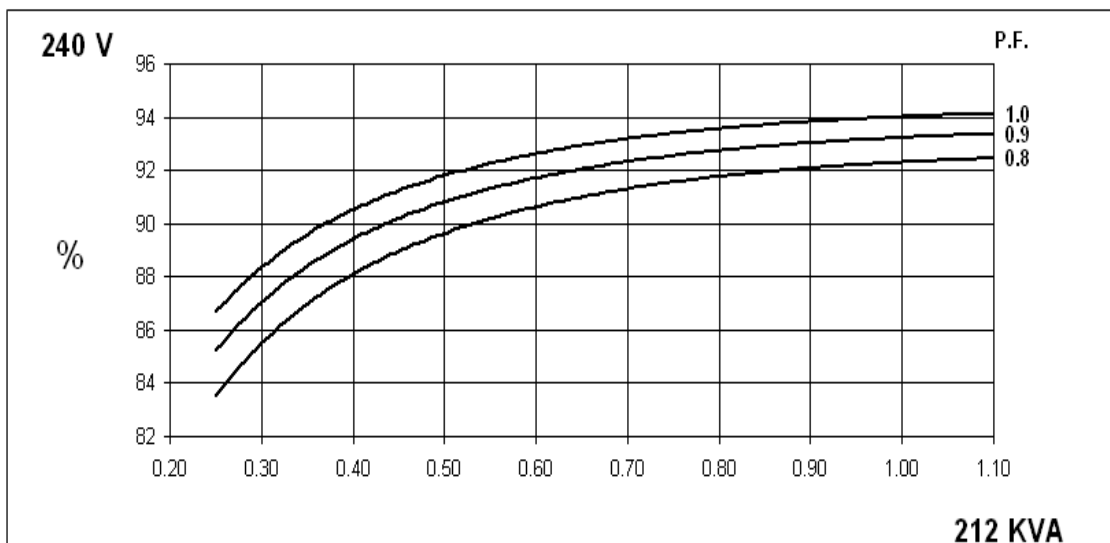
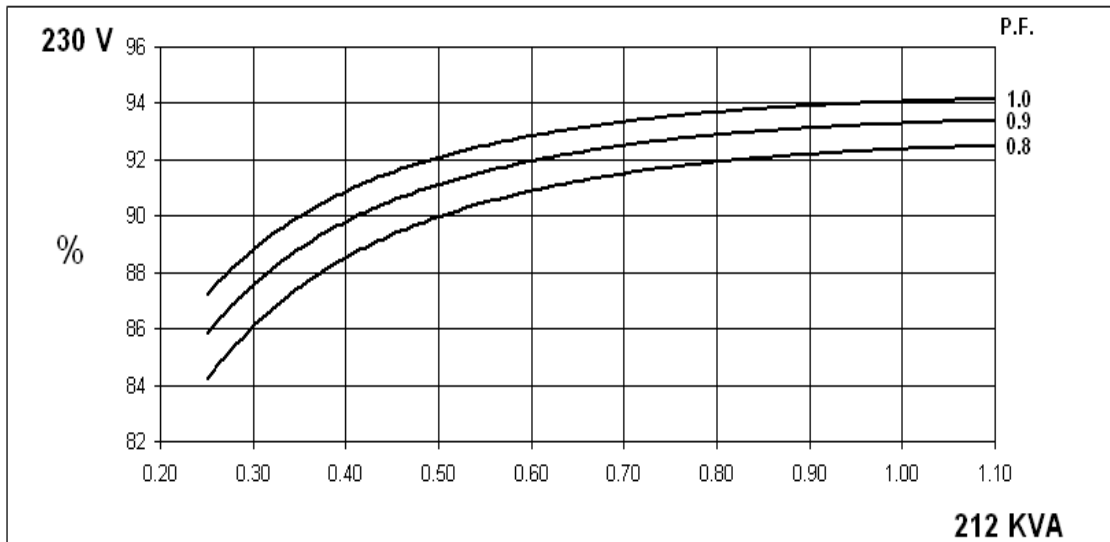
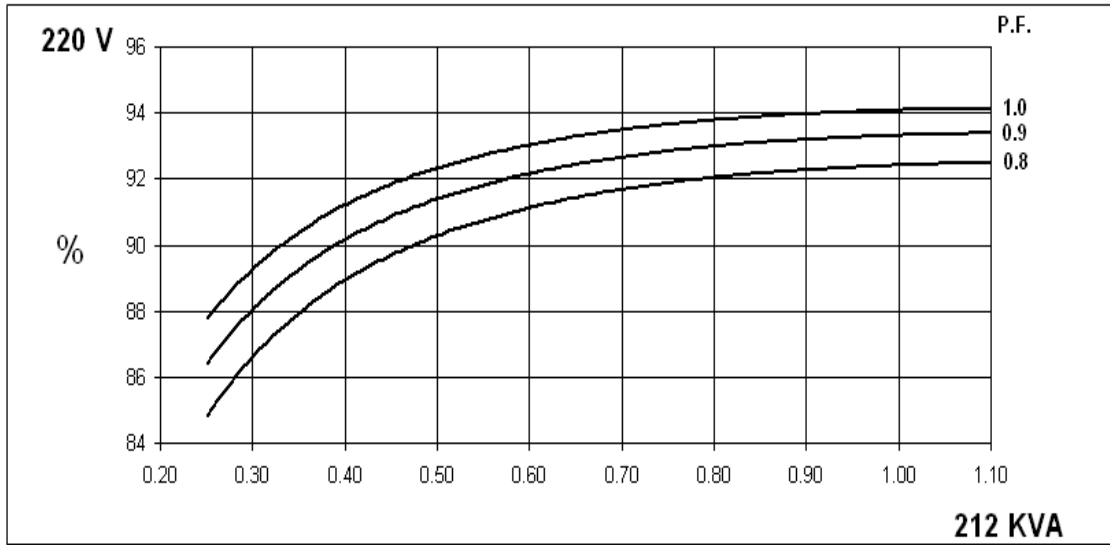

60
Hz

HCM534E
Winding 311 Single Phase

STAMFORD

SINGLE PHASE EFFICIENCY CURVES

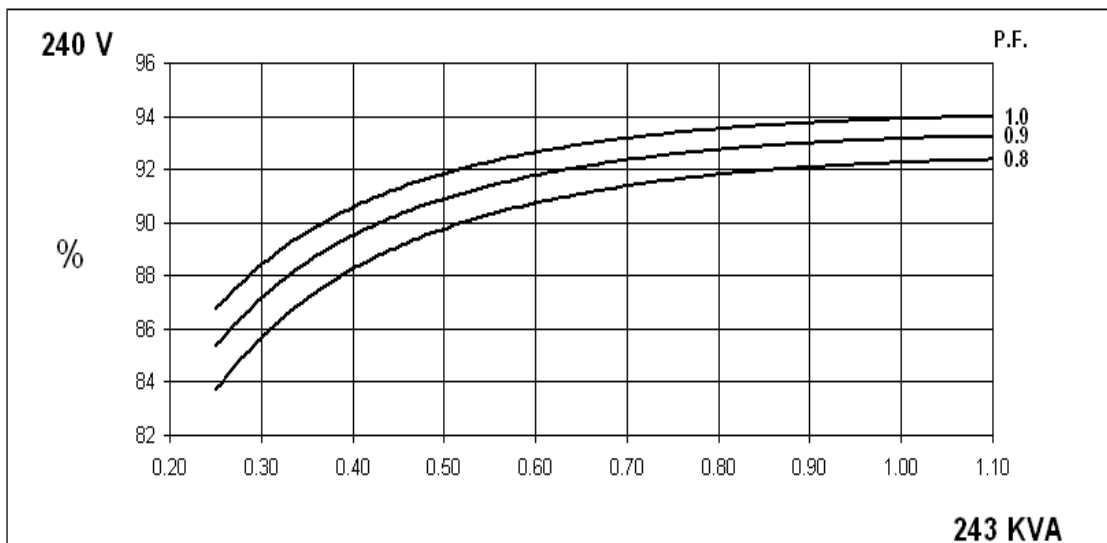
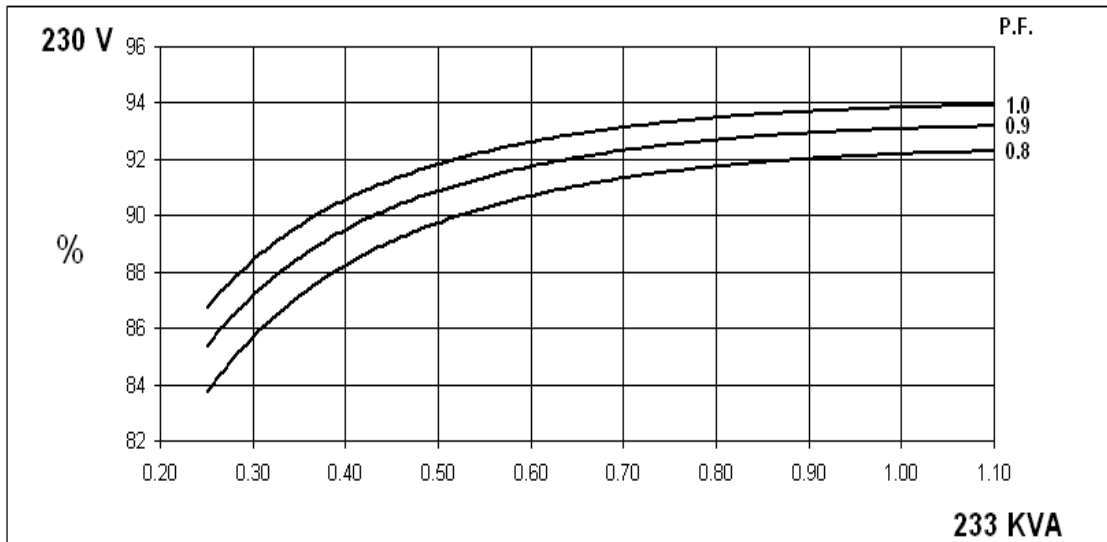
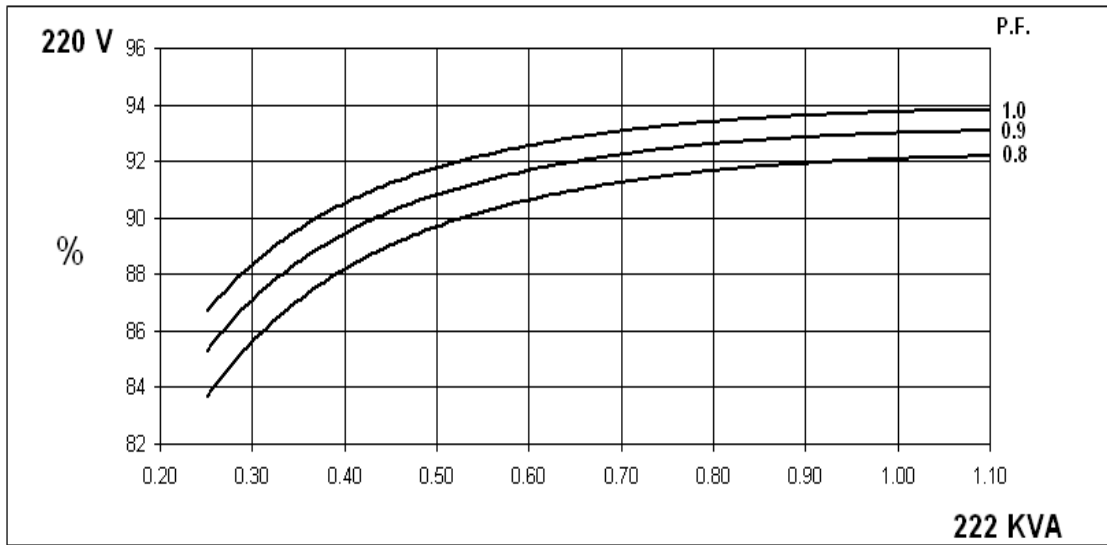

Winding 311 Single Phase

Locked Rotor Motor Starting Curve

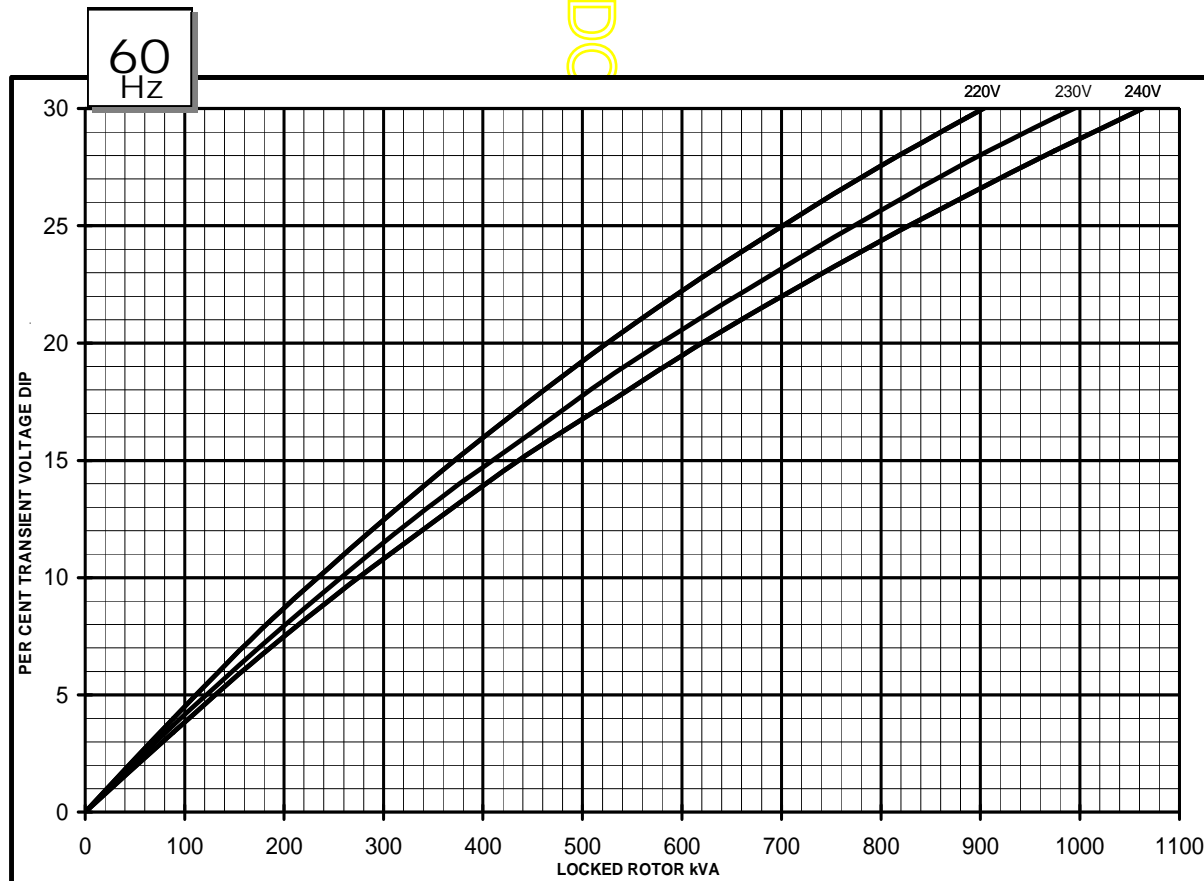
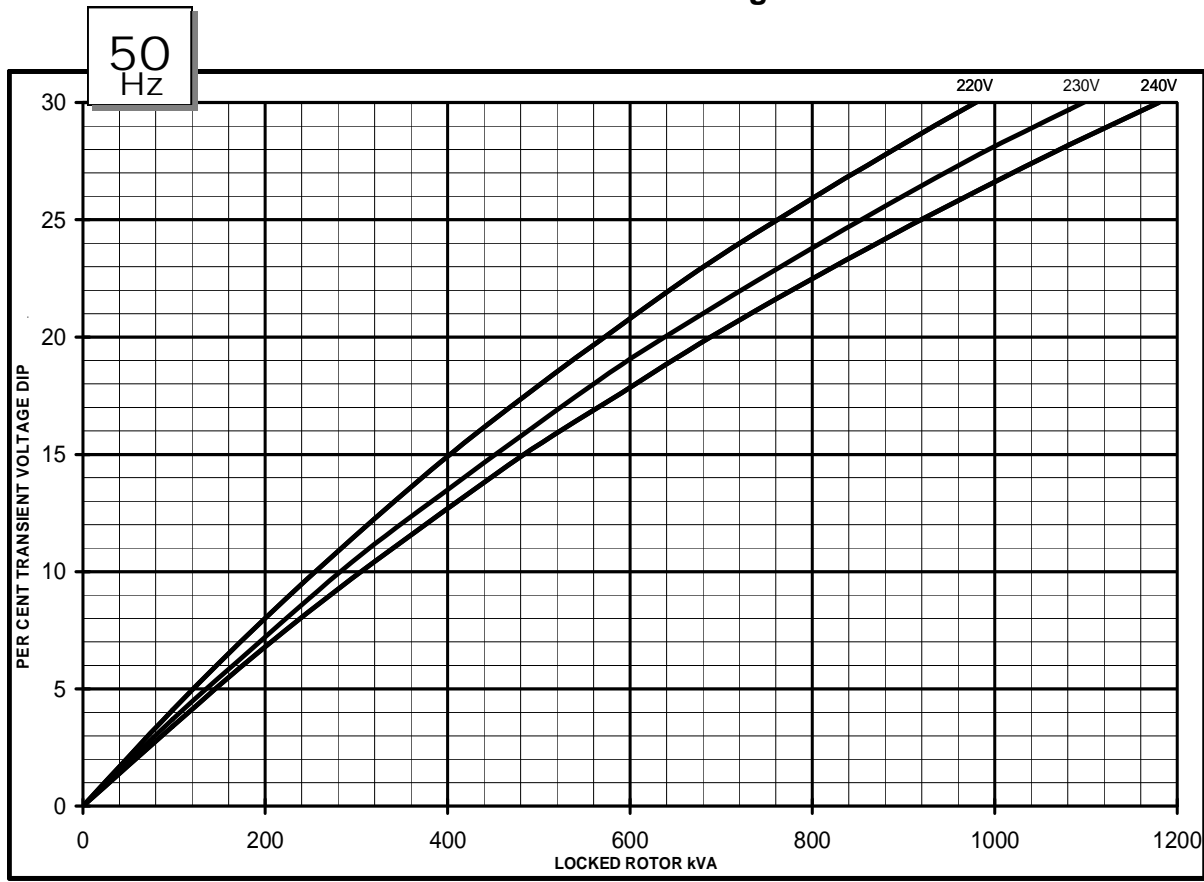

HCM534E



Winding 311 Single Phase

Single Phase Short Circuit Decrement Curve. No-load Excitation at Rated Speed Based on Double Delta connection.

50
Hz

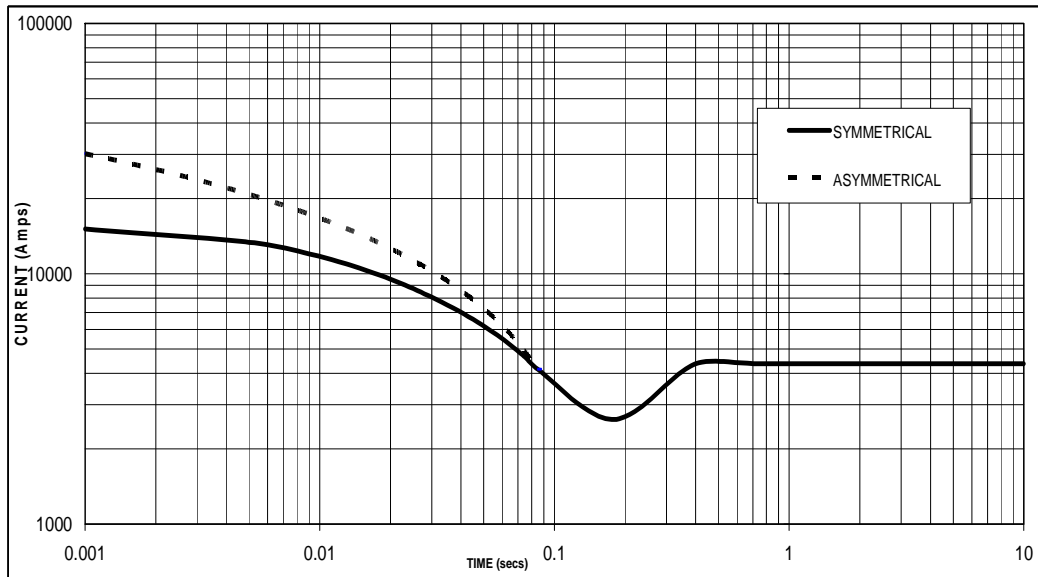

Sustained Short Circuit = 4364 Amps

OVER

60
Hz

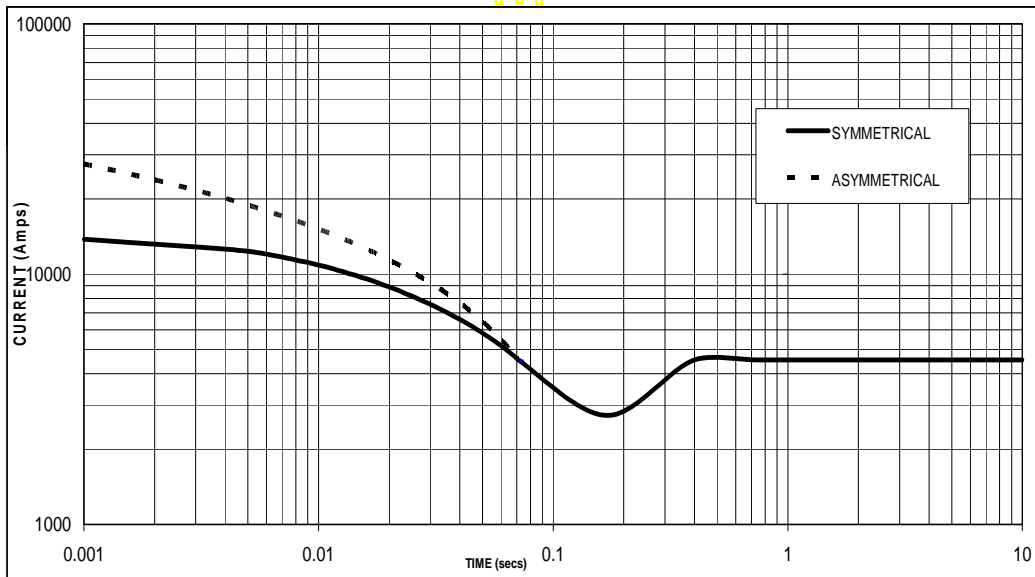

Sustained Short Circuit = 4545 Amps

Note

The following multiplication factors should be used to adjust the values from curve between time 0.001 seconds and the minimum current point in respect of nominal operating voltage :

Voltage	Factor
220V	X 1.00
230V	X 1.05
240V	X 1.09

The sustained current value is constant irrespective of voltage level

Winding 311 Single Phase

RATINGS

50Hz

Class - Temp Rise	Cont. E - 65/50°C 0.8pf			Cont. B - 70/50°C 0.8pf			Cont. F - 90/50°C 0.8pf			Cont. H - 110/50°C 0.8pf		
Double Delta (V)	220	230	240	220	230	240	220	230	240	220	230	240
Parallel Delta (V)	110	115	120	110	115	120	110	115	120	110	115	120
kVA	159	159	159	168	168	168	194	194	194	212	212	212
kW	127	127	127	134	134	134	155	155	155	170	170	170
Efficiency (%)	91.8	91.7	91.5	92.0	91.9	91.7	92.3	92.2	92.1	92.4	92.4	92.3
kW Input	138	138	139	146	146	146	168	168	168	184	184	184

Class - Temp Rise	Cont. E - 65/50°C 1.0pf			Cont. B - 70/50°C 1.0pf			Cont. F - 90/50°C 1.0pf			Cont. H - 110/50°C 1.0pf		
Double Delta (V)	220	230	240	220	230	240	220	230	240	220	230	240
Parallel Delta (V)	110	115	120	110	115	120	110	115	120	110	115	120
kVA	159	159	159	168	168	168	194	194	194	212	212	212
kW	159	159	159	168	168	168	194	194	194	212	212	212
Efficiency (%)	93.6	93.5	93.4	93.7	93.6	93.5	94.0	93.9	93.9	94.1	94.1	94.0
kW Input	170	170	170	179	179	180	206	207	207	225	225	226

60Hz

Class - Temp Rise	Cont. E - 65/50°C 0.8pf			Cont. B - 70/50°C 0.8pf			Cont. F - 90/50°C 0.8pf			Cont. H - 110/50°C 0.8pf		
Double Delta (V)	220	230	240	220	230	240	220	230	240	220	230	240
Parallel Delta (V)	110	115	120	110	115	120	110	115	120	110	115	120
kVA	170	179	188	181	190	198	206	216	225	222	233	243
kW	136	143	150	145	152	158	165	173	180	178	186	194
Efficiency (%)	91.5	91.6	91.7	91.7	91.8	91.8	92.0	92.1	92.1	92.1	92.2	92.3
kW Input	149	156	164	158	166	172	179	188	195	193	202	210

Class - Temp Rise	Cont. E - 65/50°C 1.0pf			Cont. B - 70/50°C 1.0pf			Cont. F - 90/50°C 1.0pf			Cont. H - 110/50°C 1.0pf		
Double Delta (V)	220	230	240	220	230	240	220	230	240	220	230	240
Parallel Delta (V)	110	115	120	110	115	120	110	115	120	110	115	120
kVA	170	179	188	181	190	198	206	216	225	222	233	243
kW	170	179	188	181	190	198	206	216	225	222	233	243
Efficiency (%)	93.3	93.4	93.4	93.4	93.5	93.5	93.7	93.7	93.8	93.8	93.8	93.9
kW Input	182	192	201	194	203	212	220	231	240	237	248	259

DIMENSIONS

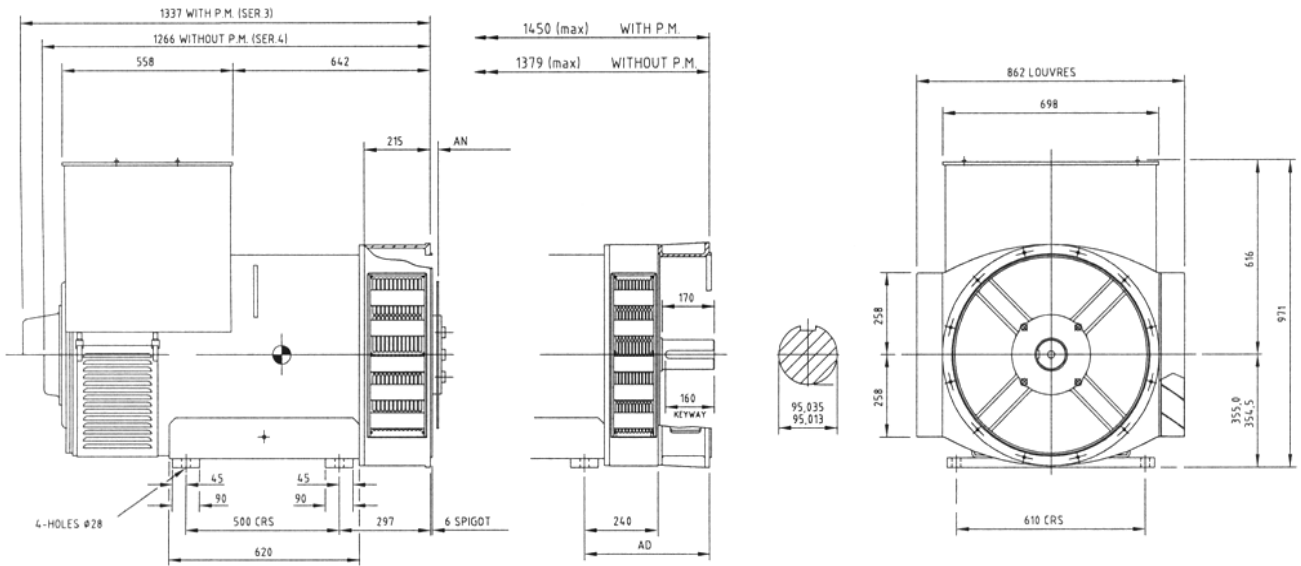

COUPLING DISC	AN
SAE 1/4	25,4
SAE 1/8	15,87
SAE 21	0

ADAPTOR	AD
SAE 00	410
SAE 0	410
SAE 1/2	390
SAE 1	390

DOCUMENT

APPROVED DOCUMENT

STAMFORD

Head Office Address:
Barnack Road, Stamford
Lincolnshire, PE9 2NB
United Kingdom
Tel: +44 (0) 1780 484000
Fax: +44 (0) 1780 484100

www.cumminsgeneratortechnologies.com

Copyright 2010, Cummins Generator Technologies Ltd, All Rights Reserved
Stamford and AvK are registered trade marks of Cummins Generator Technologies Ltd
Cummins and the Cummins logo are registered trade marks of Cummins Inc.