

STAMFORD[®]

PM142H - Winding 311 Single Phase

Technical Data Sheet

APP

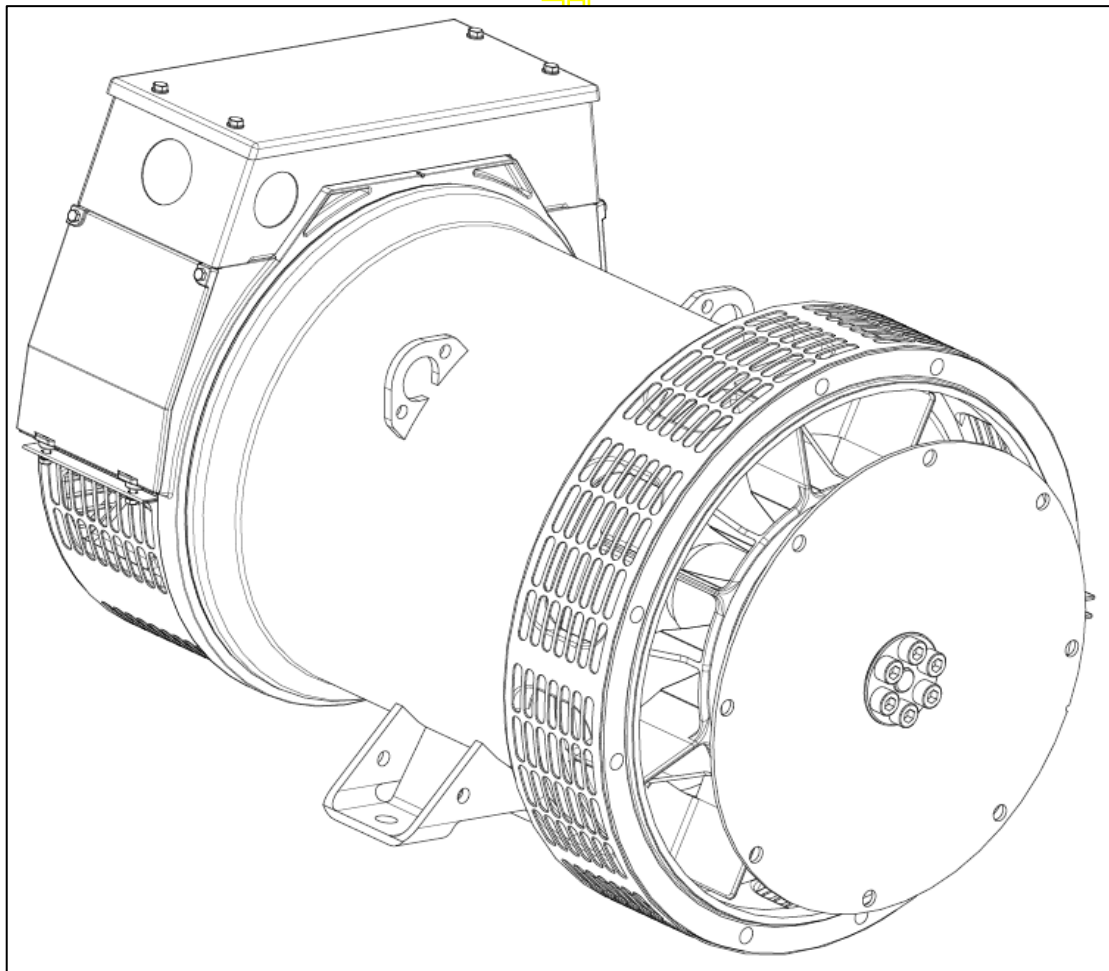

**PM142H
SPECIFICATIONS & OPTIONS**

STANDARDS

Marine generators may be certified to Lloyds, DnV, Bureau Veritas, ABS, Germanischer-Lloyd or RINA. Other standards and certifications can be considered on request.

VOLTAGE REGULATOR

AS480 AVR

With this self-excited system the main stator provides power via the AVR to the exciter stator. The high efficiency semi-conductors of the AVR ensure positive build-up from initial low levels of residual voltage.

The exciter rotor output is fed to the main rotor through a three-phase full-wave bridge rectifier. The rectifier is protected by a surge suppressor against surges caused, for example, by short circuit or out-of-phase paralleling. The AS480 will support limited accessories, RFI suppression remote voltage trimmer and for the P1 range only a 'droop' Current Transformer (CT) to permit parallel operation with other ac generators.

The AVR is can be fitted to either side of the generator in its own housing in the non-drive end bracket.

Excitation Boost System (EBS)

The EBS is a single, self-contained unit, attached to the non-drive end of the generator.

The EBS unit consists of the Excitation Boost Controller (EBC) and an Excitation Boost Generator (EBG). Under fault conditions, or when the generator is subjected to a large impact load such as a motor starting, the generator voltage will drop. The EBC senses the drop in voltage and engages the output power of the EBG. This additional power feeds the generator's excitation system, supporting the load until breaker discrimination can remove the fault or enable the generator to pick up a motor and drive the voltage recovery.

WINDINGS & ELECTRICAL PERFORMANCE

All generator stators are wound to 2/3 pitch. This eliminates triplen (3rd, 9th, 15th ...) harmonics on the voltage waveform and is found to be the optimum design for trouble-free supply of non-linear loads. The 2/3 pitch design avoids excessive neutral currents sometimes seen with higher winding pitches, when in parallel with the mains. A fully connected damper winding reduces oscillations during paralleling. This winding, with the 2/3 pitch and carefully selected pole and tooth designs, ensures very low waveform distortion.

TERMINALS & TERMINAL BOX

Standard generators are reconnectable with 12 ends brought out to the terminals, which are mounted at the non drive end of the generator. Dedicated single phase generators are also available. A sheet steel terminal box contains provides ample space for the customers' wiring and gland arrangements. Alternative terminal boxes are available for customers who want to fit additional components in the terminal box.

SHAFT & KEYS

All generator rotors are dynamically balanced to better than BS6861:Part 1 Grade 2.5 for minimum vibration in operation. Two bearing generators are balanced with a half key.

INSULATION / IMPREGNATION

The insulation system is class 'H'.

All wound components are impregnated with materials and processes designed specifically to provide the high build required for static windings and the high mechanical strength required for rotating components.

QUALITY ASSURANCE

Generators are manufactured using production procedures having a quality assurance level to BS EN ISO 9001.

The stated voltage regulation may not be maintained in the presence of certain radio transmitted signals. Any change in performance will fall within the limits of Criteria 'B' of EN 61000-6-2:2001. At no time will the steady-state voltage regulation exceed 2%.

DE RATES

All values tabulated on page 8 are subject to the following reductions

5% when air inlet filters are fitted.

3% for every 500 metres by which the operating altitude exceeds 1000 metres above mean sea level.

3% for every 5°C by which the operational ambient temperature exceeds 50°C.

Note: Requirement for operating in an ambient exceeding 60°C must be referred to the factory.

5% For reverse rotation

(Standard rotation CW when viewed from DE)

NB Continuous development of our products entitles us to change specification details without notice, therefore they must not be regarded as binding.

Front cover drawing typical of product range.

APPROVED DOCUMENT

WINDING 311 Single Phase

CONTROL SYSTEM	AS480 AVR WITH EXCITATION BOOST SYSTEM (EBS)					
VOLTAGE REGULATION	± 1.0 %					
SUSTAINED SHORT CIRCUIT	REFER TO SHORT CIRCUIT DECREMENT CURVE (page 7)					
INSULATION SYSTEM	CLASS H					
PROTECTION	IP23					
RATED POWER FACTOR	0.8					
STATOR WINDING	DOUBLE LAYER CONCENTRIC					
WINDING PITCH	TWO THIRDS					
WINDING LEADS	12					
STATOR WDG. RESISTANCE	0.102 Ohms AT 22°C DOUBLE DELTA CONNECTED					
ROTOR WDG. RESISTANCE	1.59 Ohms at 22°C					
EXCITER STATOR RESISTANCE	20 Ohms at 22°C					
EXCITER ROTOR RESISTANCE	0.105 Ohms PER PHASE AT 22°C					
EBS STATOR RESISTANCE	12.9 Ohms at 22°C					
R.F.I. SUPPRESSION	BS EN 61000-6-2 & BS EN 61000-6-4, VDE 0875G, VDE 0875N. refer to factory for others					
WAVEFORM DISTORTION	NO LOAD < 1.5% NON-DISTORTING LINEAR LOAD < 5.0%					
MAXIMUM OVERSPEED	4500 Rev/Min					
BEARING DRIVE END	BALL. 6310-2RS (ISO)					
BEARING NON-DRIVE END	BALL. 6306-2RS (ISO)					
	1 BEARING			2 BEARING		
WEIGHT COMP. GENERATOR	172.5 kg			175.5 kg		
WEIGHT WOUND STATOR	85.1 kg			85.1 kg		
WEIGHT WOUND ROTOR	50.86 kg			52.58 kg		
WR ² INERTIA	0.1517 kgm ²			0.1522 kgm ²		
SHIPPING WEIGHTS in a crate	191 kg			200 kg		
PACKING CRATE SIZE	85 x 51 x 67 (cm)			71 x 51 x 67 (cm)		
	50 Hz			60 Hz		
TELEPHONE INTERFERENCE	THF<2%			TIF<50		
COOLING AIR	0.205 m ³ /sec 434 cfm			0.241 m ³ /sec 511 cfm		
VOLTAGE DOUBLE DELTA	220 / 110	230 / 115	240 / 120	220 / 110	230 / 115	240 / 120
VOLTAGE PARALLEL DELTA	110	115	120	110	115	120
kVA BASE RATING FOR REACTANCE VALUES	21.2	21.2	21.2	22.4	23.8	24.7
X _d DIR. AXIS SYNCHRONOUS	1.49	1.37	1.25	2.05	2.00	1.90
X' _d DIR. AXIS TRANSIENT	0.16	0.14	0.13	0.21	0.20	0.19
X'' _d DIR. AXIS SUBTRANSIENT	0.09	0.09	0.08	0.12	0.12	0.12
X _q QUAD. AXIS REACTANCE	0.75	0.68	0.63	1.02	0.99	0.95
X'' _q QUAD. AXIS SUBTRANSIENT	0.17	0.15	0.14	0.24	0.23	0.22
X _L LEAKAGE REACTANCE	0.06	0.06	0.05	0.09	0.08	0.08
X ₂ NEGATIVE SEQUENCE	0.14	0.13	0.11	0.19	0.19	0.18
X ₀ ZERO SEQUENCE	0.06	0.06	0.05	0.09	0.08	0.08
REACTANCES ARE SATURATED						
T' _d TRANSIENT TIME CONST.	0.023 s					
T'' _d SUB-TRANSTIME CONST.	0.006 s					
T' _{do} O.C. FIELD TIME CONST.	0.43 s					
T _a ARMATURE TIME CONST.	0.004 s					
SHORT CIRCUIT RATIO	1/X _d					

50
Hz

STAMFORD

PM142H
Winding 311 Single Phase

SINGLE PHASE EFFICIENCY CURVES

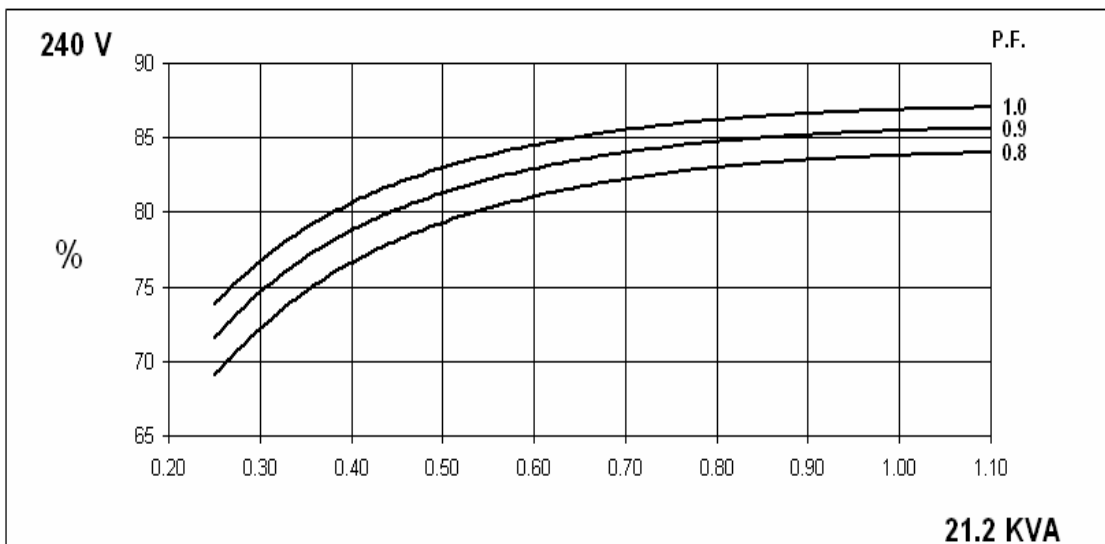
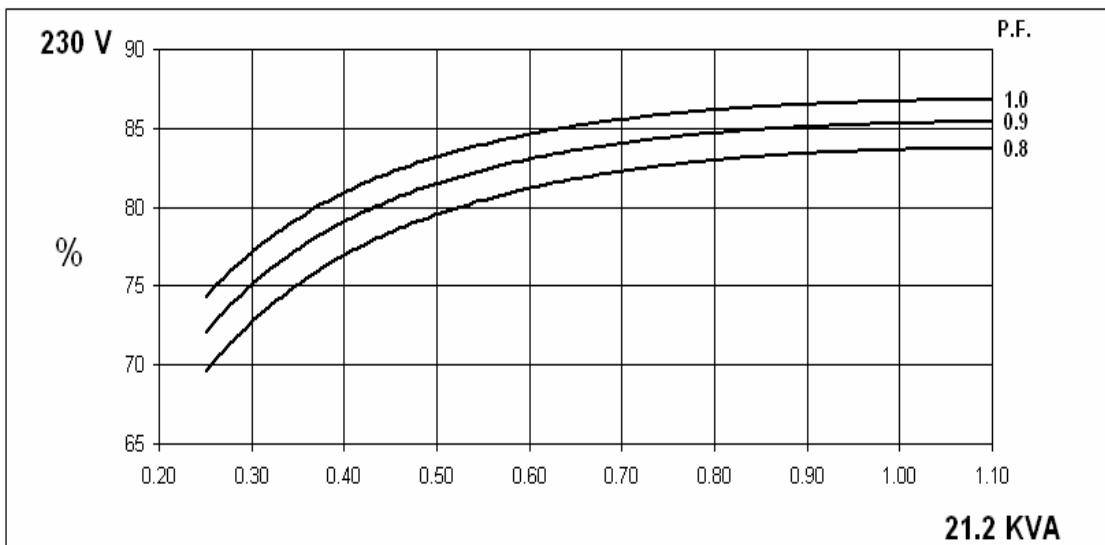
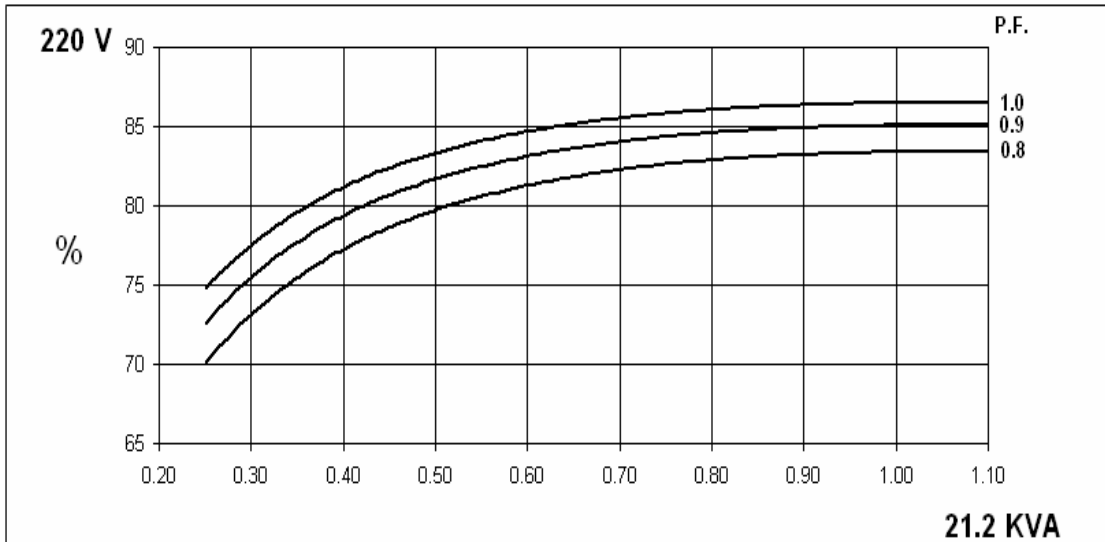

60
Hz

STAMFORD

PM142H
Winding 311 Single Phase

SINGLE PHASE EFFICIENCY CURVES

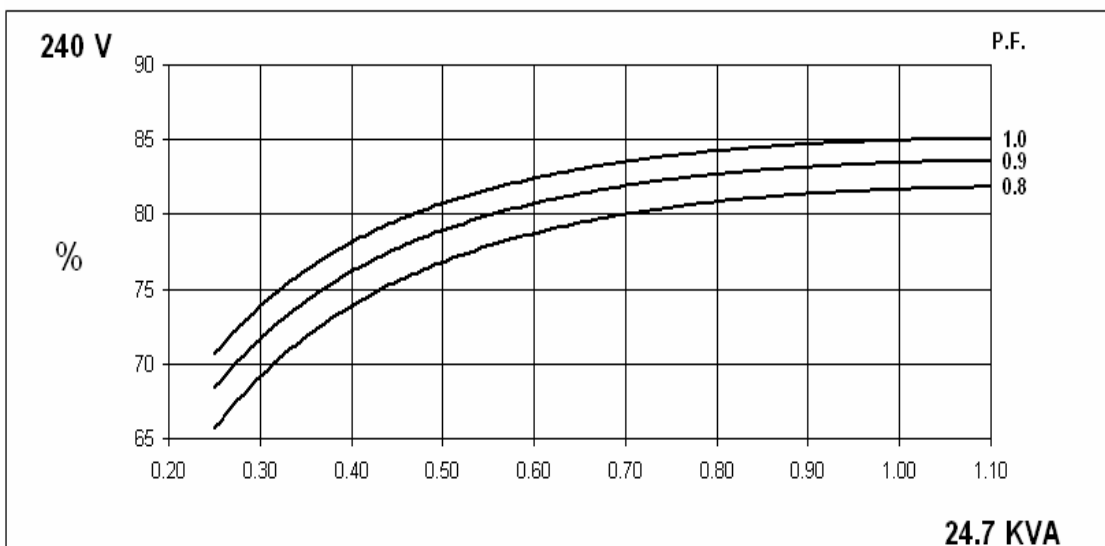
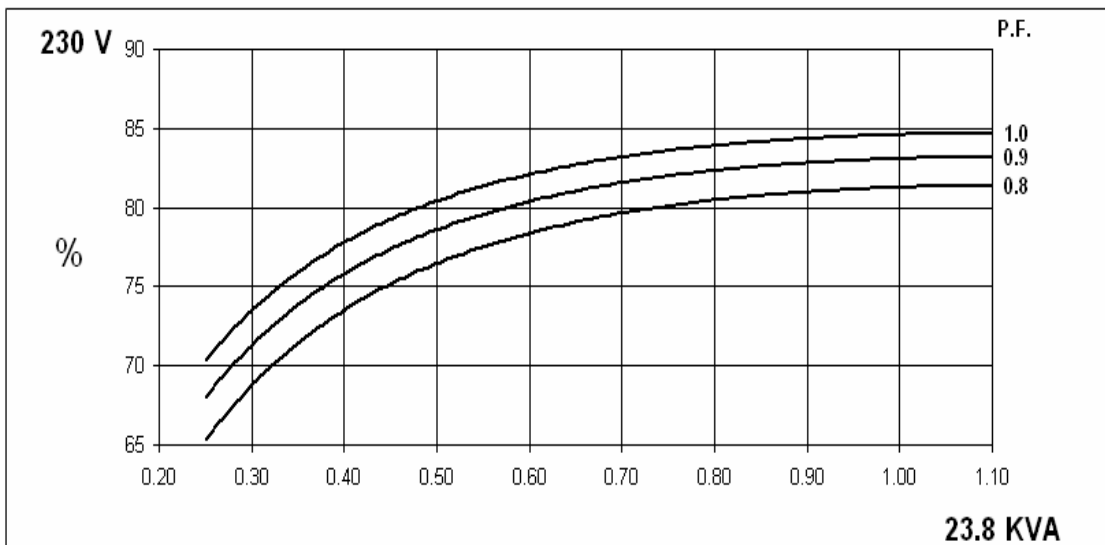
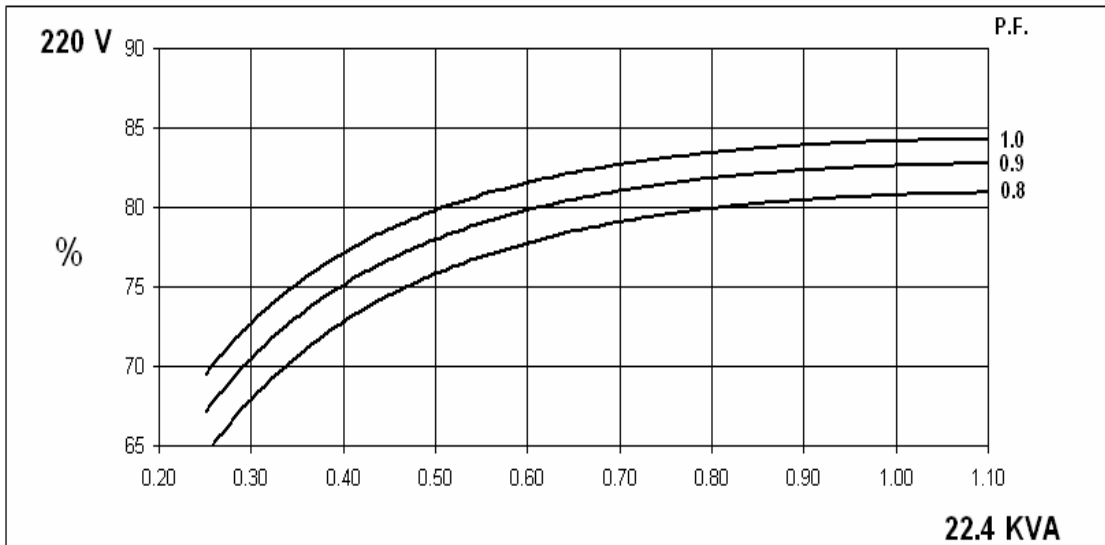

PM142H
Winding 311 Single Phase
AS480 AVR With EBS fitted
Locked Rotor Motor Starting Curves

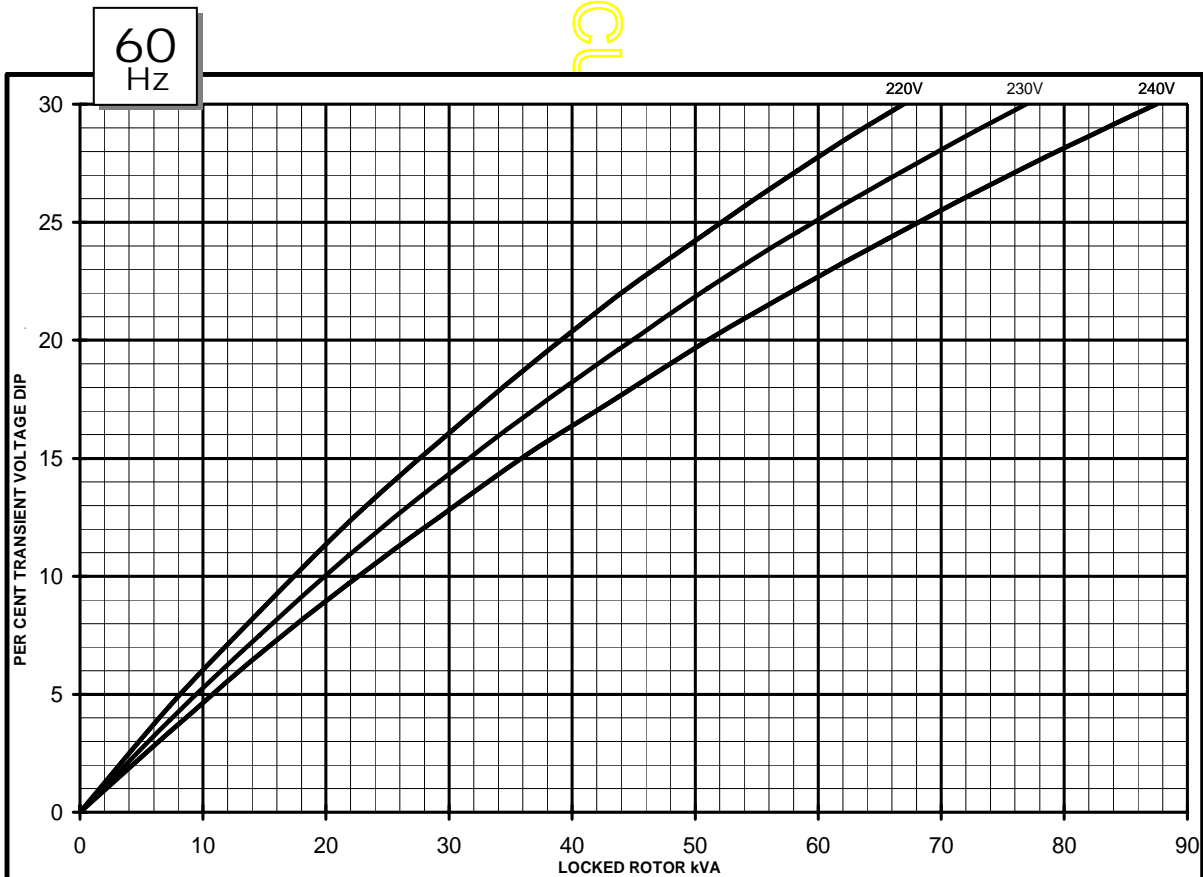
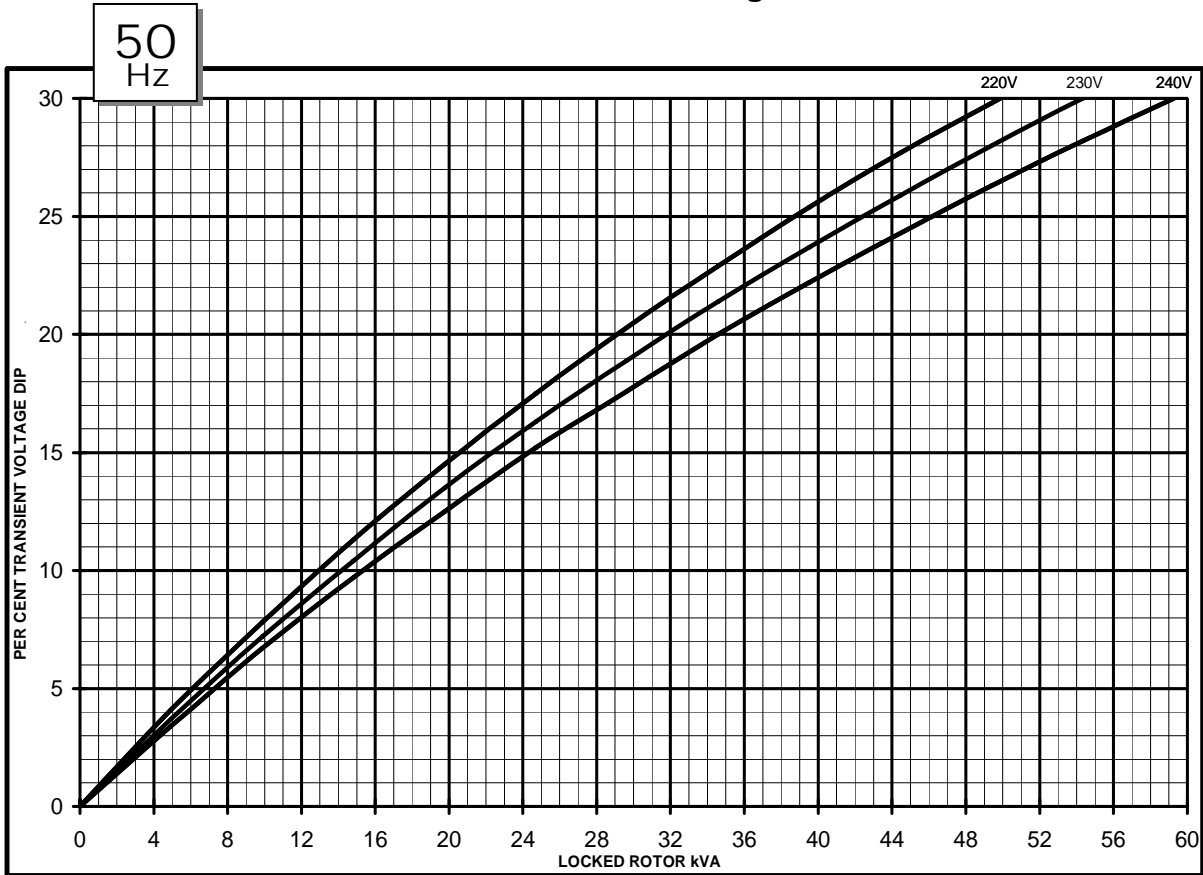

PM142H



Winding 311 Single Phase WITH EBS FITTED

Single-phase Short Circuit Decrement Curve. No-load Excitation at Rated Speed
Based on Double Delta connection.

50
Hz

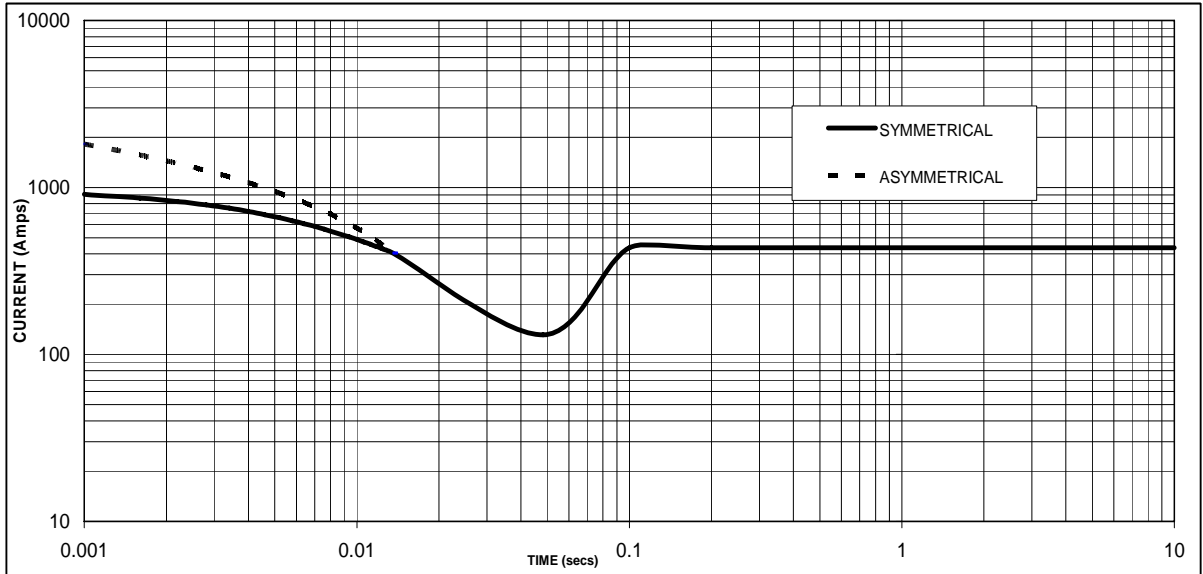

Sustained Short Circuit = 436 Amps



60
Hz

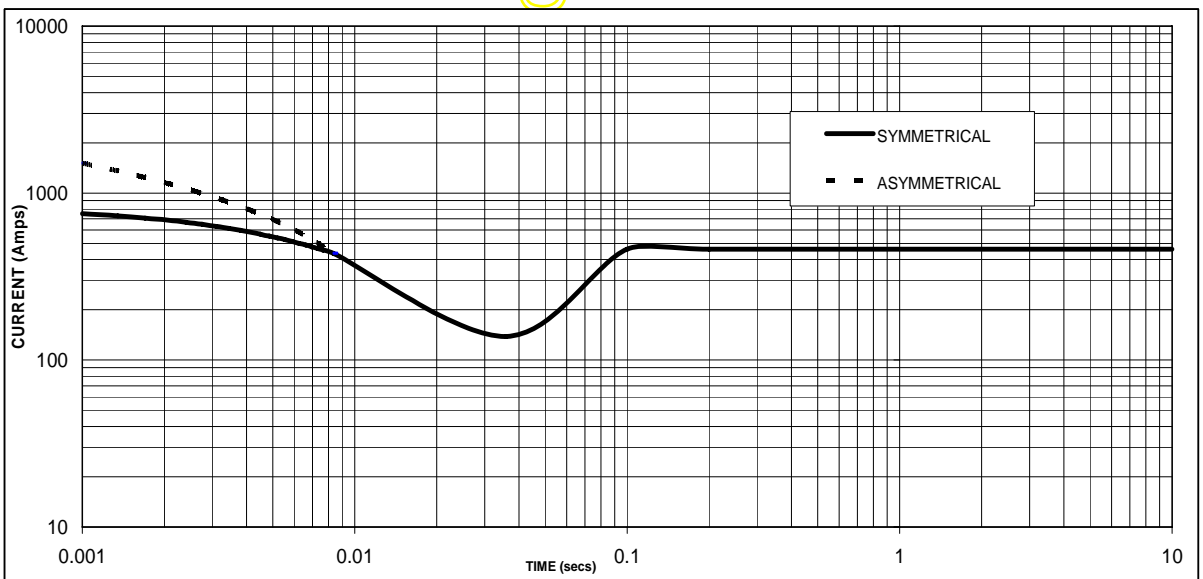

Sustained Short Circuit = 462 Amps

Note

The following multiplication factors should be used to adjust the values from curve between time 0.001 seconds and the minimum current point in respect of nominal operating voltage :

Voltage	Factor
220V	X 1.00
230V	X 1.05
240V	X 1.09

The sustained current value is constant irrespective of voltage level

PM142H
Winding 311 Single Phase

RATINGS

50Hz

Class - Temp Rise	Cont. E - 65/50°C 0.8pf			Cont. B - 70/50°C 0.8pf			Cont. F - 90/50°C 0.8pf			Cont. H - 110/50°C 0.8pf		
Double Delta (V)	220	230	240	220	230	240	220	230	240	220	230	240
Parallel Delta (V)	110	115	120	110	115	120	110	115	120	110	115	120
kVA	16.3	16.3	16.3	16.9	16.9	16.9	19.2	19.2	19.2	21.2	21.2	21.2
kW	13.0	13.0	13.0	13.5	13.5	13.5	15.4	15.4	15.4	17.0	17.0	17.0
Efficiency (%)	82.7	82.8	82.8	82.9	83.0	83.0	83.2	83.4	83.5	83.4	83.6	83.8
kW Input	15.7	15.7	15.7	16.3	16.3	16.3	18.5	18.5	18.4	20.4	20.3	20.3

Class - Temp Rise	Cont. E - 65/50°C 1.0pf			Cont. B - 70/50°C 1.0pf			Cont. F - 90/50°C 1.0pf			Cont. H - 110/50°C 1.0pf		
Double Delta (V)	220	230	240	220	230	240	220	230	240	220	230	240
Parallel Delta (V)	110	115	120	110	115	120	110	115	120	110	115	120
kVA	16.3	16.3	16.3	16.9	16.9	16.9	19.2	19.2	19.2	21.2	21.2	21.2
kW	16.3	16.3	16.3	16.9	16.9	16.9	19.2	19.2	19.2	21.2	21.2	21.2
Efficiency (%)	85.9	86.0	86.0	86.0	86.1	86.2	86.4	86.5	86.6	86.5	86.7	86.9
kW Input	19.0	19.0	19.0	19.7	19.6	19.6	22.2	22.2	22.2	24.5	24.5	24.4

60Hz

Class - Temp Rise	Cont. E - 65/50°C 0.8pf			Cont. B - 70/50°C 0.8pf			Cont. F - 90/50°C 0.8pf			Cont. H - 110/50°C 0.8pf		
Double Delta (V)	220	230	240	220	230	240	220	230	240	220	230	240
Parallel Delta (V)	110	115	120	110	115	120	110	115	120	110	115	120
kVA	17.3	18.3	19.0	17.9	19.0	19.7	20.3	21.5	22.3	22.4	23.8	24.7
kW	13.8	14.6	15.2	14.3	15.2	15.8	16.2	17.2	17.8	17.9	19.0	19.8
Efficiency (%)	79.7	80.2	80.6	79.9	80.4	80.8	80.5	81.0	81.4	80.8	81.3	81.7
kW Input	17.3	18.2	18.9	17.9	18.9	19.6	20.1	21.2	21.9	22.2	23.4	24.2

Class - Temp Rise	Cont. E - 65/50°C 1.0pf			Cont. B - 70/50°C 1.0pf			Cont. F - 90/50°C 1.0pf			Cont. H - 110/50°C 1.0pf		
Double Delta (V)	220	230	240	220	230	240	220	230	240	220	230	240
Parallel Delta (V)	110	115	120	110	115	120	110	115	120	110	115	120
kVA	17.3	18.3	19.0	17.9	19.0	19.7	20.3	21.5	22.3	22.4	23.8	24.7
kW	17.3	18.3	19.0	17.9	19.0	19.7	20.3	21.5	22.3	22.4	23.8	24.7
Efficiency (%)	83.3	83.7	84.0	83.4	83.9	84.2	83.9	84.4	84.7	84.2	84.6	85.0
kW Input	20.8	21.9	22.6	21.5	22.6	23.4	24.2	25.5	26.3	26.6	28.1	29.1

PM142H
Winding 311 Single Phase

DIMENSIONS

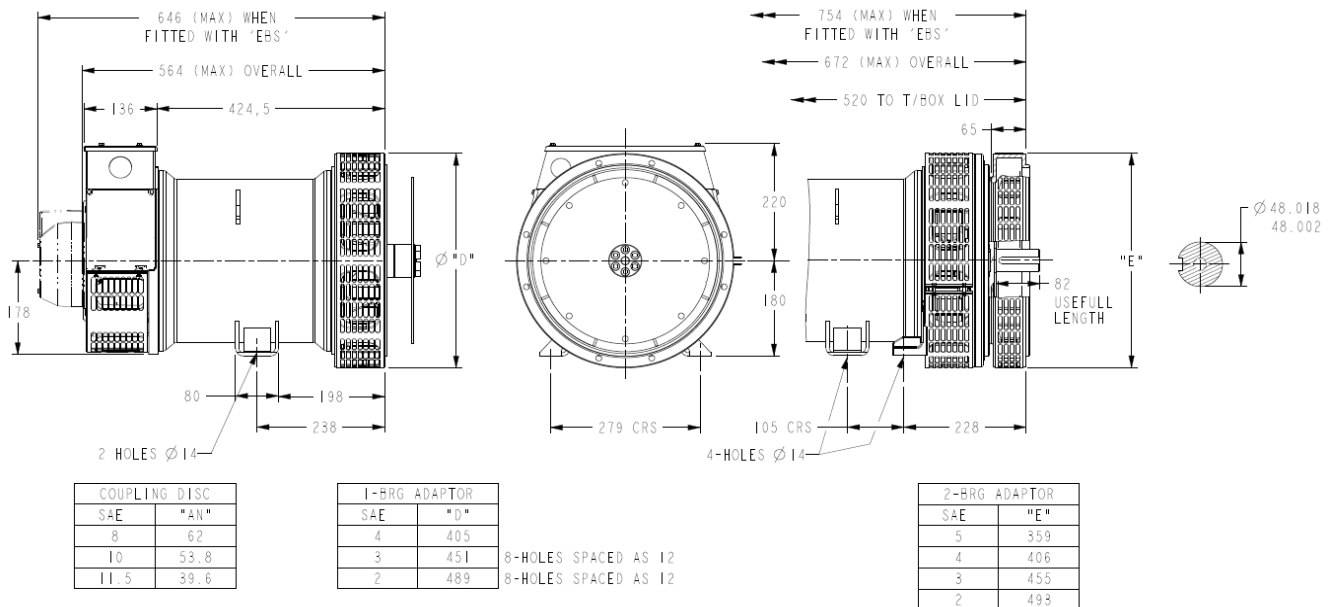

VED DOCUMENT

APPROVED DOCUMENT

STAMFORD

Head Office Address:
Barnack Road, Stamford
Lincolnshire, PE9 2NB
United Kingdom
Tel: +44 (0) 1780 484000
Fax: +44 (0) 1780 484100

www.cumminsgeneratortechnologies.com

Copyright 2010, Cummins Generator Technologies Ltd, All Rights Reserved
Stamford and AvK are registered trade marks of Cummins Generator Technologies Ltd
Cummins and the Cummins logo are registered trade marks of Cummins Inc.