

STAMFORD[®]

HCI634H - Winding 311 and 312

Technical Data Sheet

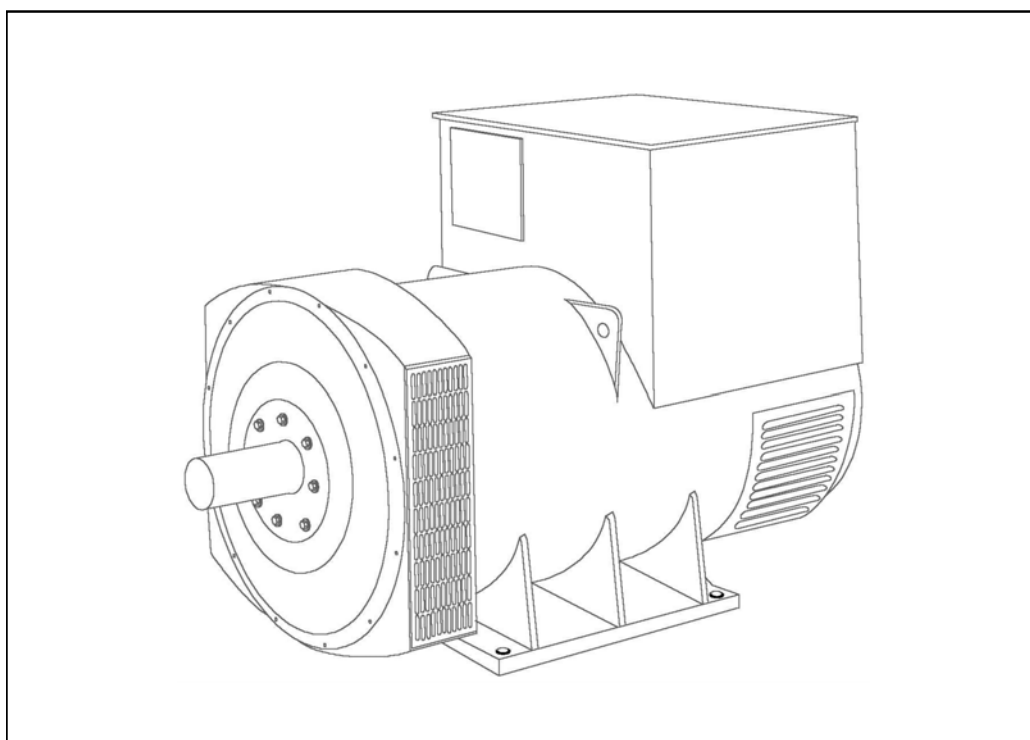

HCI634H

SPECIFICATIONS & OPTIONS

WINDING 311 and 312

STAMFORD

STANDARDS

Stamford industrial generators meet the requirements of BS EN 60034 and the relevant section of other international standards such as BS5000, VDE 0530, NEMA MG1-32, IEC34, CSA C22.2-100, AS1359.

Other standards and certifications can be considered on request.

VOLTAGE REGULATORS

MX321 AVR - STANDARD

This sophisticated Automatic Voltage Regulator (AVR) is incorporated into the Stamford Permanent Magnet Generator (PMG) system and is fitted as standard to generators of this type.

The PMG provides power via the AVR to the main exciter, giving a source of constant excitation power independent of generator output. The main exciter output is then fed to the main rotor, through a full wave bridge, protected by a surge suppressor. The AVR has in-built protection against sustained over-excitation, caused by internal or external faults. This de-excites the machine after a minimum of 5 seconds.

Over voltage protection is built-in and short circuit current level adjustments is an optional facility.

WINDINGS & ELECTRICAL PERFORMANCE

All generator stators are wound to 2/3 pitch. This eliminates triplen (3rd, 9th, 15th ...) harmonics on the voltage waveform and is found to be the optimum design for trouble-free supply of non-linear loads. The 2/3 pitch design avoids excessive neutral currents sometimes seen with higher winding pitches, when in parallel with the mains. A fully connected damper winding reduces oscillations during paralleling. This winding, with the 2/3 pitch and carefully selected pole and tooth designs, ensures very low waveform distortion.

TERMINALS & TERMINAL BOX

Standard generators feature a main stator with either 6 ends (Winding 312) or 12 ends (Winding 311) brought out to the terminals, which are mounted on the frame at the non-drive end of the generator. A sheet steel terminal box contains the AVR and provides ample space for the customers' wiring and gland arrangements. It has removable panels for easy access.

SHAFT & KEYS

All generator rotors are dynamically balanced to better than BS6861:Part 1 Grade 2.5 for minimum vibration in operation. Two bearing generators are balanced with a half key.

INSULATION/IMPREGNATION

The insulation system is class 'H'.

All wound components are impregnated with materials and processes designed specifically to provide the high build required for static windings and the high mechanical strength required for rotating components.

QUALITY ASSURANCE

Generators are manufactured using production procedures having a quality assurance level to BS EN ISO 9001.

The stated voltage regulation may not be maintained in the presence of certain radio transmitted signals. Any change in performance will fall within the limits of Criteria 'B' of EN 61000-6-2:2001. At no time will the steady-state voltage regulation exceed 2%.

DE RATES

All values tabulated on page 8 are subject to the following reductions

5% when air inlet filters are fitted.

10% when IP44 Filters are fitted.

3% for every 500 metres by which the operating altitude exceeds 1000 metres above mean sea level.

3% for every 5 C by which the operational ambient temperature exceeds 40 C.

Note: Requirement for operating in an ambient exceeding 60 C must be referred to the factory.

NB Continuous development of our products entitles us to change specification details without notice, therefore they must not be regarded as binding.

Front cover drawing typical of product range.

HCI634H



WINDING 311 and 312

CONTROL SYSTEM	SEPARATELY EXCITED BY P.M.G.	
A.V.R.	MX321	
VOLTAGE REGULATION	± 0.5 %	With 4% ENGINE GOVERNING
SUSTAINED SHORT CIRCUIT	REFER TO SHORT CIRCUIT DECREMENT CURVES (page 7)	

INSULATION SYSTEM	CLASS H
PROTECTION	IP23
RATED POWER FACTOR	0.8
STATOR WINDING	DOUBLE LAYER LAP
WINDING PITCH	TWO THIRDS
WINDING LEADS	6 (Wdg 312) or 12 (Wdg 311)
STATOR WDG. RESISTANCE	0.003 Ohms PER PHASE AT 22°C STAR CONNECTED
ROTOR WDG. RESISTANCE	1.88 Ohms at 22°C
EXCITER STATOR RESISTANCE	17 Ohms at 22°C
EXCITER ROTOR RESISTANCE	0.079 Ohms PER PHASE AT 22°C
R.F.I. SUPPRESSION	BS EN 61000-6-2 & BS EN 61000-6-4, VDE 0875G, VDE 0875N. refer to factory for others
WAVEFORM DISTORTION	NO LOAD < 1.5% NON-DISTORTING BALANCED LINEAR LOAD < 5.0%
MAXIMUM OVERSPEED	2250 Rev/Min
BEARING DRIVE END	BALL. 6224 (ISO)
BEARING NON-DRIVE END	BALL. 6317 (ISO)

	1 BEARING				2 BEARING			
WEIGHT COMP. GENERATOR	2117 kg				2145 kg			
WEIGHT WOUND STATOR	1010 kg				1010 kg			
WEIGHT WOUND ROTOR	866 kg				821 kg			
WR ² INERTIA	20.0438 kgm ²				19.4965 kgm ²			
SHIPPING WEIGHTS in a crate	2173kg				2180kg			
PACKING CRATE SIZE	183 x 92 x 140(cm)				183 x 92 x 140(cm)			
	50 Hz				60 Hz			
TELEPHONE INTERFERENCE	THF<2%				TIF<50			
COOLING AIR	1.614 m ³ /sec 3420 cfm				1.961 m ³ /sec 4156 cfm			
VOLTAGE STAR	380/220	400/231	415/240	440/254	416/240	440/254	460/266	480/277
VOLTAGE PARALLEL STAR (*)	190/110	200/115	208/120	220/127	208/120	220/127	230/133	240/138
VOLTAGE DELTA	220	230	240	254	240	254	266	277
kVA BASE RATING FOR REACTANCE VALUES	910	940	910	875	1025	1063	1075	1125
X _d DIR. AXIS SYNCHRONOUS	2.99	2.80	2.51	2.15	3.37	3.13	2.89	2.78
X' _d DIR. AXIS TRANSIENT	0.25	0.24	0.21	0.18	0.29	0.27	0.25	0.24
X'' _d DIR. AXIS SUBTRANSIENT	0.18	0.17	0.15	0.13	0.19	0.18	0.17	0.16
X _q QUAD. AXIS REACTANCE	1.77	1.65	1.49	1.27	2.00	1.86	1.72	1.65
X' _q QUAD. AXIS SUBTRANSIENT	0.19	0.18	0.16	0.14	0.22	0.20	0.19	0.18
X _L LEAKAGE REACTANCE	0.09	0.09	0.07	0.06	0.10	0.09	0.08	0.08
X ₂ NEGATIVE SEQUENCE	0.20	0.19	0.17	0.14	0.23	0.21	0.20	0.19
X ₀ ZERO SEQUENCE	0.03	0.02	0.02	0.02	0.03	0.03	0.02	0.02

REACTANCES ARE SATURATED

VALUES ARE PER UNIT AT RATING AND VOLTAGE INDICATED

T' _d TRANSIENT TIME CONST.	0.185
T'' _d SUB-TRANSTIME CONST.	0.025
T' _{do} O.C. FIELD TIME CONST.	2.44
T _a ARMATURE TIME CONST.	0.04
SHORT CIRCUIT RATIO	1/X _d

(*) Parallel Star connection only available with Wdg 311

50
Hz

HCI634H
WINDING 311 and 312

STAMFORD

THREE PHASE EFFICIENCY CURVES

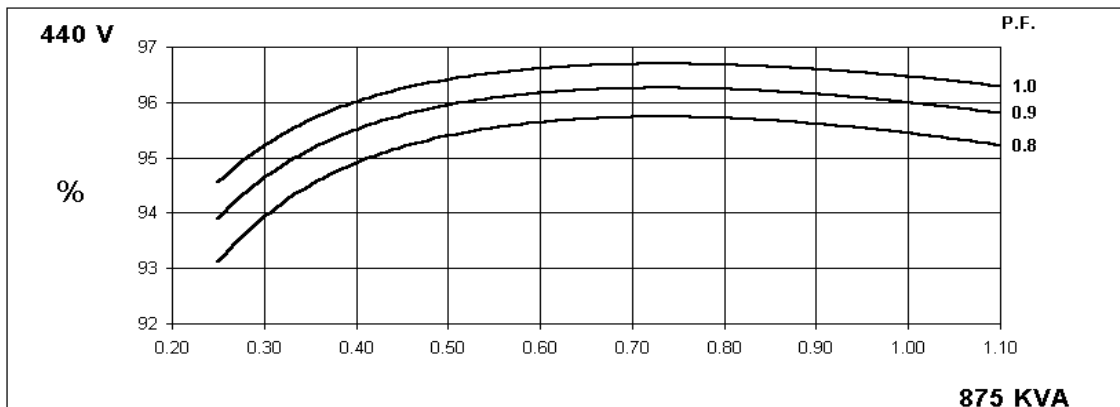
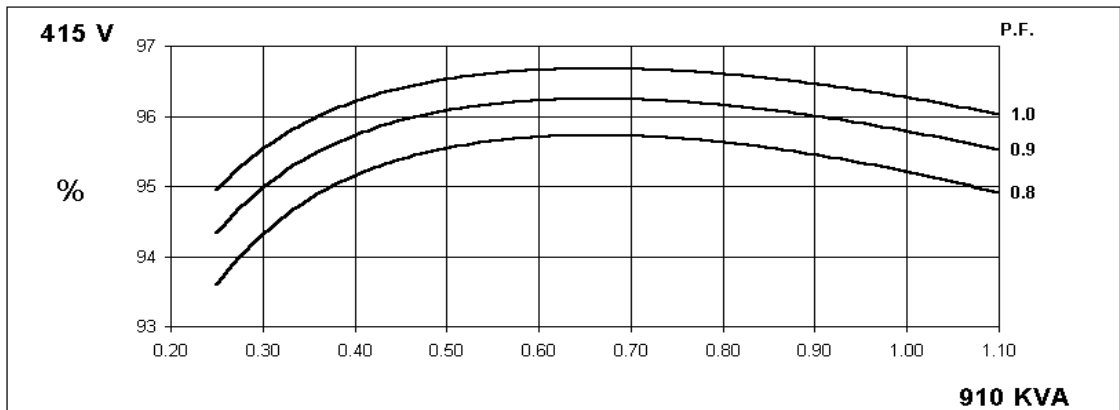
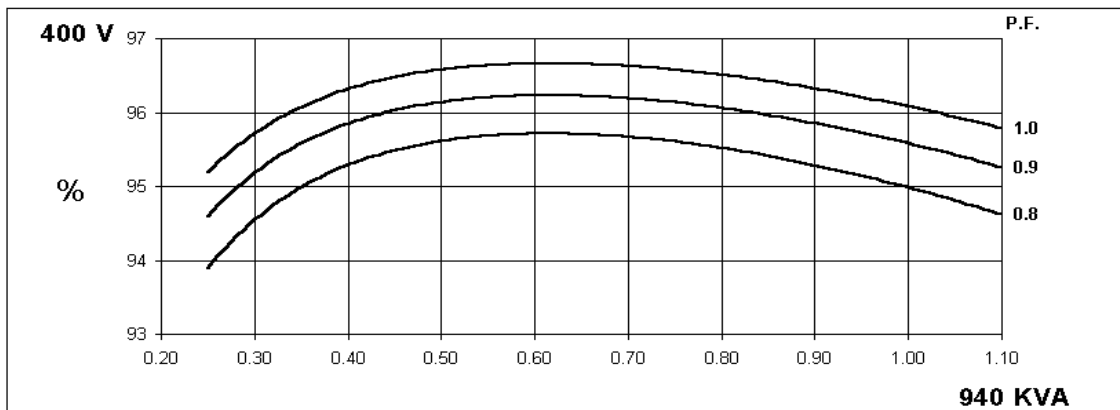
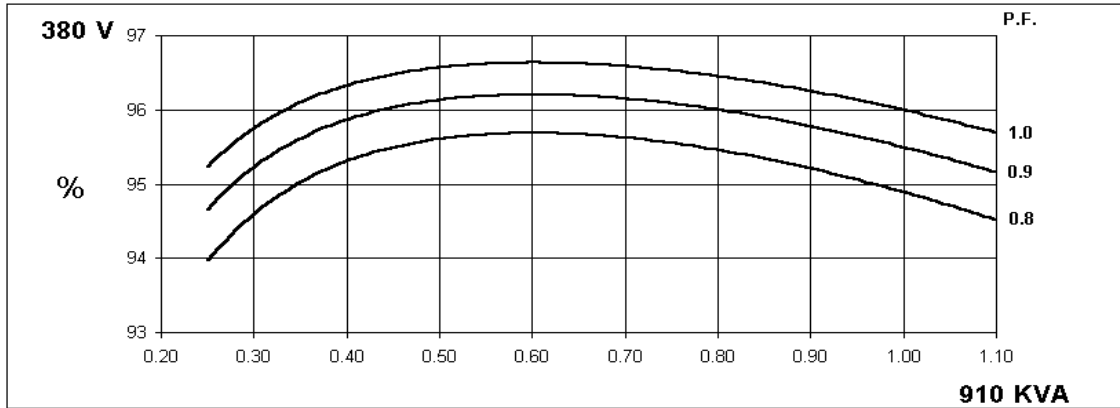

60
Hz

STAMFORD

HCI634H
WINDING 311 and 312

THREE PHASE EFFICIENCY CURVES

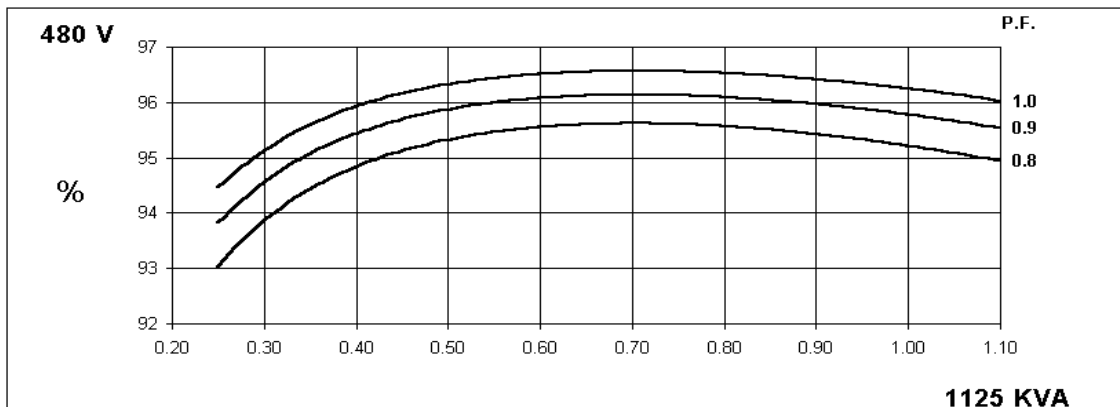
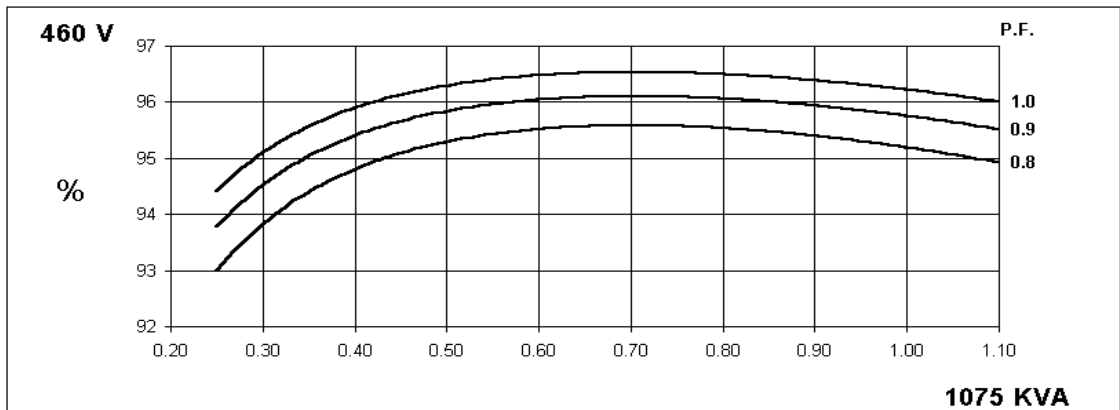
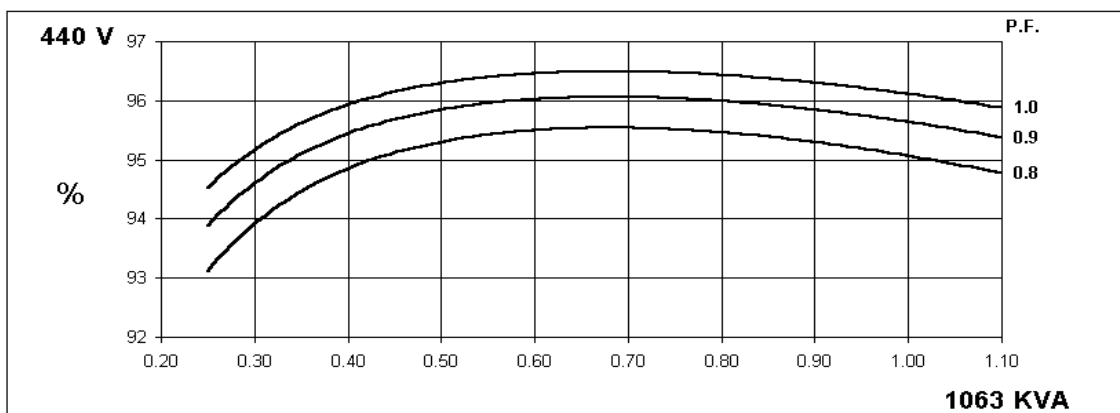
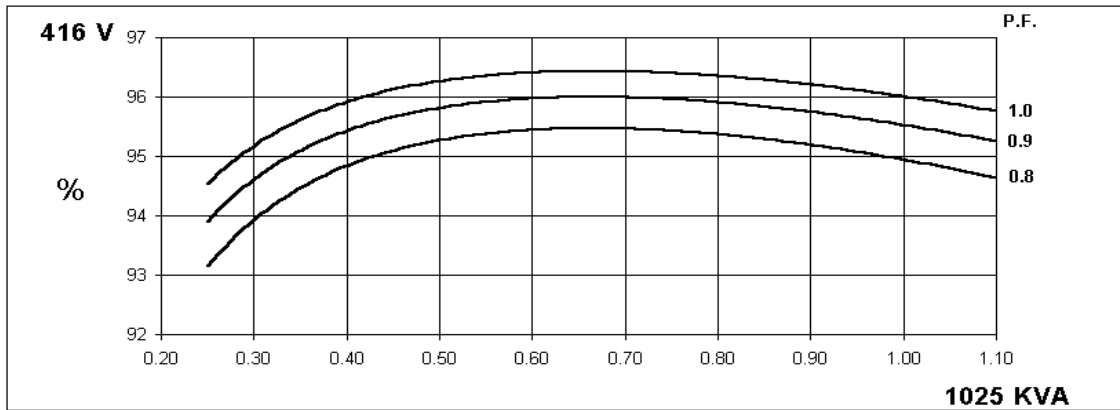

HCI634H
WINDING 311 and 312

Locked Rotor Motor Starting Curve

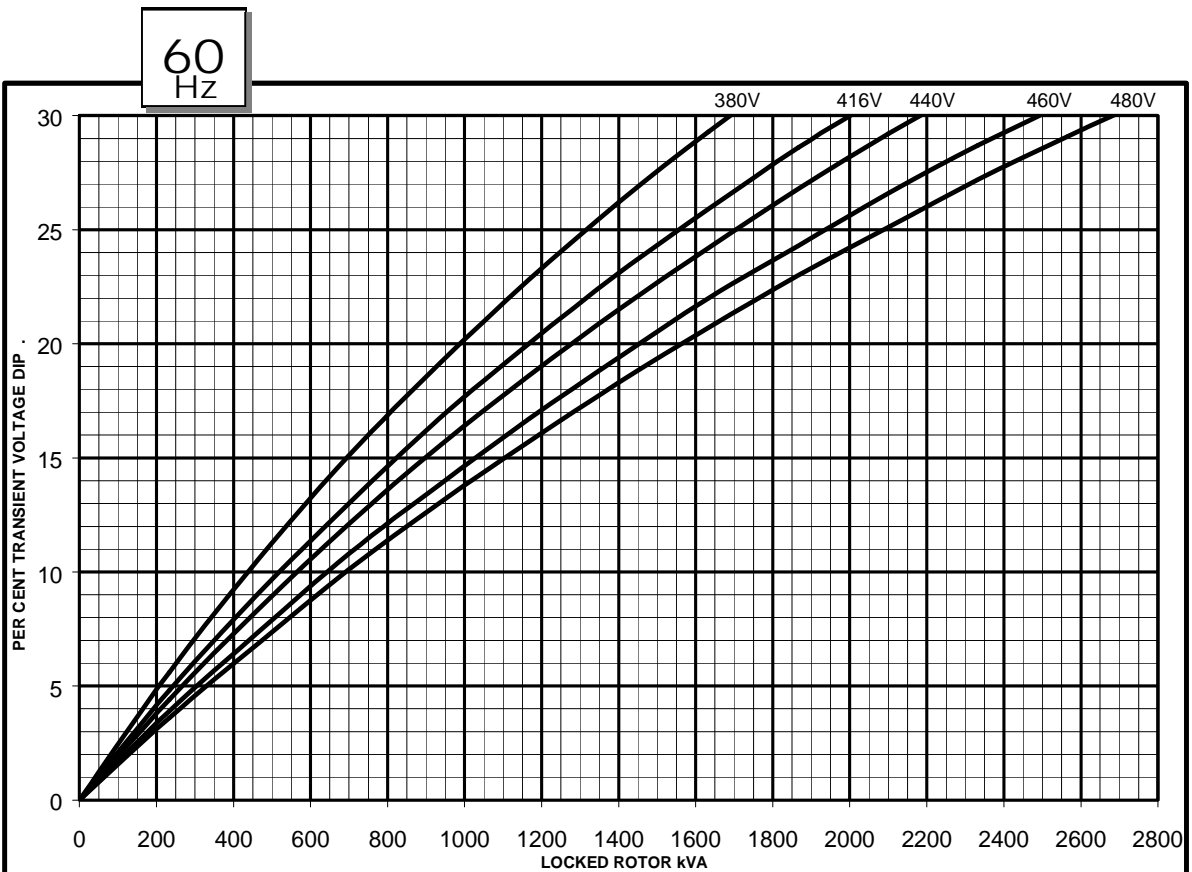
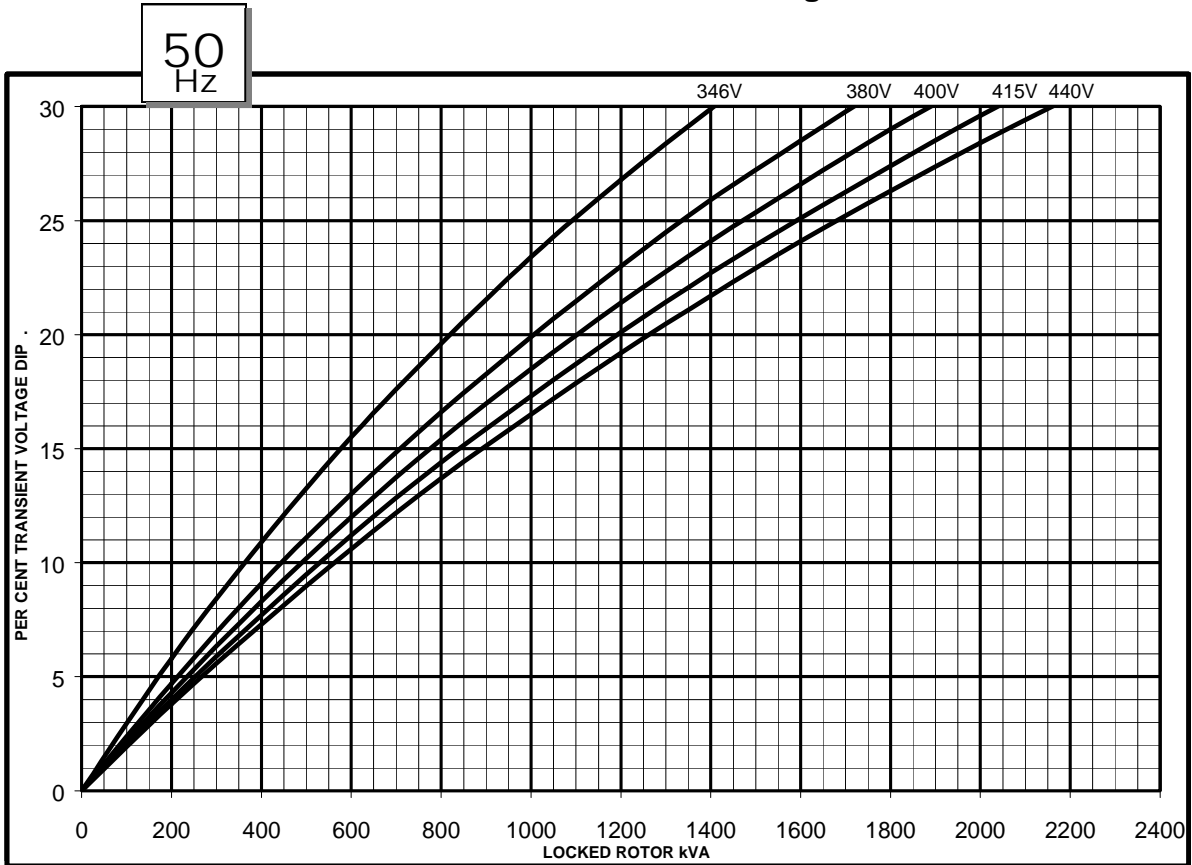

**HCI634H
WINDING 311 and 312**

**Three-phase Short Circuit Decrement Curve. No-load Excitation at Rated Speed
Based on star (wye) connection.**

**50
Hz**

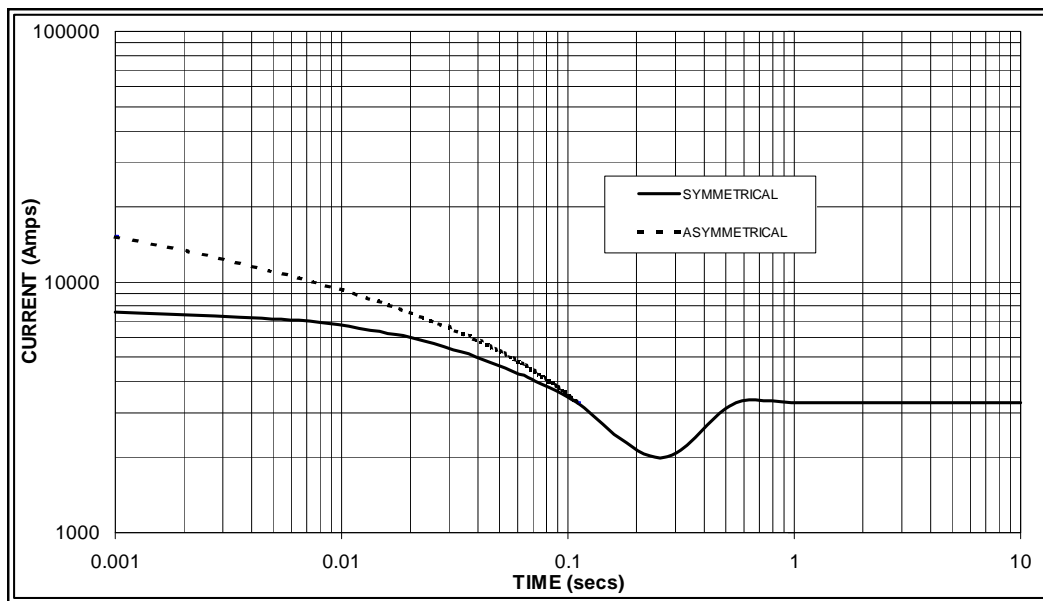

Sustained Short Circuit = 3,300 Amps

**60
Hz**

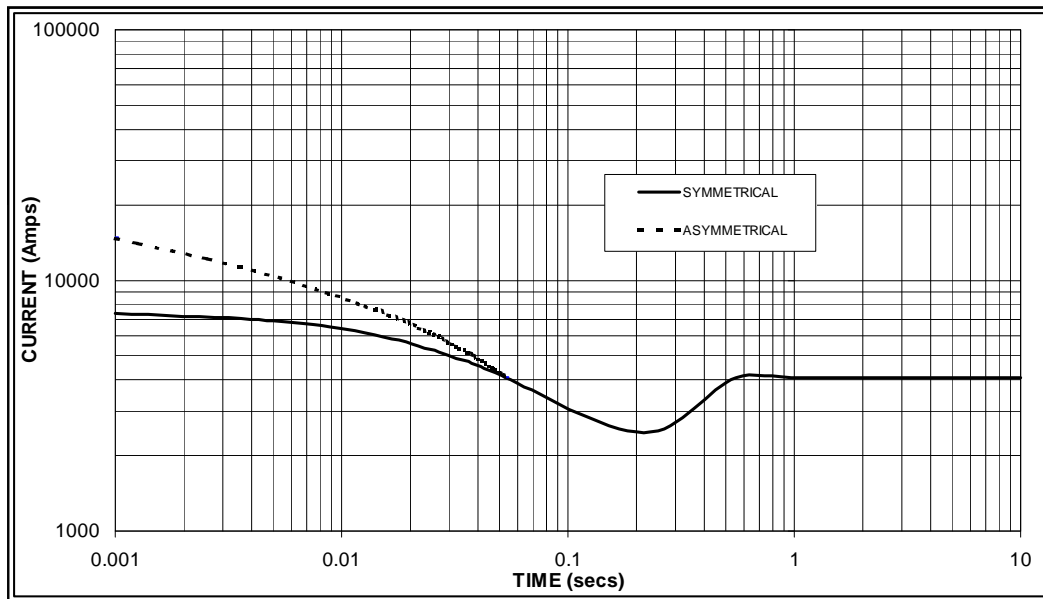

Sustained Short Circuit = 4,000 Amps

Note 1

The following multiplication factors should be used to adjust the values from curve between time 0.001 seconds and the minimum current point in respect of nominal operating voltage :

50Hz		60Hz	
Voltage	Factor	Voltage	Factor
380v	X 1.00	416v	x 1.00
400v	X 1.07	440v	x 1.06
415v	X 1.12	460v	x 1.12
440v	X 1.18	480v	x 1.17

The sustained current value is constant irrespective of voltage level

Note 2

The following multiplication factor should be used to convert the values calculated in accordance with NOTE 1 to those applicable to the various types of short circuit :

	3-phase	2-phase L-L	1-phase L-N
Instantaneous	x 1.00	x 0.87	x 1.30
Minimum	x 1.00	x 1.80	x 3.20
Sustained	x 1.00	x 1.50	x 2.50
Max. sustained duration	10 sec.	5 sec.	2 sec.

All other times are unchanged

Note 3

Curves are drawn for Star (Wye) connected machines.
For Delta connection multiply the Curve current value by 1.732

HCI634H
Winding 311 and 312 0.8 Power Factor

RATINGS

Class - Temp Rise	Cont. F - 105/40°C				Cont. H - 125/40°C				Standby - 150/40°C				Standby - 163/27°C				
50Hz	Star (V)	380	400	415	440	380	400	415	440	380	400	415	440	380	400	415	440
	Parallel Star (V) *	180	200	208	220	180	200	208	220	180	200	208	220	180	200	208	220
	Delta (V)	220	230	240	254	220	230	240	254	220	230	240	254	220	230	240	254
	kVA	830	860	830	800	910	940	910	875	960	980	960	920	1000	1010	1000	960
	kW	664	688	664	640	728	752	728	700	768	784	768	736	800	808	800	768
	Efficiency (%)	95.2	95.3	95.4	95.6	94.9	95.0	95.2	95.4	94.7	94.8	95.1	95.3	94.5	94.7	94.9	95.2
	kW Input	697	722	696	669	767	792	765	734	811	827	808	772	847	853	843	807
60Hz	Star (V)	416	440	460	480	416	440	460	480	416	440	460	480	416	440	460	480
	Parallel Star (V) *	208	220	230	240	208	220	230	240	208	220	230	240	208	220	230	240
	Delta (V)	240	254	266	277	240	254	266	277	240	254	266	277	240	254	266	277
	kVA	913	963	1000	1025	1025	1063	1075	1125	1088	1125	1138	1188	1125	1163	1175	1219
	kW	730	770	800	820	820	850	860	900	870	900	910	950	900	930	940	975
	Efficiency (%)	95.2	95.3	95.3	95.4	94.9	95.1	95.2	95.2	94.8	94.9	95.0	95.1	94.6	94.8	94.9	95.0
	kW Input	767	808	839	860	864	894	903	945	918	948	958	999	951	981	991	1027

* Parallel Star only available with Wdg 311

DIMENSIONS

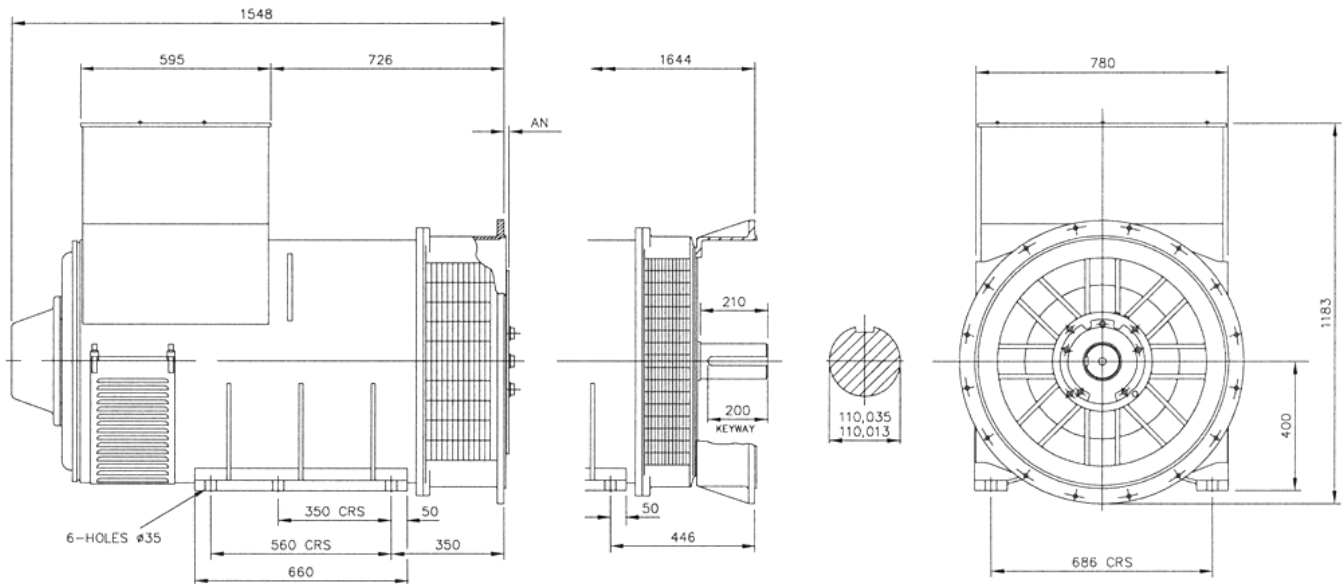

SAE	14	18	21	24
AN	25.4	15.87	0	0

STAMFORD

Head Office Address:
Barnack Road, Stamford
Lincolnshire, PE9 2NB
United Kingdom
Tel: +44 (0) 1780 484000
Fax: +44 (0) 1780 484100

www.cumminsgeneratortechnologies.com

Copyright 2010, Cummins Generator Technologies Ltd, All Rights Reserved
Stamford and AvK are registered trade marks of Cummins Generator Technologies Ltd
Cummins and the Cummins logo are registered trade marks of Cummins Inc.